

53-1002756-01
14 December 2012



Web Tools

Administrator's Guide

Supporting Fabric OS v7.1.0

BROCADE

Copyright © 2006-2012 Brocade Communications Systems, Inc. All Rights Reserved.

Brocade, Brocade Assurance, the B-wing symbol, BigIron, DCX, Fabric OS, FastIron, MLX, NetIron, SAN Health, ServerIron, Turbolron, VCS, and VDX are registered trademarks, and AnyIO, Brocade One, CloudPlex, Effortless Networking, ICX, NET Health, OpenScript, and The Effortless Network are trademarks of Brocade Communications Systems, Inc., in the United States and/or in other countries. Other brands, products, or service names mentioned may be trademarks of their respective owners.

Notice: This document is for informational purposes only and does not set forth any warranty, expressed or implied, concerning any equipment, equipment feature, or service offered or to be offered by Brocade. Brocade reserves the right to make changes to this document at any time, without notice, and assumes no responsibility for its use. This informational document describes features that may not be currently available. Contact a Brocade sales office for information on feature and product availability. Export of technical data contained in this document may require an export license from the United States government.

The authors and Brocade Communications Systems, Inc. shall have no liability or responsibility to any person or entity with respect to any loss, cost, liability, or damages arising from the information contained in this book or the computer programs that accompany it.

The product described by this document may contain "open source" software covered by the GNU General Public License or other open source license agreements. To find out which open source software is included in Brocade products, view the licensing terms applicable to the open source software, and obtain a copy of the programming source code, please visit <http://www.brocade.com/support/oscd>.

Brocade Communications Systems, Incorporated

Corporate and Latin American Headquarters
Brocade Communications Systems, Inc.
130 Holger Way
San Jose, CA 95134
Tel: 1-408-333-8000
Fax: 1-408-333-8101
E-mail: info@brocade.com

Asia-Pacific Headquarters
Brocade Communications Systems China HK, Ltd.
No. 1 Guanghua Road
Chao Yang District
Units 2718 and 2818
Beijing 100020, China
Tel: +8610 6588 8888
Fax: +8610 6588 9999
E-mail: china-info@brocade.com

European Headquarters
Brocade Communications Switzerland Sàrl
Centre Swissair
Tour B - 4ème étage
29, Route de l'Aéroport
Case Postale 105
CH-1215 Genève 15
Switzerland
Tel: +41 22 799 5640
Fax: +41 22 799 5641
E-mail: emea-info@brocade.com

Asia-Pacific Headquarters
Brocade Communications Systems Co., Ltd. (Shenzhen WFOE)
Citic Plaza
No. 233 Tian He Road North
Unit 1308 - 13th Floor
Guangzhou, China
Tel: +8620 3891 2000
Fax: +8620 3891 2111
E-mail: china-info@brocade.com

Document History

Document Title	Publication Number	Summary of Changes	Publication Date
<i>Web Tools User's Guide v2.0</i>	53-0001536-01	N/A	September 1999
<i>Web Tools User's Guide v2.2</i>	53-0001558-02	N/A	May 2000
<i>Web Tools User's Guide v2.3</i>	53-0000067-02	N/A	December 2000
<i>Web Tools User's Guide v3.0</i>	53-0000130-03	N/A	July 2001
<i>Web Tools User's Guide v2.6</i>	53-0000197-02	N/A	December 2001
<i>Advanced Web Tools User's Guide v3.0 / v4.0</i>	53-0000185-02	N/A	March 2002
<i>Advanced Web Tools User's Guide v4.0.2</i>	53-0000185-03	N/A	September 2002
<i>Advanced Web Tools User's Guide v3.1.0</i>	53-0000503-02	N/A	April 2003
<i>Advanced Web Tools User's Guide v4.1.0</i>	53-0000522-02	N/A	April 2003

Document Title	Publication Number	Summary of Changes	Publication Date
<i>Advanced Web Tools User's Guide v4.1.2</i>	53-0000522-04	Insistent Domain ID Mode. Port Swapping information. Minor editorial changes.	October 2003
<i>Advanced Web Tools Administrator's Guide, v4.2.0</i>	53-0000522-05	Updates to support new switch types: Brocade 3250, 3850, 24000. Structural changes, support changes, installation changes.	December 2003
<i>Advanced Web Tools User's Guide</i>	53-0000522-06	Clarifications on software and hardware support, minor enhancements in procedure text, minor rearranging of content.	March 2004
<i>Advanced Web Tools Administrator's Guide</i>	53-0000522-07	Updates to support new switch types (3016, 4100) and Fabric OS v4.4.0, including Ports on Demand, user administration, and zoning wizards.	September 2004
<i>Web Tools Administrator's Guide</i>	53-0000522-08	Updates to support new switch types (200E, 48000) and Fabric OS v5.0.1, including switchAdmin role, upfront login, and Web Tools EZ.	April 2005
<i>Web Tools Administrator's Guide</i>	53-0000522-09	Updates to add additional information about refresh and polling rates.	July 2005
<i>Web Tools Administrator's Guide</i>	53-1000049-01	Updates to support new switch types (4900, 7500) and Fabric OS v5.1.0, including FCR, FCIP, and the FR4-18i port blade. Web Tools EZ information is moved to a separate book.	January 2006
<i>Web Tools Administrator's Guide</i>	53-1000049-02	Updates to the FCIP chapter to clarify how to configure tunnels.	April 2006
<i>Web Tools Administrator's Guide</i>	53-1000194-01	Updates for Fabric OS v5.2.0 and the FC4-16IP blade. Also new security for Web Tools, including Role-Based Access Control and administrative domains.	September 2006
<i>Web Tools Administrator's Guide</i>	53-1000435-01	Updates to reflect interface enhancements, support for new switch types, IPv6 support, and other enhancements.	June 2007
<i>Web Tools Administrator's Guide</i>	53-1000606-01	Updates to reflect updates to enhanced Access Gateway support, changes to FCIP tunneling wizard, and other enhancements.	October 2007
<i>Web Tools Administrator's Guide</i>	53-1000606-02	Updates for support for new switches, traffic isolation zoning, F_Port trunking, removal of enhanced Access Gateway support, and other enhancements.	March 2008
<i>Web Tools Administrator's Guide</i>	53-1001080-01	Updates to add features that require the Enhanced Group Management license, removal of features that are now available from the Brocade Network Advisor.	July 2008
<i>Web Tools Administrator's Guide</i>	53-1001133-01	Updates to add support for Brocade Encryption Switch and FS8-18 Encryption Blade.	August 2008

Document Title	Publication Number	Summary of Changes	Publication Date
<i>Web Tools Administrator's Guide</i>	53-1001194-01	Updates to add support for Virtual Fabrics, IPsec, and consistency with Brocade Network Advisor.	November 2008
<i>Web Tools Administrator's Guide</i>	53-1001343-01	Updates to add support for Brocade 7800 Extension Switch, Brocade 8000, FCOE10-24 DCX Blade, and FX8-24 DCX Extension Blade.	July 2009
<i>Web Tools Administrator's Guide</i>	53-1001772-01	Updates to add support for Brocade Fabric OS 6.4.0.	March 2010
<i>Web Tools Administrator's Guide</i>	53-1002152-01	Updates to add support for Brocade Fabric OS 7.0.0.	April 2011
<i>Web Tools Administrator's Guide</i>	53-1002756-01	Updates to add support for Brocade Fabric OS 7.1.0.	December 2012

Contents

Figures

Tables

About This Document

How this document is organized	xxi
Supported hardware and software	xxii
What's new in this document.	xxiii
Document conventions.	xxiv
Text formatting	xxiv
Notes, cautions, and warnings	xxv
Key terms	xxv
Notice to the reader	xxv
Additional information.	xxvi
Brocade resources.	xxvi
Other industry resources.	xxvi
Getting technical help.	xxvi
Document feedback	xxvii

Chapter 1

Introducing Web Tools

Web Tools overview	1
Web Tools, the EGM license, and Brocade Network Advisor	1
Web Tools features enabled by the EGM license.	2
Web Tools functionality moved to Brocade Network Advisor	3
System requirements	4
Setting refresh frequency for Internet Explorer	5
Deleting temporary internet files used by Java applications	6
Java installation on the workstation	7
Installing the JRE on your Solaris or Linux client workstation.	7
Installing patches on Solaris.	7
Installing the Java plug-in on Windows.	8
Java plug-in configuration.	8
Configuring the Java plug-in for Windows.	8
Configuring the Java Plug-in for Mozilla family browsers	8
Value line licenses.	9

Opening Web Tools	10
Logging in	11
Logging out	13
Role-Based Access Control	13
Session management	14
Ending a Web Tools session	14
Web Tools system logs	15
Technical SupportSave logs	15
Requirements for IPv6 support	16

Chapter 2

Using the Web Tools Interface

Viewing Switch Explorer	17
Persisting GUI preferences	19
Tabs	20
Fabric Tree	20
Switch View buttons	21
Switch View	21
Switch Events and Switch Information	23
Free Professional Management tool	24
Displaying tool tips	24
Right-click options	25
Refresh rates	25
Displaying switches in the fabric	26
Working with Web Tools: recommendations	26
Opening a Telnet or SSH client window	27
Collecting logs for troubleshooting	28

Chapter 3

Managing Fabrics and Switches

Fabric and switch management overview	29
Opening the Switch Administration window	31
Configuring IP and subnet mask information	31
Configuring Netstat Auto Refresh	32
Configuring a syslog IP address	32
Removing a syslog IP address	32
Configuring IP Filtering	33
Blade management	33
Enabling or disabling a blade	34
Setting a slot-level IP address	34
Viewing IP addresses	35

Switch configuration	35
Enabling and disabling a switch	35
Enabling and disabling switch persistent.	36
Changing the switch name	36
Changing the switch domain ID	37
Viewing and printing a switch report	37
Setting a principal switch	37
Switch restart	38
Performing a fast boot.	38
Performing a reboot.	39
System configuration parameters	39
WWN-based Persistent PID assignment.	39
Configuring fabric settings	40
Enabling insistent domain ID mode	41
Configuring virtual channel settings.	41
Configuring arbitrated loop parameters.	42
Configuring system services	42
Configuring signed firmware	43
Licensed feature management	43
Activating a license on a switch	43
Assigning slots for a license key	44
Removing a license from a switch	44
Universal time-based licensing.	45
High Availability overview	45
Launching the High Availability window	45
Synchronizing services on the CP.	46
Initiating a CP failover	47
Event monitoring.	47
Displaying Switch Events.	49
Filtering Switch Events.	49
Filtering events by event severity levels	49
Filtering events by message ID	50
Filtering events by service component.	50
Displaying the Name Server entries	50
Printing the Name Server entries	51
Displaying Name Server information for a particular device	51
Displaying zone members for a particular device	51
Physically locating a switch using beaconing	52
Locating logical switches using chassis beaconing	52
Virtual Fabrics overview	52
Selecting a logical switch from the Switch View	53
Viewing logical ports	53

Chapter 4

Maintaining Configurations and Firmware

Creating a configuration backup file	55
Restoring a configuration	56
Uploading and downloading from USB storage.	57

Performing a firmware download	57
--	----

Chapter 5

Managing Ports

Port management overview	59
Opening the Port Admin tab	60
Port Admin tab components	60
Controllable ports	63
Configuring FC ports	64
Allowed port types	65
Long distance mode	65
Ingress rate limit	66
Assigning a name to a port	67
Port beaconing	68
Enabling and disabling a port	68
Considerations for enabling or disabling a port	69
Persistent enabling and disabling ports	69
Configuring NPIV ports	70
Port activation	71
Enabling Ports on Demand	72
Enabling Dynamic Ports on Demand	72
Disabling Dynamic Ports on Demand	73
Diagnostic ports	73
Reserving and releasing licenses on a port basis	74
Port swapping index	74
Port swapping	75
Determining if a port index was swapped with another switch port	75
Configuring BB credits on an F_Port	76
Configuring ALPA	77
Configuring port octet speed combination	78
Configuring CSCTL	80
Configuring compression and encryption	81
Enabling/disabling encryption	81
Enabling/disabling compression	81
Displaying compression ratio	82
Forward Error Correction	82
Inband Management	82
GigE port modes	84

Chapter 6

Enabling ISL Trunking

ISL Trunking overview	85
Disabling or enabling ISL Trunking	85
Viewing trunk group information	86

F_Port trunk groups	87
Creating and maintaining F_Port trunk groups	87

Chapter 7

Monitoring Performance

Performance Monitor overview	89
Basic monitoring	89
Advanced monitoring	90
Performance graphs	90
Predefined performance graphs	90
User-defined graphs	93
Canvas configurations	93
Opening the Performance Monitor window	94
Creating basic performance monitor graphs	94
Customizing basic monitoring graphs	95
Advanced performance monitoring graphs	97
Creating SID-DID Performance graphs	97
Creating the SCSI vs. IP Traffic graph	98
Creating SCSI command graphs	98
Tunnel and TCP performance monitoring graphs	99
Tunnel and TCP graph chart properties	100
Saving graphs to a canvas	100
Adding graphs to an existing canvas	101
Printing graphs	101
Modifying graphs	101

Chapter 8

Administering Zoning

Zoning overview	103
Basic zones	103
Traffic Isolation zones	103
LSAN zone requirements	104
QoS zone requirements	104
Zoning configurations	104
Opening the Zone Admin window	104
Setting the default zoning mode	105

Zoning management	105
Refreshing fabric information	107
Refreshing Zone Administration window information	108
Saving local zoning changes	108
Selecting a zoning view	109
Creating and populating zone aliases	109
Adding and removing members of a zone alias.	110
Renaming zone aliases	111
Deleting zone aliases.	111
Creating and populating zones	111
Adding and removing members of a zone	112
Renaming zones.	113
Cloning zones.	113
Deleting zones	114
Creating and populating enhanced traffic isolation zones	114
Zone configuration and zoning database management	115
Creating zone configurations	116
Adding or removing zone configuration members.	116
Renaming zone configurations	117
Cloning zone configurations	117
Deleting zone configurations	117
Enabling zone configurations	118
Disabling zone configurations.	118
Displaying enabled zone configurations.	119
Viewing the enabled zone configuration name without opening the Zone Administration window	119
Viewing detailed information about the enabled zone configuration	119
Adding a WWN to multiple aliases and zones	120
Removing a WWN from multiple aliases and zones	120
Replacing a WWN in multiple aliases and zones.	121
Searching for zone members	121
Clearing the zoning database	122
Zone configuration analysis	122
Best practices for zoning	122

Chapter 9

Working with Diagnostic Features

Trace dumps	123
How a trace dump is used.	124
Setting up automatic trace dump transfers.	124
Specifying a remote server	124
Enabling automatic transfer of trace dumps	124
Disabling automatic trace uploads.	125
Displaying switch information	125
Viewing detailed fan hardware status	126
Viewing the temperature status	126
Viewing the power supply status.	127
Checking the physical health of a switch.	127
Defining Switch Policy.	128

	Port LED interpretation	130
	Port icon colors	130
Chapter 10	Using the FC-FC Routing Service	
	Fibre Channel Routing overview.	131
	Supported switches for Fibre Channel Routing.	132
	Setting up FC-FC routing.	132
	FC-FC routing management	133
	Opening the FC Routing module.	133
	Viewing and managing LSAN fabrics	134
	Viewing EX-Ports	134
	Configuring an EX-Port	135
	Editing the configuration of an EX-Port	135
	Configuring FCR router port cost	136
	Viewing LSAN zones	136
	Viewing LSAN devices	136
	Configuring the backbone fabric ID	137
Chapter 11	Using the Access Gateway	
	Access Gateway overview	139
	Viewing Switch Explorer for Access Gateway mode	139
	Access Gateway mode	140
	Restricted access in the Port Admin tab	141
	Enabling Access Gateway mode.	141
	Disabling Access Gateway mode	142
	Viewing the Access Gateway settings	142
	Port configuration	142
	Creating port groups	143
	Editing or viewing port groups.	143
	Deleting port groups	144
	Defining custom primary F-N port mapping.	144
	Defining custom static F-N port mapping.	145
	Defining custom WWN-N port mappings	145
	Access Gateway policy modification	146
	Path Failover and Failback policies	146
	Modifying Path Failover and Failback policies.	146
	Enabling the Automatic Port Configuration policy.	146
	Access Gateway limitations on the Brocade 8000	148
Chapter 12	Administering Fabric Watch	
	Fabric Watch overview	149

Chapter 13	Administering Extended Fabrics	
	Extended link buffer allocation overview	151
	Configuring a port for long distance	154
Chapter 14	Routing Traffic	
	Routing overview	157
	Viewing fabric shortest path first routing	158
	Configuring dynamic load sharing	159
	Lossless dynamic load sharing	159
	Specifying frame order delivery	160
	Configuring the link cost for a port	160
Chapter 15	Configuring Standard Security Features	
	User-defined accounts	163
	Virtual Fabrics considerations	164
	Viewing user account information	165
	Creating user-defined accounts	165
	Deleting user-defined accounts	167
	Changing user account parameters	167
	Maintaining passwords	168
	User-defined roles	170
	Guidelines and restrictions	170
	Creating a user-defined role	171
	Editing a user-defined role	172
	Access control list policy configuration	173
	Virtual Fabrics considerations	174
	Creating an SCC, DCC, or FCS policy	174
	Editing an SCC, DCC, or FCS policy	174
	Deleting all SCC, DCC, or FCS policies	175
	Activating all SCC, DCC, or FCS policies	175
	Distributing an SCC, DCC, or FCS policy	175
	Moving an FCS policy switch position	176
	Configuring Advanced Device Security policy	176
	Fabric-Wide Consistency Policy configuration	177
	Authentication policy configuration	178
	Configuring authentication policies for E_Ports	178
	Configuring authentication policies for F_Ports	178
	Distributing authentication policies	179
	Re-authenticating policies	179
	Setting a shared secret key pair	179
	Modifying a shared secret key pair	180
	Setting the Switch Policy Authentication mode	180

SNMP configuration	180
Setting SNMP trap levels	180
Changing the systemGroup configuration parameters	181
Setting SNMPv1 configuration parameters	181
Setting SNMPv3 configuration parameters	181
Changing the access control configuration	182
RADIUS management	182
Enabling and disabling RADIUS	183
Configuring RADIUS	183
Modifying the RADIUS server	184
Modifying the RADIUS server order	185
Removing a RADIUS server	185
Active Directory service management	185
Enabling Active Directory service	185
Modifying Active Directory service	186
Removing Active Directory service	186
TACACS+ management	187
Enabling and disabling TACACS+	187
Configuring TACACS+	187
Modifying TACACS+	187
Removing TACACS+	188
IPsec concepts	188
Transport mode and tunnel mode	189
IPsec header options	190
Basic IPsec configurations	191
Internet Key Exchange concepts	192
IPsec over management ports	194
Enabling the Ethernet IPsec policies	194
Establishing an IKE policy	195
Creating a security association	195
Creating an SA proposal	196
Adding an IPsec transform policy	197
Adding an IPsec selector	197
Manually creating an SA	198
Editing an IKE or IPsec policy	199
Deleting an IKE or IPsec policy	199
Establishing authentication policies for HBAs	200

Chapter 16

Administering FICON CUP Fabrics

FICON CUP fabrics overview	201
Enabling port-based routing	202
Enabling or disabling FICON Management Server mode	203
FMS parameter configuration	203
Configuring FMS mode parameters	204
Displaying code page information	205
Viewing the control device state	205

Allow / Prohibit Matrix configuration	206
Viewing Allow / Prohibit Matrix configurations	207
Modifying Allow / Prohibit Matrix configurations	207
Activating an Allow / Prohibit Matrix configuration	209
Copying an Allow / Prohibit Matrix configuration	209
Deleting an Allow / Prohibit Matrix configuration	210
CUP logical path configuration	210
Viewing CUP logical path configurations	210
Configuring CUP logical paths	210
Link Incident Registered Recipient configuration	211
Viewing Link Incident Registered Recipient configurations ..	211
Configuring LIRRs	211
Displaying Request Node Identification Data	212

Chapter 17

Configuring FCoE with Web Tools

Web Tools and FCoE overview	213
Web Tools, the EGM license, and Brocade Network Advisor	214
Port information that is unique to FCoE	214
Switch administration and FCoE	215
FCOE configuration tasks	215
Quality of Service configuration	215
Editing the DCB map	216
Adding a traffic class map	216
LLDP-DCBX configuration	217
Configuring global LLDP characteristics	217
Adding an LLDP profile	219
Configuring DCB interfaces	220
Configuring a link aggregation group	221
Configuring VLANs	222
Configuring FCoE login groups	223
Displaying FCoE port information	223
Displaying LAG information	224
Displaying VLAN information	225
Displaying FCoE login groups	225
Displaying QoS information	225
Displaying LLDP-DCBX information	225
Displaying DCB interface statistics	225
Configuring a DCB interface from the Switch View	226
Configuring a DCB interface from the Port Admin panel	226
Enabling and disabling a LAG	226
Enabling and disabling LLDP	227

	Enabling and disabling QoS priority-based flow control	227
	Enabling and disabling FCoE ports	227
Chapter 18	Limitations	
	General Web Tools limitations	229
Index		

Figures

Figure 1	Configuring Internet Explorer	6
Figure 2	Default Java for browsers option	9
Figure 3	Web Tools interface.	11
Figure 4	Virtual Fabric login option	12
Figure 5	Switch Explorer	19
Figure 6	USB port storage management	22
Figure 7	Right-click menu for ports (from Switch Explorer).	25
Figure 8	Switch Administration window, Switch tab, Basic mode.	30
Figure 9	Blade tab	34
Figure 10	High Availability window, CP tab	46
Figure 11	Logical ports.	54
Figure 12	Information dialog box.	55
Figure 13	Fabric ID selector.	56
Figure 14	Port swapped label	75
Figure 15	Port swapping index	76
Figure 16	ALPA Map selection.	78
Figure 17	ALPA Map dialog	78
Figure 18	FC Explorer dialog	79
Figure 19	Port Octet Speed Combination dialog	79
Figure 20	Trunking tab.	86
Figure 21	Accessing performance graphs	93
Figure 22	Canvas of six performance monitoring graphs	94
Figure 23	Select Ports for customizing the Switch Throughput Utilization graph	96
Figure 24	Zone Administration window.	106
Figure 25	Port WWN icon for host	107
Figure 26	Port WWN icon for device	107
Figure 27	Sample zoning database.	115
Figure 28	Temperature Sensor States window	125
Figure 29	Fan States window.	126
Figure 30	Power States window	127
Figure 31	Switch Report window	128
Figure 32	Switch Status Policy dialog box.	129
Figure 33	Switch Explorer view for Access Gateway mode	140
Figure 34	Access Gateway Auto Rebalancing.	147
Figure 35	Extended Fabric tab.	153
Figure 36	Routing tab.	158

Figure 37	User tab	165
Figure 38	Add User Account dialog box (VF).....	166
Figure 39	Switch Admin:Add User Defined Role dialog.....	172
Figure 40	Switch Admin:Add User Defined Role dialog.....	173
Figure 41	Transport mode and tunnel mode comparison.....	190
Figure 42	AH header in transport mode and tunnel mode	190
Figure 43	ESP header in transport mode and tunnel mode	191
Figure 44	Edit Allow / Prohibit Matrix dialog box swapped label	207
Figure 45	Allow / Prohibit Matrix Configuration dialog box	209
Figure 46	Switch RNID information.....	212
Figure 47	Switch Administration DCB subtabs.....	215
Figure 48	FCoE Ports tab, Port Administration panel.....	224

Tables

Table 1	Basic Web Tools features and EGM licensed features	2
Table 2	Web Tools functionality moved to Brocade Network Advisor	3
Table 3	Certified and tested platforms.	4
Table 4	Supported platforms.	5
Table 5	Predefined Web Tools roles	13
Table 6	Polling rates	26
Table 7	Switches that support WWN-based Persistent PID on Web Tools.	40
Table 8	Event severity levels.	48
Table 9	Ports enabled with POD licenses and DPOD feature.	71
Table 10	Port octet speed combinations	78
Table 11	Basic performance graphs.	91
Table 12	Advanced performance monitoring graphs	91
Table 13	Supported port types for Brocade switches	91
Table 14	QoS zone name prefixes	104
Table 15	Long-distance settings and license requirements	153
Table 16	User role and permissions	164
Table 17	Relevant RFCs.	189
Table 18	Encryption algorithm options.	192
Table 19	Hash algorithm options	193
Table 20	FMS mode parameter descriptions.	204
Table 21	Web Tools limitations	229

About This Document

In this chapter

- [How this document is organized](#) xxi
- [Supported hardware and software](#)..... xxii
- [What's new in this document](#)..... xxiii
- [Document conventions](#) xxiv
- [Notice to the reader](#) xxv
- [Additional information](#)..... xxvi
- [Getting technical help](#)..... xxvi
- [Document feedback](#) xxvii

How this document is organized

This document is organized to help you find the information that you want as quickly and easily as possible.

The document contains the following components:

- [Chapter 1, “Introducing Web Tools”](#) provides some basic information about the Web Tools interface, including system requirements and installation instructions.
- [Chapter 2, “Using the Web Tools Interface”](#) describes the components of the Web Tools interface.
- [Chapter 3, “Managing Fabrics and Switches”](#) provides information on how to manage your fabric and switches using the Web Tools interface.
- [Chapter 4, “Maintaining Configurations and Firmware”](#) provides information about uploading and downloading configuration files and downloading firmware.
- [Chapter 5, “Managing Ports”](#) provides information about managing FC and GbE ports.
- [Chapter 6, “Enabling ISL Trunking”](#) provides information on managing the licensed ISL Trunking feature.
- [Chapter 7, “Monitoring Performance”](#) provides information on how to use the Brocade Advanced Performance Monitoring feature to monitor your fabric performance.
- [Chapter 8, “Administering Zoning”](#) provides information on how to use the Brocade Advanced Zoning feature to partition your storage area network (SAN) into logical groups of devices that can access each other.
- [Chapter 9, “Working with Diagnostic Features”](#) provides information about trace dumps, viewing switch health, and interpreting the LEDs.
- [Chapter 10, “Using the FC-FC Routing Service”](#) provides information on using the FC-FC Routing Service to share devices between fabrics without merging those fabrics.

- [Chapter 11, “Using the Access Gateway”](#) provides information on how to configure and manage the Brocade Access Gateway.
- [Chapter 12, “Administering Fabric Watch”](#) provides information on how to use the Fabric Watch feature to monitor the performance and status of switches and alert you when problems arise.
- [Chapter 13, “Administering Extended Fabrics”](#) provides information on how to configure a port for long distance.
- [Chapter 14, “Routing Traffic”](#) provides information on how to configure routes.
- [Chapter 15, “Configuring Standard Security Features”](#) provides information on managing user accounts, SNMP, and the RADIUS server.
- [Chapter 16, “Administering FICON CUP Fabrics”](#) provides information on how to administer and manage FICON CUP fabrics. You can enable FMS mode, edit and create configurations, and edit FMS parameters.
- [Chapter 17, “Configuring FCoE with Web Tools”](#) provides information on how to configure FCoE features.
- [Chapter 18, “Limitations”](#) discusses limitations of and provides workarounds for using Web Tools.

Supported hardware and software

In those instances in which procedures or parts of procedures documented here apply to some switches but not to others, this guide identifies exactly which switches are supported and which are not.

Although many different software and hardware configurations are tested and supported by Brocade Communications Systems, Inc. for Fabric OS v7.1.0, documenting all possible configurations and scenarios is beyond the scope of this document.

The following hardware platforms are supported by this release:

- Brocade 300
- Brocade 5100
- Brocade 5300
- Brocade 5410
- Brocade 5424
- Brocade 5450
- Brocade 5460
- Brocade 5470
- Brocade 5480
- Brocade NC-5480
- Brocade 6505
- Brocade 6510
- Brocade 6520
- Brocade 7800 Extension
- Brocade 8000

- Brocade DCX 8510-4
- Brocade DCX 8510-8 Backbone
- Brocade DCX Backbone
- Brocade DCX-4S Backbone
- Brocade Encryption Switch
- Brocade VA-40FC

The following blades are supported by this release:

- Brocade CORE 8 blade
- Brocade CP8 blade
- Brocade CR16-4 blade
- Brocade CR16-8 blade
- Brocade CR4S-8 blade
- Brocade FC16-32 port blade
- Brocade FC16-48 port blade
- Brocade FC8-16 port blade
- Brocade FC8-32 port blade
- Brocade FC8-32E port blade
- Brocade FC8-48 port blade
- Brocade FC8-48E port blade
- Brocade FC8-64 port blade
- Brocade FCOE10-24 blade
- Brocade FS8-18 Encryption blade
- Brocade FX8-24 Extension blade

What's new in this document

The following additions/enhancements have been made since this document was last released:

- Support for Brocade 6520
- Support for IE 9.0
- Tabbed view of the GUI
- Technical SupportSave logs
- Compression and Encryption for FC ports
- Different icons for node WWN and port WWN
- Rate of compression across ISL
- Port icon toggling
- Dynamic BB-credit allocation and management
- Switch persistent enable/disable
- GigE port modes

- Switching between virtual fabrics
- TACACS+ management
- Setting a principal switch
- Switch Status Policy changes
- Forward Error Correction
- Port Admin button grouping
- Updated 'Setting a shared secret key pair' section to include HBA
- Removed support for admin domain
- Addition of PCS block error to the Advanced tab of Port Statistics
- Drop of Interopmode 1: Open mode, Interopmode 2: McData Fabric mode, and Interopmode 3: McData Fabric legacy mode for Ex-Ports
- User configured table column alignment is retained during auto or manual refresh and while moving between the tabs
- Addition of a row to display Power on Time in SFP tab
- Support for Device Based Routing
- Addition of sub type to Fabric tree tool tip and XISL display enhancements.

For further information, refer to the release notes.

Document conventions

This section describes text formatting conventions and important notice formats used in this document.

Text formatting

The narrative-text formatting conventions that are used are:

bold text	Identifies command names Identifies the names of user-manipulated GUI elements Identifies keywords and operands Identifies text to enter at the GUI or CLI
<i>italic text</i>	Provides emphasis Identifies variables Identifies paths and Internet addresses Identifies document titles
<code>code text</code>	Identifies CLI output Identifies command syntax examples

For readability, command names in the narrative portions of this guide are presented in mixed lettercase: for example, **switchShow**. In actual examples, command lettercase is often all lowercase. Otherwise, this manual specifically notes those cases in which a command is case sensitive.

Notes, cautions, and warnings

The following notices and statements are used in this manual. They are listed below in order of increasing severity of potential hazards.

NOTE

A note provides a tip, guidance, or advice, emphasizes important information, or provides a reference to related information.

ATTENTION

An Attention statement indicates potential damage to hardware or data.



CAUTION

A Caution statement alerts you to situations that can be potentially hazardous to you or cause damage to hardware, firmware, software, or data.



DANGER

A Danger statement indicates conditions or situations that can be potentially lethal or extremely hazardous to you. Safety labels are also attached directly to products to warn of these conditions or situations.

Key terms

For definitions specific to Brocade and Fibre Channel, see the *Brocade Glossary*.

For definitions of SAN-specific terms, visit the Storage Networking Industry Association online dictionary at:

<http://www.snia.org/education/dictionary>

Notice to the reader

This document may contain references to the trademarks of the following corporations. These trademarks are the properties of their respective companies and corporations.

These references are made for informational purposes only.

Corporation	Referenced Trademarks and Products
Microsoft Corporation	Windows 7, Windows Server 2008 Standard, Windows Vista Business, Windows XP- SP3, Internet Explorer
Oracle Corporation	Oracle, Solaris
Red Hat, Inc.	Red Hat, Red Hat Network
Mozilla	Firefox

Additional information

This section lists additional Brocade and industry-specific documentation that you might find helpful.

Brocade resources

To get up-to-the-minute information, go to <http://my.brocade.com> to register at no cost for a user ID and password.

White papers, online demonstrations, and data sheets are available through the Brocade website at:

<http://www.brocade.com/products-solutions/products/index.page>

For additional Brocade documentation, visit the Brocade website:

<http://www.brocade.com>

Release notes are available on the MyBrocade website and are also bundled with the Fabric OS firmware.

Other industry resources

For additional resource information, visit the Technical Committee T11 website. This website provides interface standards for high-performance and mass storage applications for Fibre Channel, storage management, and other applications:

<http://www.t11.org>

For information about the Fibre Channel industry, visit the Fibre Channel Industry Association website:

<http://www.fibrechannel.org>

Getting technical help

Contact your switch support supplier for hardware, firmware, and software support, including product repairs and part ordering. To expedite your call, have the following information available:

1. General Information

- Switch model
- Switch operating system version
- Software name and software version, if applicable
- Error numbers and messages received
- **supportSave** command output
- Detailed description of the problem, including the switch or fabric behavior immediately following the problem, and specific questions
- Description of any troubleshooting steps already performed and the results

- Serial console and Telnet session logs
- syslog message logs

2. Switch Serial Number

The switch serial number and corresponding bar code are provided on the serial number label, as illustrated below:

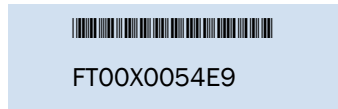

The serial number label is located as follows:

- *Brocade 300, 5100, 5200, 5300, 6505, 6510, 6520, 7800, 8000, VA-40FC, and Brocade Encryption Switch*—On the switch ID pull-out tab located inside the chassis on the port side on the left.
- *Brocade 5000*—On the switch ID pull-out tab located on the bottom of the port side of the switch.
- *Brocade DCX and 8510-8*—On the bottom right on the port side of the chassis.
- *Brocade DCX-4S and 8510-4*—On the bottom right on the port side of the chassis, directly above the cable management comb.
- *Brocade 8000*—On the switch ID pull-out tab located inside the chassis on the port side on the left.

3. World Wide Name (WWN)

Use the **licenseIdShow** command to display the WWN of the chassis.

If you cannot use the **licenseIdShow** command because the switch is inoperable, you can get the WWN from the same place as the serial number, except for the Brocade DCX. For the Brocade DCX, access the numbers on the WWN cards by removing the Brocade logo plate at the top of the nonport side of the chassis.

Document feedback

Quality is our first concern at Brocade and we have made every effort to ensure the accuracy and completeness of this document. However, if you find an error or an omission, or you think that a topic needs further development, we want to hear from you. Forward your feedback to:

documentation@brocade.com

Provide the title and version number of the document and as much detail as possible about your comment, including the topic heading and page number and your suggestions for improvement.

Introducing Web Tools

In this chapter

• Web Tools overview	1
• Web Tools, the EGM license, and Brocade Network Advisor	1
• System requirements	4
• Java installation on the workstation.....	7
• Java plug-in configuration	8
• Value line licenses	9
• Opening Web Tools	10
• Role-Based Access Control	13
• Session management	14
• Web Tools system logs	15
• Requirements for IPv6 support	16

Web Tools overview

Brocade Web Tools is an embedded graphical user interface (GUI) that enables administrators to monitor and manage single or small fabrics, switches, and ports. Web Tools is launched directly from a web browser, or from the Brocade Network Advisor.

A limited set of features is accessible using Web Tools without a license, and is available free of charge. Additional switch management features are accessible using Web Tools with the Enhanced Group Management (EGM) license. Refer to [“Web Tools, the EGM license, and Brocade Network Advisor”](#) for more information.

Web Tools, the EGM license, and Brocade Network Advisor

Beginning with Fabric OS version 6.1.1, Web Tools functionality is tiered and integrated with Brocade Network Advisor. If you are migrating from a Web Tools release prior to Fabric OS version 6.1.1, this may impact how you use Web Tools.

A Web Tools license is not required, and a basic version of Web Tools is available for free. Additional functionality may be added by obtaining the Enhanced Group Management (EGM) license. [Table 1](#) compares Basic Web Tools features to Web Tools with the EGM license. The EGM license is only for 8 Gbps platforms, such as the Encryption Switch, and the 300, 5100, and 5300 switches. For non-8 Gbps platforms, all functionalities are available without the EGM license.

Beginning with Fabric OS version 6.1.1, some Web Tools capabilities are moved from Web Tools to Brocade Network Advisor. [Table 2](#) summarizes these changes.

Web Tools features enabled by the EGM license

Table 1 describes those Web Tools features that require the EGM license.

TABLE 1 Basic Web Tools features and EGM licensed features

Feature	Basic Web Tools	Web Tools with EGM License
Active Directory support	yes	yes
AG Management	yes	yes
Analyze zone config	no	no
Basic Zoning and TI Zoning	yes	yes
Blade Management	yes	yes
Cloning a zone	no	yes
Configuration upload/download	yes	yes
Convenience function from Tools menu	no	no
Device Accessibility Matrix	no	no
Easy to configure iSCSI wizard	yes	yes
Extended Fabric Management	no	yes
F_Port Trunk Management	no	yes
Fabric Events	no	no
Fabric Summary	no	no
Fabric Tree	yes	yes
FCIP Tunnel configuration	no	no
FCIP Tunnel Display	yes	yes
FCR Management	yes	yes
FCR Port Config	yes	yes
FICON CUP Tab	no	yes
FRU Monitoring	yes	yes
High Availability	yes	yes
IP Sec Policies	yes	yes
ISL Trunk Management	no	yes
ISL Trunking information	yes	yes
License Management	yes	yes
Long Distance	no	yes
Logical Switch Context Switching	no	yes
Allow/Prohibit Matrix	no	yes
Performance Monitoring Dialog	no	yes
Port Administration	yes	yes
Print zone database summary	no	no
RBAC	yes	yes

TABLE 1 Basic Web Tools features and EGM licensed features (Continued)

Feature	Basic Web Tools	Web Tools with EGM License
Routing and DLS Configuration	no	yes
Security Policies Tab (like ACL)	yes	yes
Switch Info tab	yes	yes
Switch Status	yes	yes
Switch View right-click options	yes	yes
Trace dump	yes	yes
USB Management	yes	yes
User Management	yes	yes
Verify and troubleshoot accessibility between devices	yes	yes

Web Tools functionality moved to Brocade Network Advisor

The functionality that was moved from Web Tools into Brocade Network Advisor is detailed in [Table 2](#).

TABLE 2 Web Tools functionality moved to Brocade Network Advisor

Function	Web Tools 6.1.0	Brocade Network Advisor	Comments
Add Un-Zoned Devices	Zone Admin	Configure > Zoning Reverse Find in the Zoning dialog box provides the view of the zoned and unzoned devices in the fabric if all zone members are selected for Find.	
Analyze Zone Config	Zone Admin	1 Configure > Zoning: Reverse Find in the Zoning dialog box provides the view of the zoned and unzoned devices in the fabric if all zone members are selected for Find. 2 Device Tree and Topology: Connected End Devices – Custom Display from the top level in the main frame provides the device tree and topology view for all the zoned devices if all zones are selected in the active zone configuration.	
Define Device Alias	Zone Admin	Configure > Zoning	
Device Accessibility Matrix	Zone Admin	Configure > Zoning the Compare dialog box provides the Storage-Host and Host-Storage view in a tree representation that is comparable to the Device Accessibility Matrix when all devices are selected.	
Fabric Events	Monitor > Fabric Events	Monitor > Logs > Events	
Fabric Summary	Reports > Fabric Summary	Monitor > Reports > Fabric Summary Report	

1 System requirements

TABLE 2 Web Tools functionality moved to Brocade Network Advisor (Continued)

Function	Web Tools 6.1.0	Brocade Network Advisor	Comments
FCIP Tunnel Configuration	Port Admin Module > GigE tab	Configure > FCIP Tunnel	Viewing FCIP tunnels is still supported in Web Tools 6.1.1, but New, Edit Config, and delete are only available in Brocade Network Advisor.
GigE Ports Interface	Port Admin Module > GigE tab	Configure > FCIP Tunnel	
GigE Ports Route	Port Admin Module > GigE tab	Configure > FCIP Tunnel	
Non-local switch ports display in zoning tree	Zone Admin Switch Admin > DCC policies Performance Monitoring	Configure > Zoning	In Web Tools, non-local switch port id/WWN can be added using text box.
Remove Offline or Inaccessible Devices	Zone Admin	Configure > Zoning Replace/Replace All zone members by selecting the offline devices from the zone tree. Offline devices have an unknown overlay badge with good visibility.	
Zone database summary print	Zone Admin	Configure > Zoning Zoning report for both online and offline database.	

System requirements

Before you install Web Tools on your workstation, verify that your switches and workstation meet the Web Tools requirements listed in this chapter.

Web Tools requires any browser that conforms to HTML version 4.0, JavaScript version 1.0, and Java Plug-in 1.7.0_09 or later.

Brocade has certified and tested Web Tools on the platforms shown in [Table 3](#).

TABLE 3 Certified and tested platforms

Operating System	Browser
Windows Server 2008 R2 Standard (64-bit)	Internet Explorer 8.0/9.0
Windows Server 2008 Standard	Firefox 12.0, Internet Explorer 8.0/9.0
Windows 7 Service Pack 1 (SP1)	Firefox 12.0, Internet Explorer 8.0/9.0
Red Hat Enterprise Server 5 Advanced Platform	Firefox 12.0
SUSE Linux Enterprise Server 10	Firefox 12.0

Brocade supports the platforms shown in [Table 4](#).

TABLE 4 Supported platforms

Operating System	Browser
Red Hat AS 4.0 (x86 32-bit)	Firefox 12.0
RedHat Enterprise Linux 6.1 Adv (32-bit)	
SUSE Linux Enterprise Server 10 (32-bit)	
SUSE Linux Enterprise Server 11 (x86 32-bit)	
Windows 2000	Firefox 12.0, Internet Explorer 9.0
Windows 2003 Server, SP2	Firefox 12.0, Internet Explorer 8.0/9.0
Windows XP Pro SP3 (x86 32-bit)	Firefox 12.0, Internet Explorer 8.0/9.0
Windows Server 2003 Standard SP2 (x86 32-bit)	Firefox 12.0, Internet Explorer 8.0/9.0
Windows Server 2008 Standard	Firefox 12.0, Internet Explorer 8.0/9.0
Windows 7 Service Pack 1 (SP1)	Firefox 12.0, Internet Explorer 8.0/9.0
Solaris 9 (SPARC only)	Firefox 12.0
Solaris 10 (SPARC only)	
Oracle Enterprise Linux 6.1 (x86 32-bit)	Firefox 12.0

For Windows systems, a minimum of 256 MB of RAM for fabrics comprising up to 15 switches, 512 MB of RAM for fabrics comprising more than 15 switches, and a minimum of 8 MB of video RAM are recommended. Additionally, a DCX with a fully populated FC8-64 blade requires a minimum of 512 MB of RAM.

Setting refresh frequency for Internet Explorer

Correct operation of Web Tools with Internet Explorer requires specifying the appropriate settings for browser refresh frequency and process model. Browser pages should be refreshed frequently to ensure the correct operation of Web Tools.

To set the Internet Explorer options, perform the following steps.

1. Open your web browser and select **Tools > Internet Options**.
2. Select **General > Browsing History > Settings**.
3. Choose **Every time I visit the webpage** under “Check for newer versions of stored pages:” as shown in [Figure 1](#) on page 6.

1 System requirements

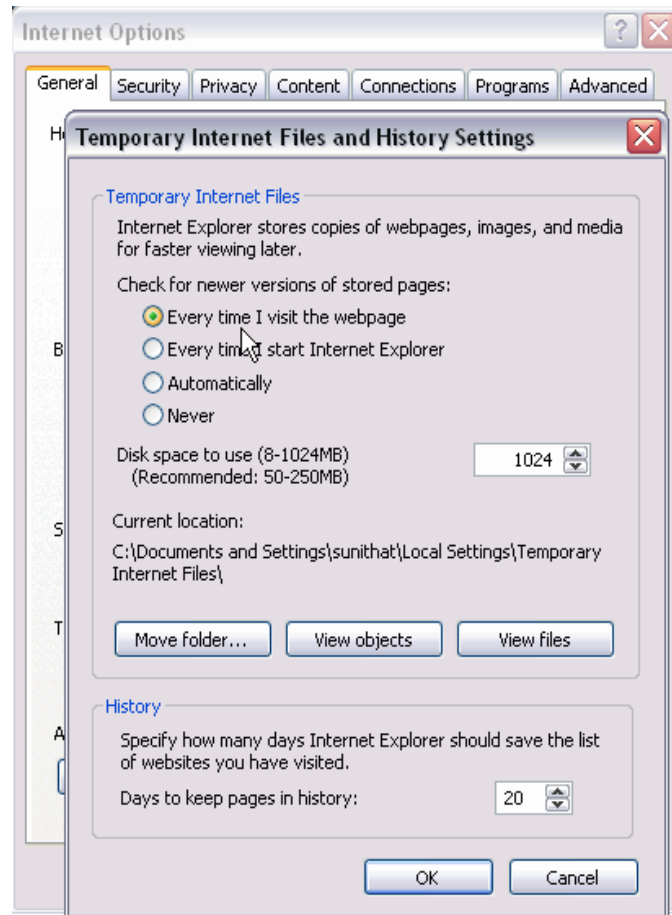

FIGURE 1 Configuring Internet Explorer

Deleting temporary internet files used by Java applications

For Web Tools to operate correctly, you must delete the temporary internet files used by Java applications.

To delete these files, perform the following steps.

1. From the **Control Panel**, open Java.
2. Select the **General** tab and click **Settings**.
3. Click **Delete Files** to remove the temporary files used by Java applications.
4. Click **OK** on the confirmation dialog box.

You can clear the **Trace and Log files** check box if you want to keep those files.

5. Click **OK**.
6. On the **Java Control Panel**, click **View** to review the files that are in the Java cache.

If you have deleted all the temporary files, the list is empty.

Java installation on the workstation

Java Plug-in must be installed on the workstation. If you attempt to open Web Tools without any Java Plug-in installed:

- Internet Explorer automatically prompts and downloads the proper Java Plug-in.
- Firefox downloads the most recently released Java Plug-in.

If you attempt to open Web Tools with a later version of Java Plug-in installed:

- Internet Explorer might prompt for an upgrade, depending on the existing Java Plug-in version.
- Firefox uses the existing Java Plug-in.

Installing the JRE on your Solaris or Linux client workstation

To install JRE on your Solaris or Linux client workstation, perform the following steps.

1. Locate the JRE on the Internet, at the following URL:

<http://www.oracle.com/technetwork/java/archive-139210.html>

NOTE

This URL points to a non-Brocade website and is subject to change without notice.

2. On locating the JRE link, follow the instructions to install the JRE.

3. Create a symbolic link from this location:

`$FIREFOX/plugins/libjavaplugin_oji.so`

To this location:

`$JRE/plugin/$ARCH/ns600/libjavaplugin_oji.so`

Installing patches on Solaris

To install patches on Solaris, perform the following steps.

1. Search for any required patches for your current version of the JRE at the following website:

<http://www.oracle.com/technetwork/java/javase/downloads/jre7u9-downloads-1859586.html>

NOTE

This URL points to a non-Brocade website and is subject to change without notice.

2. Follow the link to download the patch.
3. Exit the browser when you have downloaded the patch.
4. Install the patch and restart the system.

Installing the Java plug-in on Windows

To Install the Java plug-in on Windows, perform the following steps.

1. From the **Start** menu, select **Control Panel** and select the Java Plug-in Control Panel.
2. Select the **About** tab.
3. Determine whether the correct Java Plug-in version is installed:
 - If the correct version is installed, Web Tools is ready to use.
 - If no Java Plug-in is installed, point the browser to a switch running Fabric OS 5.2.0 or later to install JRE 1.6.0. For Fabric OS 6.3.0 install JRE 1.6.0 update 13. Web Tools guides you through the steps to download the proper Java Plug-in.
 - If an outdated version is currently installed, uninstall it, restart your computer, reopen the browser, and enter the address of a switch running Fabric OS 5.2.0 or later to install JRE 1.6.0. For Fabric OS 6.3.0 install JRE 1.6.0 update 13. Web Tools guides you through the steps to download the proper Java Plug-in.

Java plug-in configuration

If you are managing fabrics with more than 10 switches or 1000 ports, or if you are using the iSCSI Gateway module extensively, you should increase the default heap size to 256 MB to avoid out-of-memory errors.

If you are using a Mozilla family browser (Firefox, Netscape), you should set the default browser in the Java control panel.

The following procedures instruct you in increasing the default heap size in the **Java Control Panel** and in setting the default browser.

Configuring the Java plug-in for Windows

To configure Java plug-in for Windows, perform the following steps.

1. From the **Start** menu, select **Control Panel > Java**.
2. Click the **Java** tab.
3. In the section **Java Applet Runtime Settings**, click **View**.

The **Java Runtime Environment Settings** dialog box displays.

4. Double-click the **Runtime Parameters** field and enter the following information to set the minimum and maximum heap size:

```
-Xms256m -Xmx256m
```

In this example, the minimum and maximum sizes are both 256 MB.

5. Click **Ok** to apply your settings and close the Java Control Panel.

Configuring the Java Plug-in for Mozilla family browsers

To configure Java Plug-in for Mozilla family browsers, perform the following steps.

1. From the **Start** menu, select **Control Panel**.
2. Click the **Advanced** tab and expand the **Default Java for browsers** option, as shown in [Figure 2](#) on page 9.

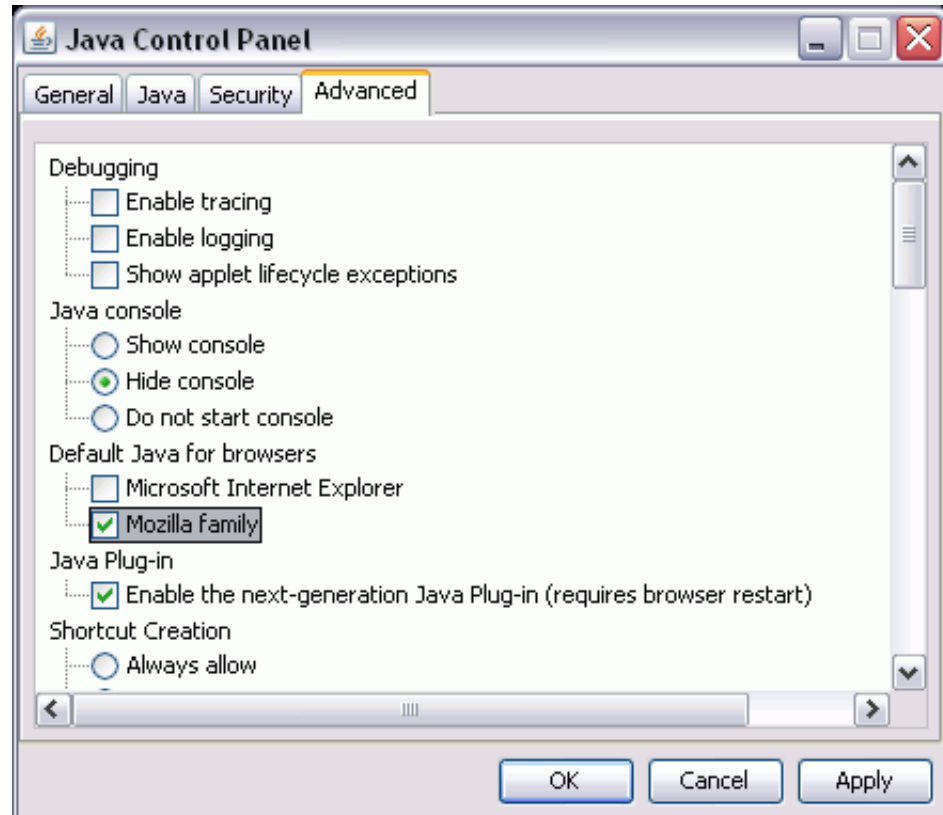

FIGURE 2 Default Java for browsers option

3. Select **Mozilla family** and click **Apply**.
4. Click **OK** to apply your settings and close the Java Control Panel.

Value line licenses

If you open Web Tools on a switch with a limited license, and if the fabric exceeds the switch limit indicated in the license, then Web Tools displays a warning message. Web Tools allows a 30-day grace period, during which you can still monitor the switch while continuing to display warning messages periodically.

These messages warn you that your fabric size exceeds the supported switch configuration limit and tells you how long you have before Web Tools is disabled. After the 30-day grace period, you are no longer able to open Web Tools from the switch with the limited switch license.

Web Tools is part of the Fabric OS of a switch. When you open Web Tools on a switch, you can manage other switches in the fabric that have lower or higher firmware versions. It is important to note that when accessing these switches you are opening the remote switch's version of Web Tools, and the functionality available for those switches might vary.

Opening Web Tools

You can open Web Tools on any workstation with a compatible Web browser installed. For a list of Web browsers compatible with Fabric OS v7.1.0, refer to [Table 3](#). Web Tools supports both HTTP and HTTPS protocol.

To open Web Tools, perform the following steps.

1. Open the Web browser and enter the IP address of the device in the **Address** field, such as:

```
http://10.77.77.77
```

or

```
https://10.77.77.77
```

2. Press **Enter**.

The Web Tools login dialog box displays. Refer to [“Logging in”](#) on page 11 for more information.

NOTE

If you are using Firefox, the browser window is left open. You can close it anytime after the login dialog box displays. If you are using Internet Explorer, the browser window automatically closes when the login dialog box displays.

NOTE

If you have installed EZSwitchSetup on your workstation, the EZSwitchSetup Switch Manager displays the first time you access the device. EZSwitchSetup provides an easy to use wizard interface that may be used to simplify the initial setup procedure for smaller switches. Refer to *EZSwitchSetup Administrator's Guide* for information about the EZSwitchSetup interface.

If you want to use Web Tools instead of EZSwitchSetup, click **Advanced Management** in the lower-left corner of the window to open the Web Tools interface. This book describes only the Web Tools interface.

10.24.33.28 - sw0 - Web Tools

Manage View Configure Monitor Reports Tools

Status Temp Power Fan Auto Refresh Interval 60 seconds Refresh Now

Switch View Port Admin Name Server

Fabric Tree

View by: Name

Fabric

- SW_5100.13
 - sw0
- Segmented Switches

Switch View

Switch Events, Information

Switch Events Switch Information

All Events Last Updated: 5:52:56 PM (Auto-Refresh interval is 15 seconds)

Time	Level	Message
Sun Aug 26 2012 23:10:59 GMT+00:00	Info	Processor rebooted - FirmwareDownload.
Sun Aug 26 2012 23:11:43 GMT+00:00	Info	HA State is in sync.
Sun Aug 26 2012 23:11:45 GMT+00:00	Warning	HA State out of sync.
Sun Aug 26 2012 23:12:00 GMT+00:00	Info	Firmwarecommit has started.
Sun Aug 26 2012 23:12:10 GMT+00:00	Warning	Fan/PS unit 2 not supplying power, fan speeds may not be available. Please ensure that the unit
Sun Aug 26 2012 23:12:28 GMT+00:00	Warning	Env Power Supply 2, is below low boundary(High=0, Low=1). Current value is 0 (1 OK/0 FAULT
Sun Aug 26 2012 23:15:25 GMT+00:00	Info	Firmwarecommit has completed.
Sun Aug 26 2012 23:15:25 GMT+00:00	Info	The new Version: Fabric OS v7.1.0_main_bld13
Sun Aug 26 2012 23:15:25 GMT+00:00	Info	Firmwaredownload command has completed successfully.
Mon Sep 03 2012 22:33:46 GMT+00:00	Info	Login information: Login successful via TELNET/SSH/RSH. IP Addr: 172.26.3.151
Mon Sep 03 2012 22:36:11 GMT+00:00	Warning	Attempt to change the base switch to switch 2 failed. Error message: xISL use is enabled on th
Mon Sep 03 2012 22:36:39 GMT+00:00	Warning	Attempt to change the base switch to switch 2 failed. Error message: xISL use is enabled on th
Mon Sep 03 2012 22:37:46 GMT+00:00	Info	Attempt to change the base switch to switch 2 succeeded
Mon Sep 03 2012 22:38:38 GMT+00:00	Warning	Logical port 40 disabled with reason 123(Domain ID overlap)
Sat Sep 08 2012 22:51:13 GMT+00:00	Info	Security violation: Login failure attempt via HTTP. IP Addr: 10.24.32.137
Sat Sep 08 2012 22:51:13 GMT+00:00	Info	Security violation: Login failure attempt via HTTP. IP Addr: 10.24.32.137
Mon Sep 10 2012 03:09:03 GMT+00:00	Info	Login information: Login successful via TELNET/SSH/RSH. IP Addr: 172.26.3.151
Mon Sep 10 2012 03:16:17 GMT+00:00	Warning	port 26, Zone Conflict.
Mon Sep 10 2012 03:23:47 GMT+00:00	Warning	demux_ipc_fmnode_set: licenseCheck FICON-CUP License Not Installed: (0).
Tue Sep 11 2012 20:55:05 GMT+00:00	Warning	port 26, domain IDs overlap.

Number of switches: 2

Getting events from switch...done

Switch View Refreshed : 5:52:32 PM

[Free Professional Management Tool](#) 10.24.33.28 | FID 128 - sw0 | User: admin | Role: admin

FIGURE 3 Web Tools interface

Logging in

When you use Web Tools, you must log in before you can view or modify any switch information. This section describes the login process.

Prior to displaying the login window, Web Tools displays a security banner (if one is configured for your switch), that you must accept before logging in. The security banner displays every time you access the switch.

When you are presented with the login screen you must provide a user name and a password.

NOTE

You must login before you can view Switch Explorer (shown in [Figure 3](#) on page 11).

Use this procedure to log in to the Admin Domain.

1 Opening Web Tools

1. Click **Run** on the signed certificate applet.

A warning dialog box may display. If you select the check box **Always trust content from this publisher**, the warning dialog box is not displayed when you open Web Tools again.

2. Click **OK** in the security banner window, if one displays.
3. In the login dialog box, enter your user name and password.

If your current password has expired, you must provide a new password and confirm the new password.

Logging in to a Virtual Fabric

If you are logging in to a platform that is capable of supporting Virtual Fabrics, the login dialog box provides the option of logging in to a virtual fabric. The following platforms support virtual fabrics:

- Brocade DCX and DCX-4S
- Brocade VA-40FC
- Brocade 6510
- Brocade 6520
- Brocade DCX 8510-8 and DCX 8510-4
- Brocade 5300
- Brocade 5100

To log in to a Virtual Fabric, perform the following steps.

1. Select **Options** to display the Virtual Fabric options.

You are given a choice between **Home Logical Fabric** and **User Specified Logical Fabric** (Figure 4). **Home Logical Fabric** is the default.

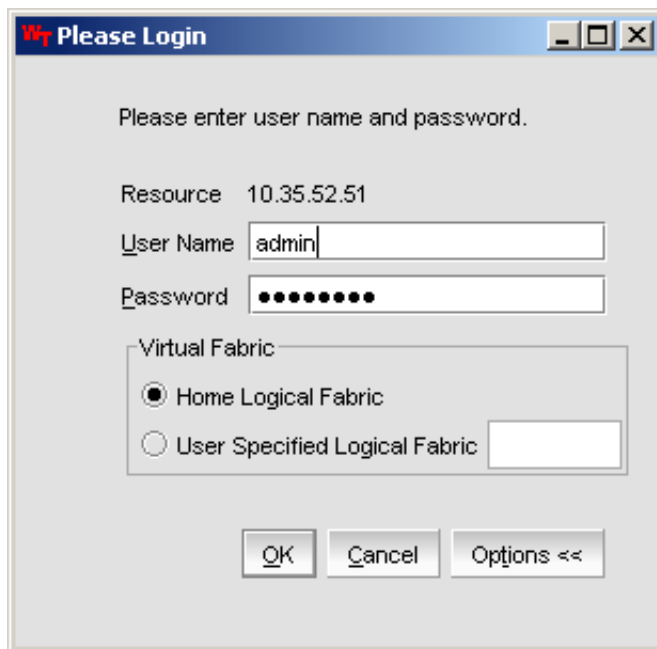

FIGURE 4 Virtual Fabric login option

2. Log in to a logical fabric.
 - To log in to the home logical fabric, select **Home Logical Fabric** and click **OK**.
 - To log in to a logical fabric other than the home logical fabric, select **User Specified Logical Fabric**, enter the fabric ID number or the context name, and click **OK**.

On providing the context name, a dialog box displays with the available list of VF ID-Context Name (role of the context). You can select the role from the list and login.

Switching between virtual fabrics

To switch between one virtual fabric to another, perform the following steps:

1. Login to Web Tools using the **User Specified Logical Fabric** option.
You can enter the context name to login.
2. Select the context name from the **Logical Switch** drop-down list, you want to access.
The base switch has **Base** appended in the context name.
3. Click **Yes** on the **Switch Virtual Fabric Context** confirmation dialog box.
4. Repeat steps 2 and 3 to switch to another virtual fabric.

Logging out

You can end a Web Tools session either by selecting **Manage > Exit**, or by closing the **Switch Explorer** window.

You might be logged out of a session involuntarily, without explicitly selecting the **Manage > Exit**, under the following conditions:

- You initiate a firmware download from Web Tool's **Switch Administration** window. In this case, you are logged out a few minutes later when the switch restarts.
- Your session times out.

Role-Based Access Control

Role-Based Access Control (RBAC) defines the capabilities that a user account has based on the assigned role. For each role, there is a set of predefined permissions on the jobs and tasks that can be performed on a fabric and its associated fabric elements.

When you log in to a switch, your user account is associated with a predefined role. The role determines the level of access you have on that switch and in the fabric. [Table 5](#) describes these roles.

For information about creating unique user account roles, refer to [“User-defined accounts”](#) on page 163.

TABLE 5 Predefined Web Tools roles

Role	Description
admin	You have full access to all of the Web Tools features.
operator	You can perform any actions on the switch that do not affect the stored configuration.

1 Session management

TABLE 5 Predefined Web Tools roles (Continued)

Role	Description
securityadmin	You can perform actions that do not affect the stored configuration.
switchadmin	You can perform all actions on the switch, except the following: <ul style="list-style-type: none">• You cannot modify zoning configurations.• You cannot create new accounts.• You cannot view or change account information for any accounts. You can only view your own account and change your account password.
zoneadmin	You can only create and modify zones.
fabricadmin	You can do everything the Admin role can do except create new users.
basicswitchadmin	You have a subset of Admin level access.
user	You have nonadministrative access and can perform tasks such as monitoring system activity.

Session management

A Web Tools session is the connection between the Web Tools client and its managed switch. A session is established when you log in to a switch through Web Tools. When you close Switch Explorer, Web Tools ends the session.

A session remains in effect until one of the following happens:

- You exit
- You close the **Switch Explorer** window
- The session ends due to inactivity (time out)

A session automatically ends if no information was sent to the switch for more than two hours. Because user key strokes are not sent to the switch until you apply or save the information, it is possible for your session to end while you are entering information in the interface. For example, entering a zoning scheme in the Zoning module does not require you to send information to the switch until you save the scheme.

Web Tools does not display a warning when the session is about to time out. If your session ends due to inactivity, all Web Tools windows become invalid and you must restart Web Tools and log in again.

Web Tools enables sessions to both secure and nonsecure switches.

Access rights for your session are determined by your role-based access rights. You cannot change your role-based permissions.

Ending a Web Tools session

To end a Web Tools session, perform one of the following actions:

- Select **Manage > Exit**.
- Click the X in the upper-right corner of the **Switch Explorer** window to close it.
- Close all open Web Tools windows.

Web Tools system logs

Web Tools uses the log4j framework to write the logs into a file

When you launch Web Tools for the first time, it automatically creates the following directories. These directories are created under Web Tools directory if they are not available:

- A <Web Tools> directory under the user home directory.
- The Web Tools Switch Support Save directory with the name format <Core Switch Name-Switch IP Address-Switch WWN>.

The Web Tools Switch Support Save directory contains the following files:

- Log4j.xml
- WebTools.log
- SwitchInfo.txt

The SwitchInfo.txt file contains the following basic switch information:

- Switch Name
- Fabric OS version
- Switch Type
- Ethernet IPv4
- Ethernet IPv4 subnet mask
- Ethernet IPv4 gateway

The maximum size of the webtools.log file is 2MB. It is rolled into new file when the 5MB file size limit is exceeded. A backup file named webtools1.log is automatically created. Web Tools maintains only one webtools.log backup file at a time.

The Web Tools debug dialog box can be used to enable the debug state and level for a module at runtime.

If you are familiar with XML scripting, you can edit the configuration file (log4j.xml) to collect the data at startup. If you edit the configuration file, Web Tools need to be restarted. Contact your switch support supplier for assistance.

Technical SupportSave logs

From v7.1.0, WebTools allows you to log information of the switch at any given point of time. SupportSave is a dump of the switch status that collects the following details of the switch:

- HTML files
- CAL files
- WebTools logs folder

To collect SupportSave logs, perform the following steps:

1. Click **Tools > Technical SupportSave**.

The **Technical SupportSave** dialog box displays.

2. Click **Browse** to select the location where the SupportSave output must be saved.

1 Requirements for IPv6 support

The default path for Windows is *C:\Documents and Settings\<<user>>\Webtools\<log file>*.

The default path for Linux is */root/WebTools/<switch log file>*.

3. Click **Capture** to start collecting the SupportSave logs.

A zipped-up SupportSave folder is saved in the defined location. SupportSave zip file name format is "WT-SS-switchIP-dd-mm-yy-hh-mm-ss.zip". The SupportSave file name will show the VF ID if VF is enabled on the switch.

NOTE

SupportSave collection is terminated if the time exceeds 20 minutes.

Requirements for IPv6 support

The following list provides requirements for Web Tools IPv6 support:

- In a pure IPv6 environment, you must configure your DNS maps to the IPv6 address of the switch.
- The switch name is required to match the DNS name that is mapped to the IPv6 address.
- If both IPv4 and IPv6 addresses are configured, Web Tools can be launched using any configured IP address.
- Use a switch with v5.3.0 or later firmware to manage a mixed fabric of IPv4 and IPv6 switches.
- Switches running on v5.2.0 do not discover IPv6 address-only switches in the same fabric until the IPv4 address is configured.

Using the Web Tools Interface

In this chapter

- Viewing Switch Explorer 17
- Displaying tool tips..... 24
- Right-click options 25
- Refresh rates 25
- Displaying switches in the fabric 26
- Working with Web Tools: recommendations 26
- Opening a Telnet or SSH client window 27
- Collecting logs for troubleshooting..... 28

Viewing Switch Explorer

The first thing you see when you log in to a switch with Web Tools is **Switch Explorer**, shown in [Figure 5](#) on page 19. **Switch Explorer** is divided into tabs and areas that provide access to, and information about the switch and fabric. The **Switch Explorer** areas are:

- Three tabs - **Switch View**, **Port Admin**, and **Name Server**.
If Access Gateway is enabled, **Access Gateway Devices** tab displays instead of **Name Server**. For more information, refer to [Chapter 11, “Using the Access Gateway”](#).
The **Fabric Tree** under **Switch View** displays a list of all the switches in the fabric.
- The menu bar, at the top of the window, provides access to the following tasks:
 - Viewing tasks, such as the switch view, port administration, and name server.
 - Configuration tasks, such as switch administration, zone administration, fabric watch, and switch status policy.

NOTE

You can manage basic zoning and Traffic Isolation zoning using Web Tools and Web Tools with the Enhanced Group Management (EGM) license. To perform clone operations for zoning, the EGM license must be installed on the switch; otherwise, access to this feature is denied and an error message displays.

You must use Brocade Network Advisor to print the zone database summary configuration and to analyze zone configurations. For more information on zoning management, refer to [“Zone configuration and zoning database management”](#) on page 115.

- Monitoring tasks, such as performance monitoring, system monitoring, and viewing the power, temperature, or fan status.

NOTE

To perform monitoring tasks such as performance monitoring the EGM license must be installed on the switch; otherwise, access to this feature is denied and an error message displays.

- Reporting tasks, such as viewing the status of a switch.
- Tools tasks, such as opening the Telnet or SSH client window, beaconing a switch or chassis, and access to technical SupportSave.
- The buttons below the menu bar provide access to switch information: status, temperature, power, and fan data.

Although clicking a button can open a separate dialog box or window displays the management tasks, all access control is established when you first log in to the switch.

Buttons in **Switch Explorer** are unavailable because your account does not have sufficient privileges to access this feature.

- The **Switch View** displays an interactive graphic of the switch.
- The **Switch Events** and **Switch Information** tabs allow you to view event information and switch information, including connectivity, port, zone and other information.
- The small right arrow near the **Switch Event** tab displays the switch. When you exit Web Tools, it remembers the last window settings the next time you log in to the application. If you display the switch, the next time you log in to Web Tools, by default the **Switch View** displays.

The EGM license is required only for 8 Gbps platforms, such as the following:

- Brocade Encryption Switch
- Brocade 300, 5300, and 5100 switches
- Brocade VA-40FC
- Brocade 8000
- Brocade 7800

For non-8 Gbps platforms, all functionalities are available without EGM license.

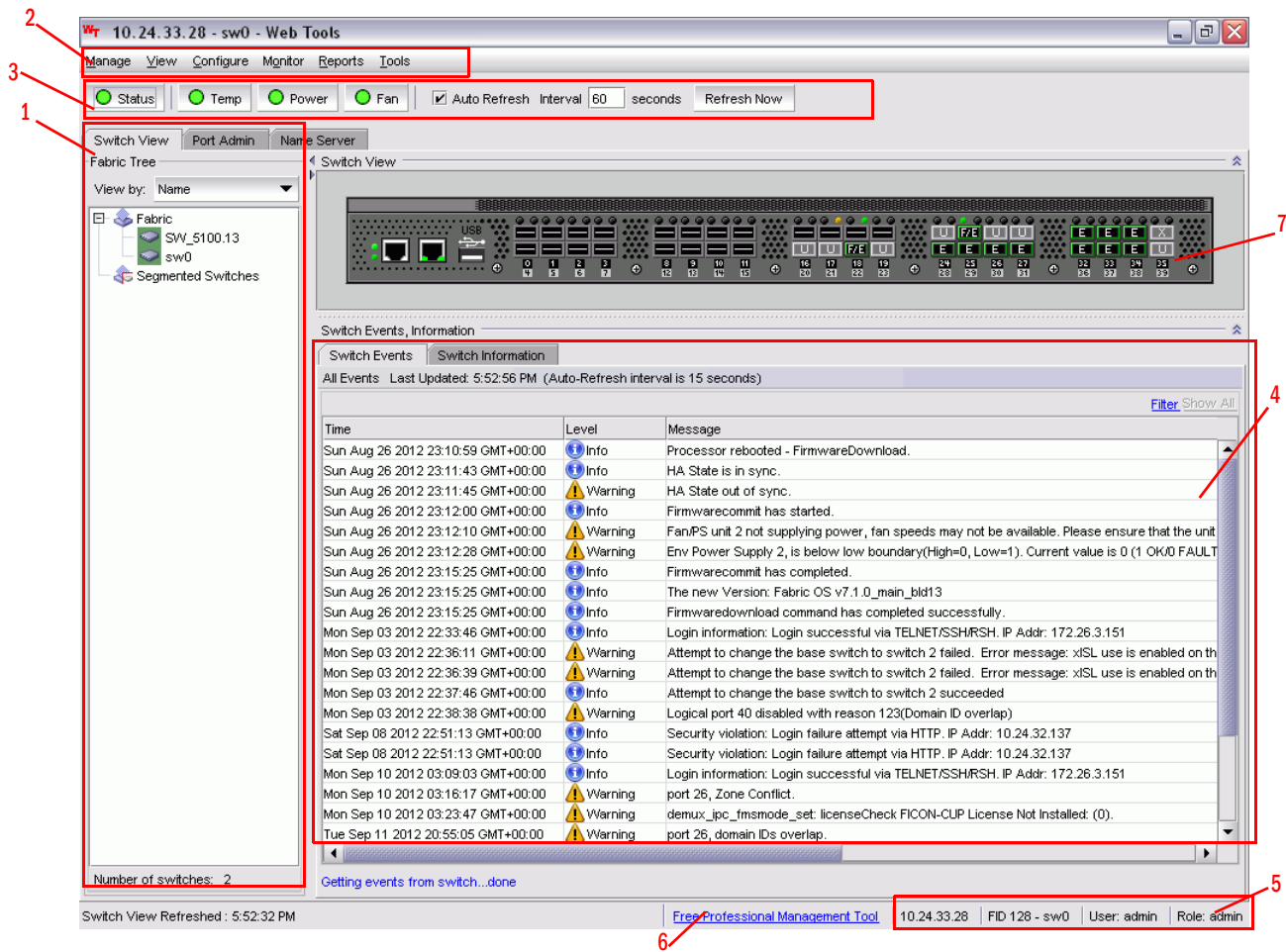

- 1 Tabs and **Fabric Tree**
- 2 Menu bar
- 3 **Switch View** buttons
- 4 Switch Events and Switch Information
- 5 Indicator bar
- 6 Professional Management Tool offering
- 7 Switch View

FIGURE 5 Switch Explorer

Persisting GUI preferences

Web Tools persists your GUI preferences across sessions for the **Switch Explorer**, **Port Admin**, **Switch Admin**, **Name Server**, and **Zone Admin** dialog boxes on all web-browser platforms. Persistence is performed on a per host basis.

If you launch WebTools from Brocade Network Advisor (BNA), all of the Web Tools GUI persistence data for each user name is stored in the BNA database.

The **Port Admin** GUI preferences that persist are:

2 Viewing Switch Explorer

- Basic or Advance mode
- Last selected tab by the user
- Table column sorting
- Table column positions

The **Switch Admin** GUI preferences that persist are:

- Basic or Advance modes
- Last selected tab
- Table column sorting
- Table column positions

The Switch Explorer GUI preferences that persists are:

- Last selected tab

The **Name Server** GUI preferences that persist are:

- Table column sorting
- Table column positions

The **Zone Admin** GUI preferences that persist are:

- Basic Zones
- Traffic Isolation Zones
- Last selected tab
- Table column sorting
- Table column positions

Tabs

The Switch Explorer provides access to the following three tabs:

- **Switch View**
- **Port Admin**
- **Name Server**—This feature is available with Web Tools and Web Tools with the EGM license. Name Server information is collected from the selected switch. Refer to [“Displaying the Name Server entries”](#) on page 50 for more information.

Fabric Tree

Fabric Tree under **Switch View** displays all switches in the fabric, even those that do not have a Web Tools license. **Fabric Tree** does not display switches segmented before you opened Web Tools.

Only two types of switch icons display in **Fabric Tree**; one for a pizza box and one for a chassis. No platform based icons are supported.

Use the drop-down menu at the top of the **Fabric Tree** area to view switches in the **Fabric Tree** by switch name, IP address, or WWN. You can rest on the cursor over a switch to display the IP address, current status, and other details of the switch. To manually refresh the status of a switch within the fabric, right-click the switch in the **Fabric Tree** and select **Refresh**.

Although **Fabric Tree** displays all the switches in the fabric, you can manage switches that support Fabric OS v6.1 and later versions because it does not require Web Tools license. If a switch is launched from **Fabric Tree**, preference will be given to IPv4, even though both IPv4 and IPv6 are configured for that particular switch.

The versions earlier than Fabric OS v6.1 require a Web Tools license and, if applicable, an EGM license installed. Other switches must be managed through the Fabric OS command line interface (CLI), another management application, or by using Brocade Network Advisor.

Switch View buttons

The **Switch View** buttons let you access the following switch information:

- **Status**—Click the button to view the status of the switch.
- **Temp**—Click the button to view temperature monitors.
- **Power**—Click the button to view power supply information.
- **Fan**—Click the button to view the status of the switch fans.

NOTE

For all status displays based on errors per time interval, any errors cause the status to show faulty until the entire sample interval has passed.

Switch View

You can click the small right arrow towards the left of the **Switch Event** tab to display the **Switch View**. The **Switch View** displays a graphical representation of the switch, including a real-time view of switch and port status. Refer to area 7 in [Figure 5](#) on page 19.

NOTE: With the upgrade license installed:

- For 7800, all FC ports and 6 GbE ports are enabled

Without the upgrade license installed:

- For 7800, 4 FC ports and 2 GbE ports are enabled

NOTE

Blades are graphically represented in the Web Tools GUI. They are vertical in the DCX, and horizontal in the DCX-4S.

The default **Switch View** display refresh rate is 60 seconds. However, the initial display of **Switch Explorer** might take from 30 to 60 seconds after the switch is booted. Refresh rates are fabric-size dependent. The auto refresh interval may not be less than 45 seconds. However, the refresh rate varies depending on the activity in the fabric and on the host system you are using. The larger the fabric, the longer it takes to poll the fabric and refresh the view. F_Port and L_Port connection changes refresh immediately.

Port representations

The ports in the **Switch View** show the port type. Borders around the accessible ports indicate that SFP modules are present. A colored border indicates the status of the port; for example, a green border indicates that the port is connected and traffic is flowing. Ports that are not accessible do not display the port type and do not have borders.

2 Viewing Switch Explorer

When you mouse over a port, a yellow color toggling effect is available to identify the selected port.

The port LEDs in the **Switch View** match the LEDs on the physical switch. However, the blink rate of the LEDs in the **Switch View** does not necessarily match the blink rate of the LEDs on the physical switch. Refer to [“Port LED interpretation”](#) on page 130 for more information.

Right-click a port in **Switch View** to get a menu that opens the **Port Admin** tab, allowing you to view detailed information about the port. From **Port Admin**, you can access information on all other ports. Refer to [Chapter 5, “Managing Ports”](#) for more information.

NOTE

For detailed information on ISL Trunking, F_Port Trunking, and long distance, you must install the EGM license on the switch; otherwise access to these features is denied and an error message is displayed.

E_Ports are visible in all domains. For the Brocade DCX, the Port Admin view is launched for ICL ports.

USB port representation

For switches with USB ports, the **USB Storage Management** view is launched for USB ports ([Figure 6](#)).

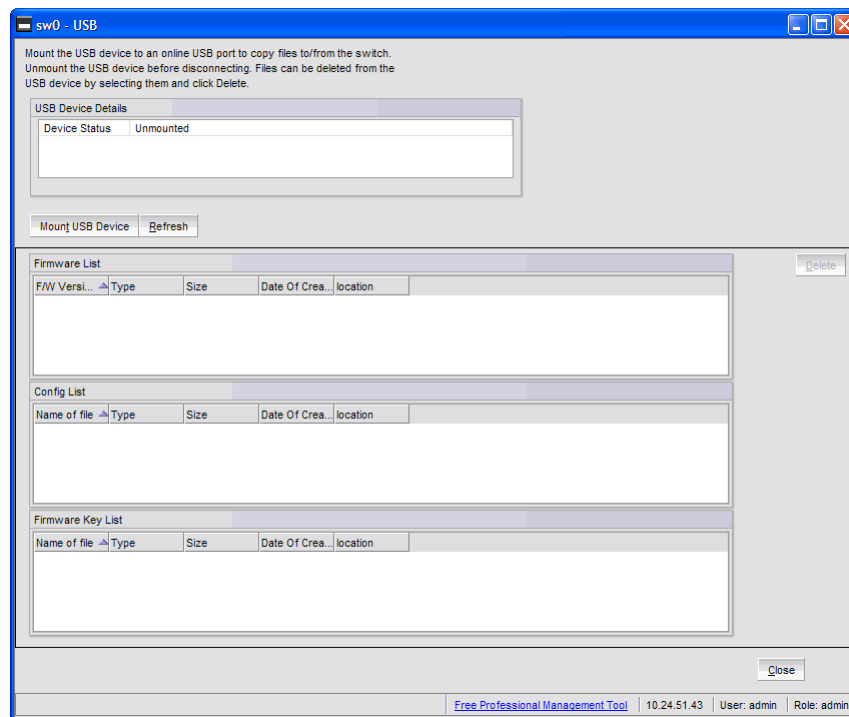

FIGURE 6 USB port storage management

NOTE

Click the USB port on the switch to launch the **USB Storage Management** window.

Switch Events and Switch Information

Switch Events and **Switch Information** display as tab forms under **Switch View**. The information in the **Switch Information** tab is polled every 60 seconds.

NOTE

You can click the column head to sort the events by a particular column, and drag the column divider to resize a column. You can also right-click a column heading to resize one or all columns, sort the information in ascending or descending order, or select which columns are displayed.

The **Switch Information** tab displays information about the following items:

- Switch

- Name Name of the switch.
- Status Status of the switch.
- Fabric OS Version Fabric OS version of the switch.
- Domain ID Domain ID of the switch.
- WWN World Wide Name of the switch.
- Type Type of the switch.
- Role Role of the switch.

The following information is specific to Virtual Fabrics:

- Base Switch Indicates whether or not the logical switch can act as a base switch.
- Default Switch Indicates whether or not the logical switch is the default logical switch.
- Allow XISL Use Indicates whether or not the logical switch is allowed to connect to other logical switches using an extended inter-switch link (XISL).

- Ethernet

- Ethernet IPv4 Ethernet IPv4 address of the switch.
- Ethernet IPv4 netmask Ethernet IPv4 subnet mask address of the switch.
- Ethernet IPv4 gateway Ethernet IPv4 gateway address of the switch.
- Ethernet IPv6 Ethernet IPv6 address of the switch.

- FC

- IPFC IPv4 Fiber Channel IPv4 address.
- IPFC IPv4 net mask Fiber Channel IPv4 subnet mask address.

- Zone

- Effective Configuration Indicates whether zone configuration is enabled or not.

- Other

- Manufacturer serial number Displays the serial number of the manufacturer.
- Supplier serial number Displays the serial number of the supplier.
- License ID Displays the license ID.

2 Displaying tool tips

- RNID
 - Type Type of the switch.
 - Model Model of the switch.
 - Tag Tag of the switch.
 - Sequence number Sequence number of the switch.
 - Insistent Domain ID Current status of the Insistent Domain ID mode of the switch.
Mode
 - Manufacturer Manufacturer of the switch.
 - Manufacturer Plant Plant where the switch was manufactured.

For more information, refer to [“Displaying switch information”](#) on page 125.

Free Professional Management tool

You can use the Professional Management tool with Web Tools to view connectivity for each fabric, to back up and restore last-known configurations, and more. You can also use it with the Enhanced Group Management license to manage groups of switches, download firmware, manage security settings, and deploy configurations across groups of switches. Contact your preferred storage supplier to get a complimentary copy of the Professional Management tool.

Launch the install wizard for the free Professional Management tool through the link located at the bottom of the **Switch Explorer**.

Displaying tool tips

When you rest the cursor over a Web Tools button, the system displays a brief description of the button. If you rest the cursor over most components, the system displays tool tip information about the component.

In the **Fabric Tree** you can rest the cursor over a switch to view its type, subtype, name, Ethernet IPv4 and IPv6 addresses, IPFC, and status of the switch.

In **Switch View**, you can rest the cursor over a blade to view the blade ID and its status. It is easier to use the top of the blade to display the tool tip so that you do not inadvertently display the port tool tips. Firmware versions and IP addressing are displayed for CP blades.

When you rest the cursor over a port, you can view the:

- port name
- port ID
- port beacon
- port number
- port index
- port type (E, F, L, D, Ex, GIGe, or U_Port)
- port status (online or offline)
- port state (in-sync, no_sync, no light, or no module)

Right-click options

You can right-click a port to quickly perform some basic port administration tasks, as shown in [Figure 7](#).

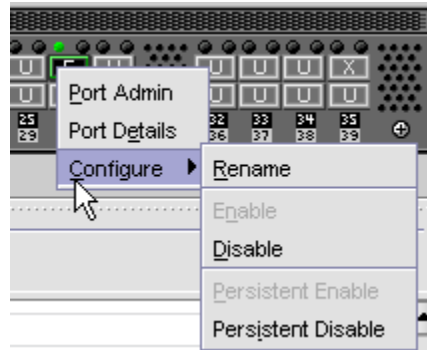

FIGURE 7 Right-click menu for ports (from Switch Explorer)

The tasks are:

- The **Port Admin** option displays the **Port Admin** tab.
- The **Port Details** option displays read-only information about a port, without opening the **Port Admin** tab. You can right-click on the table content to export or copy the information from the **Port Details** window.
- The **Configure** option provides another menu of options to allow you to rename, enable, and disable ports, and to set persistent enable or disable without opening the **Port Admin** tab.

Refresh rates

The refresh, or polling, rates listed in this section and throughout the book indicate the time between the end of one polling period and the start of the next, and not how often the screen is refreshed. A refresh rate of 15 seconds does not ensure that a refresh occurs every 15 seconds. It ensures that the time between each refresh activity is no more than 15 seconds.

Autorefresh intervals might not be exactly 15 seconds. The refresh rate varies depending on the activity in the fabric and on the host system you are using. Following are some variables you should consider when refreshing the fabric:

- **Refresh Now** button is disabled for 6-8 seconds on every click.
- Retrieval time increases when you are in a large fabric because there is more data to retrieve from the switches.
- Processor speed of the system you are using may slow down the refresh rate.
- OS-Job Scheduling if you are using a host-system in the data center impacts the refresh rate.
- JVM-Performance can contribute to causing interval differences between what is on-screen and how long it is actually taking.

2 Displaying switches in the fabric

For these reasons, the time displayed in the port statistics tab might not be refreshed as expected. The counter time indicates only that “this statistics data is retrieved from the switch in this time period.” To ensure the correct information, the time field is updated along with the port statistics data after every refresh.

The refresh rates are different for each module. [Table 6](#) lists polling rates by module. Though these rates are sample rates, they correctly illustrate variance in the refresh rates throughout Web Tools.

TABLE 6 Polling rates

Module	Polling rate
Name Server	User-defined; 15 sec minimum
Zoning Database	60 sec
Fabric Watch	45 sec
Performance Monitor (This feature requires the EGM license.)	30 sec
Port Management	60 sec
FC Routing	45–90 sec, depending on network traffic

Displaying switches in the fabric

If your fabric has more than one switch, you can open Web Tools from one switch and then access other switches. You can also launch Web Tools from the Brocade Network Advisor client as Element Manager. This lets you manage Web Tool requests where the fabric is in a private network.

Launch Web Tools from Brocade Network Advisor if you need to access the fabric from a host that is not in the same network and does not have direct access to the fabric.

NOTE

If you open switches, running Fabric OS v4.4.x or later, from a **Fabric Tree** displayed for a version earlier than a v4.4.x switch, some of the features might be disabled.

To display switches in the fabric, perform the following steps.

1. Open Web Tools as described in [“Opening Web Tools”](#) on page 10 and log in to the switch.
2. If the **Fabric Tree** is not expanded, click the plus sign (+) in the **Fabric Tree** to view all the switches in the fabric.
3. Click a switch in the **Fabric Tree**.

A separate browser dialog box displays the selected switch. (If the launch switch is running a Fabric OS version earlier than v5.0.1, the selected switch displays in the same browser window.)

The graphic of the selected switch displays in **Switch View**. Additional switch information displays in the **Switch Events** and **Switch Information** tabs.

Working with Web Tools: recommendations

Brocades makes the following recommendations for working with Web Tools:

- If you receive an error when saving changes in the **Switch Administration** window, note the error messages, refresh the window, and make your changes again. Do not continue making changes without refreshing the window and determining which changes were saved correctly.
- In a fabric containing switches and directors running different versions of firmware, use the switches or directors with the latest firmware versions to control the fabric.
- If switches are accessed simultaneously from different connections (for example, Web Tools, CLI, and API), changes from one connection might not be updated to the other, and some modifications might be lost. Make sure that, when you connect with simultaneous multiple connections, you do not overwrite the work of another connection.
- Several tasks in Web Tools make fabric-level changes, such as the tasks in **Zone Administration**. When executing fabric-level configuration tasks, wait until you have received confirmation that the changes are implemented before executing any subsequent tasks. For a large fabric, this can take several minutes.
- Some data collection and processing operations in the iSCSI Gateway module might take a long time to complete, especially in large fabrics or fabrics with large numbers of defined Discovery Domains and Discovery Domain Sets. In most cases, progress bars are provided. Allow the application a sufficient amount of time (30-40 seconds) to collect and display data before taking any action or assuming the application is “hanging.”
- A maximum of five simultaneous HTTP sessions to any one switch is recommended. An HTTP session is considered a Brocade Network Advisor or Web Tools connection to the switch.

Opening a Telnet or SSH client window

When you open a Telnet or SSH client window, it connects to the IP interface of the switch. You cannot connect to a CP blade on a director switch through a Telnet or SSH client window opened from Web Tools, even when the blade has an IP address and supports Telnet sessions. Refer to the *Fabric OS Command Reference* for information about the Telnet commands.

NOTE

Internet Explorer 7.0 default settings disable Telnet functionality. If you are using Internet Explorer 7.0, you must make the appropriate changes in the registry to open the Telnet window.

To open a Telnet or SSH client window, perform the following steps.

1. Select a switch in **Fabric Tree**.

You are prompted to log in if the OS is version 5.3.0 or later; otherwise, the selected switch displays in **Switch View**.

2. Select **Telnet/SSH Client** under **Tools** menu. The **Preference Dialog** dialog box displays.
3. Select the client by clicking **Telnet** or **SSH**.
4. Enter the Telnet or SSH path, as defined for your implementation.

To avoid the need to remember and key in the path, you can store the path on your PC and browse to the location. Clicking the button to the right of the field initiates the browse capability.

5. Click **OK**.

The Telnet or SSH window displays.

6. Enter your user credentials at the login prompt.

2 Collecting logs for troubleshooting

7. To close the session, enter **exit** at the prompt and press the **Enter** key.

Collecting logs for troubleshooting

If you encounter problems using the Web Tools interface, collect Java logs for use in troubleshooting. From Microsoft Windows, perform this procedure.

1. Open **Control Panel** and select **Java**.
2. Click on the **Advanced** tab.
3. Expand **Java console**.
4. Select **Show console**.
5. Restart Web Tools.

The Java console displays, along with the Web Tools opening page.

6. Perform the Web Tools operation that caused the problem.
7. Collect the logs shown on the Java console.
8. If you no longer want to see the Java console when you start Web Tools, go back to the **Control Panel**, repeat steps 1 and 2, and then deselect **Show console**.

Managing Fabrics and Switches

In this chapter

- Fabric and switch management overview 29
- Configuring IP and subnet mask information 31
- Configuring Netstat Auto Refresh 32
- Configuring a syslog IP address 32
- Removing a syslog IP address 32
- Configuring IP Filtering 33
- Blade management 33
- Switch configuration 35
- Switch restart 38
- System configuration parameters 39
- Licensed feature management 43
- High Availability overview 45
- Event monitoring 47
- Displaying the Name Server entries 50
- Physically locating a switch using beaconing 52
- Locating logical switches using chassis beaconing 52
- Virtual Fabrics overview 52

Fabric and switch management overview

Most of the management tasks described in this chapter are accessed through the **Switch Administration** window. Information in the **Switch Administration** window is retrieved from the selected switch, as shown in [Figure 8](#) on page 30.

3 Fabric and switch management overview

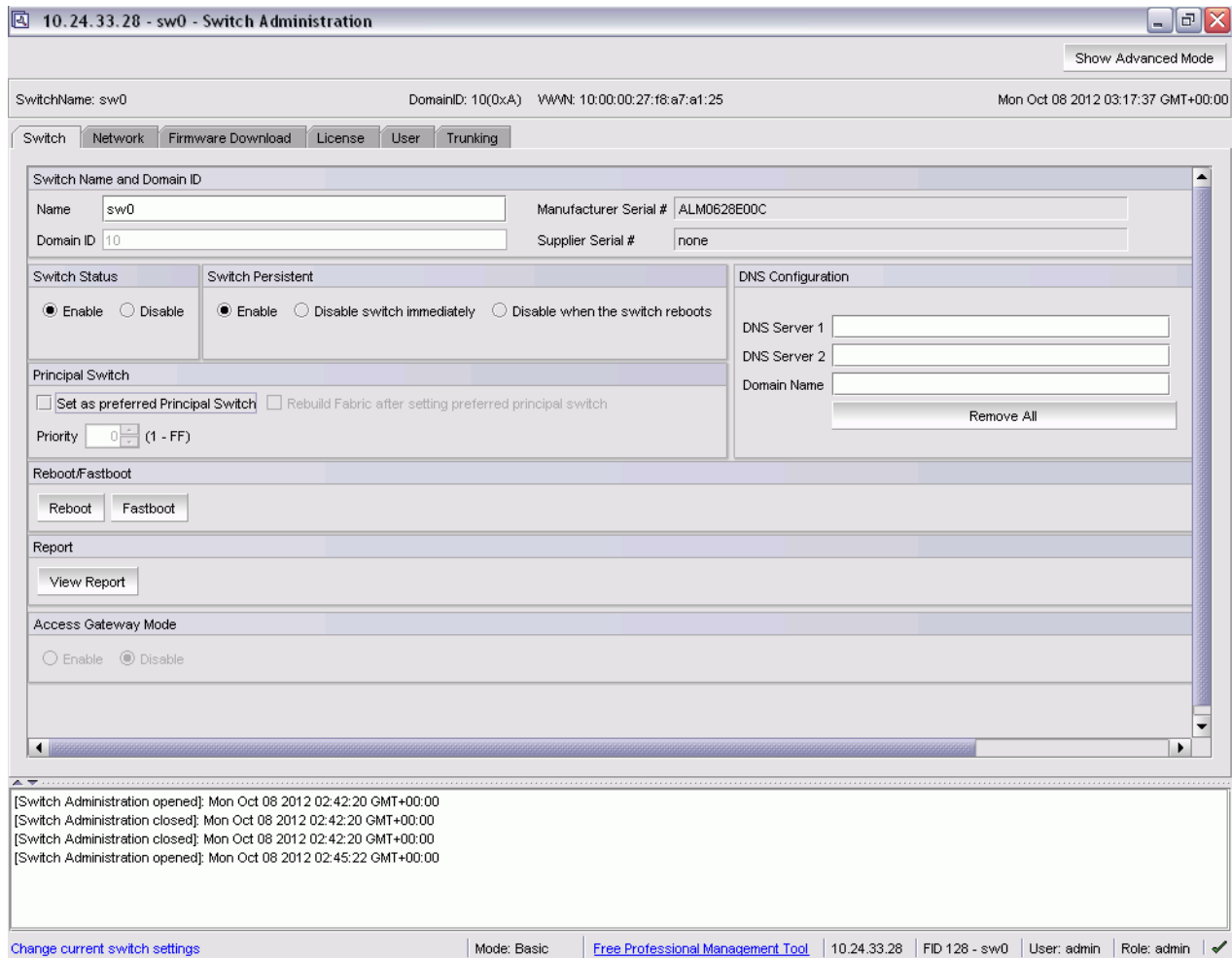

FIGURE 8 Switch Administration window, Switch tab, Basic mode

With the exception of switch time, information displayed in the **Switch Administration** window is not updated automatically by Web Tools. To update the information displayed in the **Switch Administration** window, click the **Refresh** button.

ATTENTION

Most changes you make in the **Switch Administration** window are buffered, and are *not* applied to the switch until you save the changes. If you close the **Switch Administration** window without saving your changes, your changes are lost. To save the buffered changes you make in the **Switch Administration** window to the switch, click **Apply** before closing the module or before switching to another tab.

The **License** tab, **Firmware Download** tab, and the **Security Policies** tab are exceptions. The changes you make on these tabs take effect immediately and there is no **Apply** button. There is an **Apply** button in all the subtabs of security policies except ACL.

You can also use Telnet commands to perform management tasks. Refer to “[Opening a Telnet or SSH client window](#)” on page 27 for information on how to launch a Telnet window using Web Tools.

Opening the Switch Administration window

Most of the management procedures in this chapter are performed from the **Switch Administration** window.

To open the **Switch Administration** window, perform the following steps.

1. Click **Configure > Switch Admin**.

The **Switch Administration** dialog box displays in basic mode, as shown in [Figure 8](#) on page 30. The basic mode displays the “basic” tabs and options.

2. Click **Show Advanced Mode** to see all the available tabs and options.

Configuring IP and subnet mask information

Before proceeding, collect all the information you need to configure the Ethernet IP interface. This includes the subnet mask, gateway IP address, or IPFC, and subnet mask for your system. When you configure or change the Ethernet IP, subnet mask, gateway IP, or IPFC, and subnet mask from Web Tools, there is a normal loss of network connection to the switch. Close all current windows and restart Web Tools with the new IP address.

NOTE

The IPFC address is specific for each logical switch. The IPFC address is set to FC0 for switches that do not support Virtual Fabrics.

To configure the IP and subnet mask information, perform the following steps.

1. Select the **Network** tab.
2. In the appropriate IP address section, enter the IP address you want to use for the IP interface.
Use the **IPv4 Address** section or the **IPv6 Address** section to specify IP addresses.
3. In the **IPv4 Address** section:
 - In the **Ethernet IP** field, enter the Ethernet IP address.
 - In the **IPFC Net IP** field, enter the IPFC net IP address.
 - In the **Ethernet Mask** field, enter the Ethernet mask address.
 - In the **IPFC Net Mask** field, enter the IPFC net mask address.
 - In the **Gateway IP** field, enter the gateway IP address.
4. In the **IPv6 Address** section, in the **Ethernet IPv6** field, enter the Ethernet IP address.
5. You can also enable automatic configuration of IPv6 addresses by selecting **Enable IPv6 Auto Configuration**.

The automatically generated IPv6 addresses are displayed under **Auto Configured IPv6 Addresses**. Eight auto-configured addresses are created per switch, and up to 24 for a DCX, or DCX-4S chassis (eight per chassis, and eight per each installed CP).

Configuring Netstat Auto Refresh

The Netstat Performance window displays the details about Ethernet management port statistics like the Interface, MTU, Met, RX-OK, RX-ERR, RX-DRP, RX-OVR, TX-OK, TX-ERR, TX-DRP, TX-OVR, and Flag.

To configure Auto Refresh, perform the following steps.

1. Open the **Switch Administration** window as described in [“Opening the Switch Administration window”](#) on page 31.
2. Select the **Network** tab.
3. Click **Netstat Performance**.
4. Select the **Auto Refresh** check box to automatically refresh the port details.
Clear the check box to disable auto refresh.
5. When enabled, enter the interval time in seconds in the **Auto-Refresh Interval** field.

The port details are automatically refreshed, based on the configured time interval. The minimum value is 15 seconds.

Configuring a syslog IP address

The syslog IP represents the IP address of the server that is running the syslog process. The syslog daemon reads and forwards system messages to the appropriate log files or users, depending on the system configuration. When one or more IP addresses are configured, the switch forwards all error log entries to the syslog on the specified servers. Up to six servers are supported. Refer to *Fabric OS Administrator's Guide* for more information on configuring the syslog daemon.

To configure a syslog IP address, perform the following steps.

1. Open the **Switch Administration** window as described in [“Opening the Switch Administration window”](#) on page 31.
2. Select the **Network** tab.
3. In the **Syslog IP's Configuration** section, in the **New IP** field, enter an IP address in either IPv4 or IPv6 format.
4. Click **Add**.
The new IP address displays in the Syslog IP area.
5. Click **Apply**.

Removing a syslog IP address

To remove a syslog IP address, perform the following steps.

1. Open the **Switch Administration** window as described in [“Opening the Switch Administration window”](#) on page 31.
2. Select the **Network** tab.
3. Select a syslog IP in the table and click **Remove**.

You can click **Clear All** to remove all of the syslog IP addresses from the table.

4. Click **Apply**.

Configuring IP Filtering

Web Tools provides the ability to control what client IP addresses may connect to a switch or fabric.

To set up IP Filtering, perform the following steps.

1. Open the **Switch Administration** window (in Basic mode) as described in [“Opening the Switch Administration window”](#) on page 31.
2. Click **Show Advanced Mode**.
3. Select the **Security Policies** tab.
4. Select **IPFilter** on the **Security Policies** menu.
5. Click **Create Policy**.

The **Create IP Filter Policy** dialog box displays.

6. Enter a policy name, select a policy type, and then click the **Add Rule** button.
7. Enter the rule order, rule type, source and destination IP addresses, and then modify the service or destination port, protocol, and action as necessary.

Both the source and destination IP addresses are needed for the FWD rule type.

Only the source IP address is needed for the INPUT rule type, as the destination IP address field is disabled.

8. Click **OK**.

After you create a policy, you can use the following controls on this tab to manage the policies:

- The **Edit Policy** button lets you select an existing policy and make changes to it.
- The **Show Policy** button lets you view the details of the policy in a read-only window.
- The **Delete Policy** button lets you delete a policy.
- The **Clone Policy** button lets you copy a policy. Use this feature when you want to create similar policies. After you create a clone, you can edit the policy to make the appropriate changes.
- The **Activate Policy** button lets you make an existing policy active.
- The **Distribute Policy** button lets you distribute a policy to various switches.
- The **Accepts Distribution** check box lets you set the policy to accept or reject distributions.

Blade management

Web Tools provides the ability to enable and disable blades, and to set slot-level IP addresses for blades. The procedure in this section applies only to the Brocade DCX 8510-4, Brocade DCX 8510-8, or the Brocade DCX and DCX-4S enterprise-class platforms.

Enabling or disabling a blade

The **Firmware Version** columns display the firmware loaded onto each blade. A blade can have more than one firmware image loaded onto it. The **Blade State** column in the **Blade** tab pane indicates whether the blade is enabled.

NOTE

The blade state is always shown as enabled, even if you perform a blade disable operation. When a blade is set to a disable state, only the ports on the blade are disabled. The blade remains active.

To enable or disable a blade, perform the following steps.

1. Open the **Switch Administration** window as described in “Opening the Switch Administration window” on page 31.
2. Select the **Blade** tab (Figure 9).

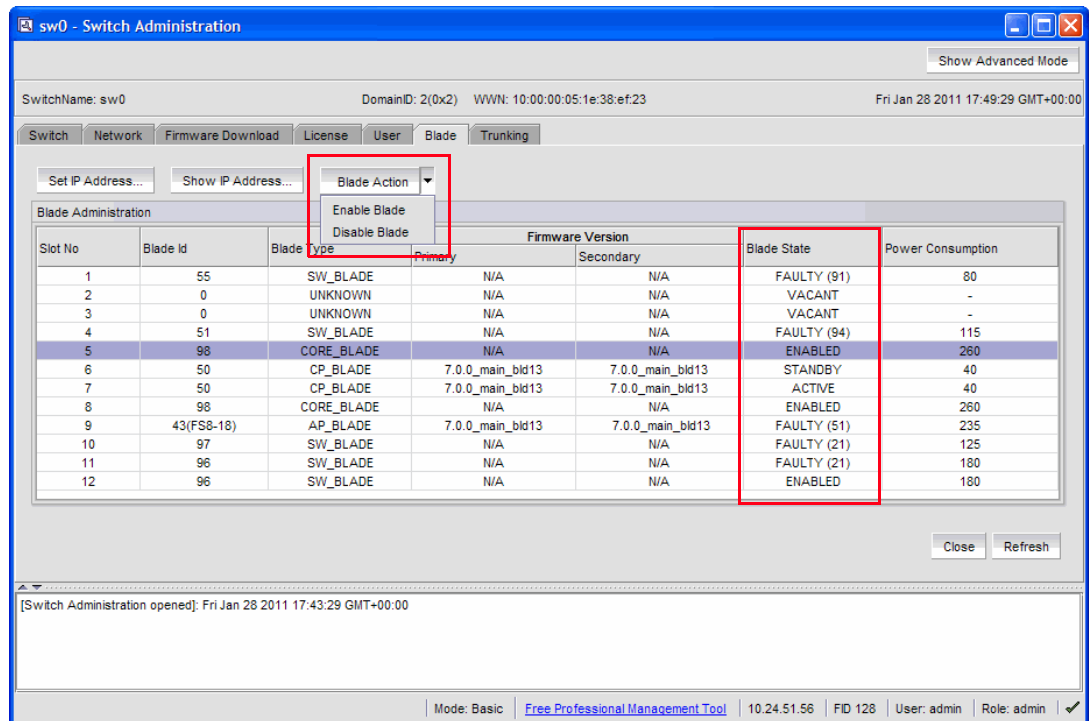

FIGURE 9 Blade tab

3. Select **Blade Action > Enable Blade** for each blade you want to enable, or **Blade Action > Disable Blade** to disable a blade, and click **Yes** in the confirmation dialog.

Disabling a blade does not turn off the blade, it disables the ports on the blade. You cannot enable or disable the CP blades.

Setting a slot-level IP address

To set an IP address, perform the following steps.

1. Open the **Switch Administration** window as described in [“Opening the Switch Administration window”](#) on page 31.
2. Select the **Blade** tab.
3. Click **Set IP address**.
4. Select a slot number from the list.
5. Enter the IP address, subnet mask, and Gateway IP address.
6. Select a type from the list.
7. Click **Add** to add the new entry to the table.

When you click **Add**, the values remain in the fields. The **Clear Gateway** and **Clear IP** buttons are available for clearing fields in the table.

NOTE

To remove a configuration, select a row in the table and click **Delete**.

8. Click **Apply** to save the values currently shown in the table or click **Cancel** to close the dialog box without saving any of your changes.
9. To update the switch with your changes, update the table using the **Add** and **Delete** buttons, and then click **Apply**.

Viewing IP addresses

If you want to view the IP addresses configured on the switch for the currently populated slots, use the **Show IP Address** button.

Use this procedure to display the IP addresses.

1. Open the **Switch Administration** window as described in [“Opening the Switch Administration window”](#) on page 31.
2. Select the **Blade** tab.
3. Click **Show IP Address**.
4. Scroll through the list to view all the information.
5. When you are finished, click **Close**.

Switch configuration

Use the **Switch** tab of the **Switch Administration** window to perform basic switch configuration. [Figure 8](#) on page 30 displays an example of the **Switch** tab.

Enabling and disabling a switch

You can identify whether a switch is enabled or disabled in the **Switch Administration** window by looking at the lower-right corner. If you rest the cursor over the icon, the system displays text that indicates the status of the switch.

Use this procedure to enable or disable a switch.

3 Switch configuration

1. Open the **Switch Administration** window as described in [“Opening the Switch Administration window”](#) on page 31.
2. Select the **Switch** tab.
3. In the **Switch Status** section, click **Enable** to enable the switch or **Disable** to disable the switch.
4. Click **Apply**.

The system displays a confirmation window that asks if you want to save the changes to the switch. You must click **Yes** to save the changes.

Enabling and disabling switch persistent

Use this procedure to enable or disable switch persistent. By default, switch persistent is disabled.

1. Open the **Switch Administration** window as described in [“Opening the Switch Administration window”](#) on page 31.
2. Select the **Switch** tab.
3. In the **Switch Persistent** section, do one of the following:
 - Click **Enable** to enable the switch persistent
 - Click **Disable switch immediately** to disable the switch persistent immediately.
 - Click **Disable when the switch reboots** to set the switch persistent in disabled state and disable on reboot.

The switch remains in enabled or temporarily online state until it reboots. After reboot, switch goes to disabled state.

4. Click **Apply**.

The system displays a confirmation window that asks if you want to save the changes to the switch. You must click **Yes** to save the changes.

Changing the switch name

Switches can be identified by IP address, domain ID, World Wide Name (WWN), or switch names. Names must begin with an alphabetic character, but otherwise can consist of alphanumeric, hyphen, and underscore characters. The maximum number of characters is 30, unless FICON mode is enabled. When FICON mode is enabled, the maximum number of characters is 24.

NOTE

Some system messages identify a switch service by the chassis name. If you assign meaningful chassis names and switch names, system logs are easier to use.

1. Open the **Switch Administration** window as described in [“Opening the Switch Administration window”](#) on page 31.
2. Select the **Switch** tab.
3. Enter a new name in the **Name** field and click **Apply**.

Changing the switch domain ID

Although domain IDs are assigned dynamically when a switch is enabled, you can request a specific ID to resolve a domain ID conflict when you merge fabrics.

To change the switch domain ID, perform the following steps.

1. Open the **Switch Administration** window as described in [“Opening the Switch Administration window”](#) on page 31.
2. Disable the switch, as described in [“Enabling and disabling a switch”](#) on page 35.
3. Select the **Switch** tab.
4. Enter a new domain ID in the **Domain ID** field.
For IMO, the range of valid values is from 1 through 239.
5. Click **Apply**.
6. Enable the switch, as described in [“Enabling and disabling a switch”](#) on page 35.

Viewing and printing a switch report

The switch report includes the following information:

- A list of switches in the fabric
- Switch configuration parameters
- A list of ISLs and ports
- Name Server information
- Zoning information
- SFP serial ID information

To view or print a report, perform the following steps.

1. Open the **Switch Administration** window as described in [“Opening the Switch Administration window”](#) on page 31.
2. Select the **Switch** tab.
3. Click **View Report**.
4. In the new window that displays the report, view or print the report using your browser.

Setting a principal switch

To set the preference to a switch to become the next principal switch in the fabric, perform the following steps:

NOTE

Principal switch selection is not supported in Access Gateway mode.

1. Open the **Switch Administration** window as described in [“Opening the Switch Administration window”](#) on page 31.
2. Select the **Switch** tab.

3 Switch restart

3. In the **Principal Switch** section, perform one of the following to set the switch as a principal switch.
 - Select **Set as preferred Principal Switch** - The switch is set as principal switch in the next fabric rebuild.
 - Select **Set as preferred Principal Switch** and then select **Rebuild Fabric after setting preferred principal switch** - The switch is set as preferred principal switch with rebuild triggered forcefully.
 - Select **Set as preferred Principal Switch** and enter the priority value in a range from 1 through FF in the **Priority** field.

You can change the priority value and select **Rebuild Fabric after setting preferred principal switch** option from a principal or a subordinate switch. The principal switch selection is based on the following factors:

	Priority value with force option	Expected behavior
Subordinate switch	Lesser than principal	Fabric rebuild occurs and the switch comes up as a principal switch.
	Greater than principal	Fabric rebuild occurs and the switch remains as a subordinate switch.
	Equal to principal	Fabric rebuild occurs and the principal switch is selected based on the wwn check (lower becomes principal switch).
Principal switch	Lesser than subordinate	No fabric rebuild, the switch remains principal.
	Greater than subordinate	Fabric rebuild occurs and the switch becomes subordinate.
	Equal to subordinate	Fabric rebuild occurs and the principal switch is selected based on the wwn check (lower becomes principal switch).

4. Click **Apply**.

Switch restart

When you restart the switch, the restart takes effect immediately. Ensure that there is no traffic or other management on the switch, because traffic is interrupted during the restart; however, frames are not dropped. Be sure to save your changes before the restart, because any changes not saved are lost.

Performing a fast boot

A fast boot reduces boot time significantly by bypassing the power-on self test (POST).

To perform a fast boot, perform the following steps.

1. Open the **Switch Administration** window as described in [“Opening the Switch Administration window”](#) on page 31.
2. Click **Fastboot**.
3. On the **Fastboot Confirmation** window, click **Yes** to continue.

4. Click **Apply**.

Performing a reboot

To reboot the CP and execute the normal power-on booting sequence, perform the following steps.

1. Open the **Switch Administration** window as described in [“Opening the Switch Administration window”](#) on page 31.
2. Click **Reboot**.
3. On the **Reboot Confirmation** window, click **Yes** to continue.
4. Click **Apply**.

System configuration parameters

You must disable the switch before you can configure fabric parameters.

You can change the following system configuration parameters:

- Switch fabric settings
- Virtual channel settings
- Arbitrated loop parameters
- System services
- Signed firmware

WWN-based Persistent PID assignment

WWN-based PID assignment allows you to configure a PID persistently using a device's WWN. When the device logs into the switch, the PID is bound to the device WWN. If the device is moved to another port in the same switch, or a new blade is hot plugged, the device receives the same PID (area) at its next login. For information on configuring WWN-based PID assignment, refer to [“Configuring fabric settings”](#) on page 40.

This feature is deactivated by default. When the feature is enabled, bindings are created dynamically; as new devices log in, they automatically enter the WWN-based PID database. The bindings exist until you explicitly unbind the mappings through the CLI or change to a different addressing mode. If there are any existing devices when you enable the feature, you must manually enter the WWN-based PID assignments through the CLI.

Once WWN-based PID assignment is enabled you must manually enter the WWN-based PID assignments through the CLI for any existing devices. Any new devices logging in are automatically entered in the WWN-based PID database. Current WWN-based PID bindings are cleared when you change to a different addressing mode.

PID assignments are supported for a maximum of 4096 devices; this includes both point-to-point and NPIV devices. The number of point-to-point devices supported depends directly on the areas available. For example, 448 are available on an enterprise-class platform and 256 are available on switches. When the number of entries in the WWN-based PID database reaches the number 4096 or areas are used up, the oldest unused entry is purged from the database to free up the reserved area for the new FLOGI. Refer to [Table 7](#) for complete information.

3 System configuration parameters

TABLE 7 Switches that support WWN-based Persistent PID on Web Tools

Platform	VF	Default switch	Logical switch	Area mode	FICON mode
DCX/DCX-4S DCX 8510-4 DCX 8510-8	Enabled	Yes, if dynamic area addressing is enabled in the default switch.	Yes	0 1 2	If 8-bit dynamic mode is enabled, FMS is not supported Can be set Not supported
Brocade 5100 Brocade 5300 Brocade VA-40FC Brocade 6510 Brocade 6520	Enabled	Yes	Yes	Default-8 bit dynamic	Configurable
Brocade 300 Brocade 5100 Brocade 5300 Brocade VA-40FC Brocade 6510 Brocade 6520 Brocade 7800	Disabled	N/A	N/A	Default-8bit dynamic	Configurable

Configuring fabric settings

To configure the fabric settings, perform the following steps.

1. Open the **Switch Administration** window as described in [“Opening the Switch Administration window”](#) on page 31.
2. Click **Show Advanced Mode**.
3. Select the **Configure** tab.
4. Select the **Fabric** subtab.
5. Make the fabric parameter configuration changes.
6. Click **Apply**.
7. Enable the switch as described in [“Enabling and disabling a switch”](#) on page 35.

Fabric settings

Configure the following fabric settings on the **Fabric** subtab of the **Configure** tab:

BB Credit	The buffer-to-buffer credit is the number of buffers available to attached devices for frame receipt. The default BB Credit is 16. The range of valid values is from 1 through 27.
R_A_TOV	Resource allocation timeout value (in milliseconds). This variable works with the E_D_TOV to determine switch actions when presented with an error condition. The default is 10000. The possible range is (2*E_D_TOV) - 120000. Values must be multiples of 1000.
E_D_TOV	Error detect timeout value (in milliseconds). This timer is used to flag a potential error condition when an expected response is not received within the set time. The valid range is 1000 - (R_A_TOV/2)

Datafield size	The largest possible data field size (in bytes). The range of valid values is from 256 through 2112.
Address mode	Displays the addressing mode present in the switch.
Sequence Level Switching	Select this box to enable frames of the same sequence from a particular group to be transmitted together. When this option is not selected, frames are transmitted interleaved among multiple sequences. Under normal circumstances, sequence-level switching should be disabled for better performance. However, some host adapters have issues when receiving interleaved frames among multiple sequences.
Disable Device Probing	Set this mode only if the switch N_Port discovery process (PLOGI, PRLI, INQUIRY) causes an attached device to fail. When set, devices that do not register with the Name Server are not present in the Name Server database.
Per-Frame Routing Priority	Select whether to select per-frame routing priority. When enabled, the virtual channel ID is used in conjunction with a frame header to form the final virtual channel ID.
Suppress Class F Traffic	Applies only if VC-encoded address mode is also set. When selected, translatable addressing (which allows private devices to communicate with public devices) is disabled.
Insistent Domain ID Mode	Set this mode to make the current domain ID insistent across reboots, power cycles, and failovers. This mode is required fabric wide to transmit FICON data.
WWN-based Persistent PID	Set this mode to configure a PID persistently using a device's WWN. When the device logs into the switch, the PID is bound to the device WWN. Refer to “WWN-based Persistent PID assignment” on page 39.

Enabling insistent domain ID mode

To enable insistent domain ID mode, perform the following steps.

1. Open the **Switch Administration** window as described in [“Opening the Switch Administration window”](#) on page 31.
2. Disable the switch as described in [“Enabling and disabling a switch”](#) on page 35.
3. Select the **Configure** tab.
4. Select the **Fabric** subtab.
5. Select the **Insistent Domain ID Mode** check box.
6. Click **Apply**.
7. Enable the switch as described in [“Enabling and disabling a switch”](#) on page 35.

Configuring virtual channel settings

You can configure parameters for eight virtual channels (VC) to enable fine-tuning for a specific application. You cannot modify the first two virtual channels because these are reserved for switch internal functions.

ATTENTION

The default virtual channel settings are already optimized for switch performance. Changing the default values can improve switch performance, but can also degrade performance. Do not change these settings without fully understanding the effects of the changes.

VC Priority specifies the class of frame traffic given priority for a virtual channel.

To configure the virtual channel settings, perform the following steps.

3 System configuration parameters

1. Open the **Switch Administration** window as described in [“Opening the Switch Administration window”](#) on page 31.
2. Disable the switch as described in [“Enabling and disabling a switch”](#) on page 35.
3. Select the **Configure** tab.
4. Select the **Virtual Channel** subtab.
5. Enter a value in the **VC Priority** field you want to change.
The only valid numeric values for all fields are either “2” or “3”.
6. Click **Apply**.
7. Enable the switch as described in [“Enabling and disabling a switch”](#) on page 35.

Configuring arbitrated loop parameters

To configure arbitrated loop parameters, perform the following steps.

1. Open the **Switch Administration** window as described in [“Opening the Switch Administration window”](#) on page 31.
2. Disable the switch as described in [“Enabling and disabling a switch”](#) on page 35.
3. Select the **Configure** tab.
4. Select the **Arbitrated Loop** subtab.
5. Select or clear the check boxes to enable or disable the corresponding arbitrated loop parameters.
6. Click **Apply**.
7. Enable the switch as described in [“Enabling and disabling a switch”](#) on page 35.

Arbitrated loop parameters

Configure the following arbitrated loop parameters on the **Arbitrated Loop** subtab of the **Configure** tab:

Send Fan Frames	Select this check box to specify that fabric address notification (FAN) frames are sent to public loop devices to notify them of their node ID and address.
Always Send RSCN	Following the completion of loop initialization, a remote state change notification (RSCN) is issued when FL_Ports detect the presence of new devices or the absence of pre-existing devices. Select this check box to issue an RSCN upon completion of loop initialization, regardless of the presence or absence of new or pre-existing devices.

Configuring system services

You can enable or disable FCP read link status (RLS) probing for F_Ports and FL_Ports. It is disabled by default.

To configure system services, perform the following steps.

1. Open the **Switch Administration** window as described in “[Opening the Switch Administration window](#)” on page 31.
2. Disable the switch as described in “[Enabling and disabling a switch](#)” on page 35.
3. Select the **Configure** tab.
4. Select the **System** subtab.
5. Select the **Disable RLS Probing** check box to *disable* RLS probing.
-or-
Clear the check box to *enable* RLS probing.
6. Click **Apply**.
7. Enable the switch as described in “[Enabling and disabling a switch](#)” on page 35.

Configuring signed firmware

When the firmware is downloaded to a device, the system can validate the firmware based on a configuration setting. By default, the signed firmware download is not validated.

NOTE

During the first download, the system ignores the signed firmware. After the first download, the public key is downloaded and then, in subsequent downloads, you can turn on the feature. You can view the public key on the **Firmware Download** tab in the **Switch Administration** window.

To configure the signed firmware, perform the following steps.

1. Open the **Switch Administration** window as described in “[Opening the Switch Administration window](#)” on page 31.
2. Select the **Configure** tab.
3. Select the **Firmware** subtab.
4. Select the **Enable Signed Firmware Download** check box.
5. Click **Apply**.

Licensed feature management

The licensed features currently installed on the switch are listed in the **License** tab of the **Switch Administration** window. If the feature is listed, such as the EGM license, it is installed and immediately available. When you enable some licenses, such as ISL Trunking, you might need to change the state of the port to enable the feature on the link. For time-based licenses, the expiry date is included. Right-click a license key to export data, copy data, or search the table.

Activating a license on a switch

Before you can unlock a licensed feature, you must obtain a license key. You can either use the license key provided in the paperpack document supplied with switch software or refer to the *Fabric OS Administrator's Guide* for instructions on how to obtain a license key at the Brocade website (my.brocade.com).

To activate a license, perform the following steps.

1. Open the **Switch Administration** window as described in [“Opening the Switch Administration window”](#) on page 31.
2. Select the **License** tab and click **Add**.
The **Add License** dialog box displays.
3. Paste or enter a license key in the field.
4. Click **Add License**.
5. Click **Refresh** to display the new licenses in the **License** tab.

Some licenses, such as the Trunking or Brocade 7800 upgrade license, do not take effect until the switch is restarted.

Assigning slots for a license key

This feature allows to increase the capacity without disrupting the slots that already have licensed features running.

NOTE

You can enable slot based licenses only on 10 Gigabit Ethernet (FTR_10G), Advanced Extension (FTR_AE), and Advanced FICON Acceleration (FTR_AFA) features.

To assign slots for a license key, perform the following steps.

1. Open the **Switch Administration** window as described in [“Opening the Switch Administration window”](#) on page 31.
2. Select the **License** tab.
3. Select the license key for which you want to assign slots from the **License Administration** table.
4. Click **Assign Slot(s)**.
The **Assign Slots** window displays.
5. Select the slots you want to assign.
6. Click **OK**.

Removing a license from a switch

To remove a license from a switch in the **Switch Administration** window, perform the following steps.

ATTENTION

Use care when removing licenses. If you remove a license for a feature, that feature no longer works.

1. Open the **Switch Administration** window as described in [“Opening the Switch Administration window”](#) on page 31.
2. Select the **License** tab.
3. Select the license key you want to remove.
4. Click **Remove**.

Universal time-based licensing

After v6.3.0, Web Tools supports universal time-based licensing. Each universal key is for a single feature, and can be used on any product that supports the feature, for a defined trial period. At the end of the trial period, the feature gets disabled. You can extend the universal key license. For time-based licenses, the **Expiry Date** displays in the **License Administration** table.

The following features are supported for universal time-based license:

- Fabric
- Extended Fabric
- Fabric Watch
- Performance Monitor
- Trunking
- High-Performance Extension over FCIP/FC
- Advanced Extension
- Advanced FICON Acceleration
- FICON Management Server (CUP)
- Enhanced Group Management (EGM)
- 10GbE
- Integrated Routing
- Adaptive Networking
- Server Application Optimization
- Extended Inter Chassis Link (EICL) license

High Availability overview

High-Availability (HA) features provide maximum reliability and nondisruptive replacement of key hardware and software modules. High Availability is available only on the Brocade DCX, DCX-4S, DCX 8510-4 and DCX 8510-8 platforms. Refer to the *Fabric OS Administrator's Guide* for additional information about High Availability.

The High Availability window, as shown in [Figure 10](#), displays information about the status of the HA feature on each control processor (CP), and enables you to perform CP failover.

The background color of the HA button indicates the overall status of high availability on the switch. The colors and their meanings are:

- **Green**—Healthy: HA Status is **HA enabled, Heartbeat Up, HA State synchronized**.
- **Yellow**—Disruptive mode: HA Status is **HA enabled, Heartbeat Up, HA State not in sync**.
- **Red**—HA is unavailable: HA Status is **Non-Redundant**.

Launching the High Availability window

To launch the High Availability window, perform the following steps.

3 High Availability overview

1. Select a Brocade DCX, DCX-4S, DCX 8510-4 or DCX 8510-8 platforms from the **Fabric Tree**.
The **Switch View** displays.
2. Click the **HA** button in the **Switch View**.
The **High Availability** dialog box displays.

The **High Availability** window contains the following two tabs:

- The **Service** tab displays information about the switch. When the hardware is configured as a dual switch, the **Service** tab displays information about both switches.
- The **CP** tab displays information about slots. For Brocade DCX-4S or DCX 8510-4, CP blades are placed in slot 4 and slot 5.,For the Brocade DCX or DCX 8510-8, CP blades are placed in slot 6 and 7.

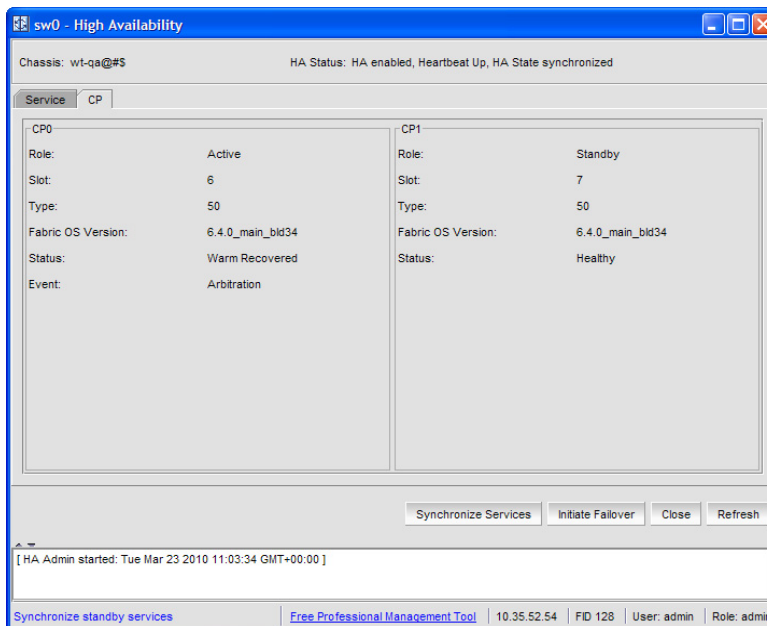

FIGURE 10 High Availability window, CP tab

The **High Availability** window gets refreshed automatically. You can also click **Refresh** to update the information displayed in the **High Availability** window.

Synchronizing services on the CP

A nondisruptive CP failover is only possible when *all* the services are synchronized between both CPs.

To synchronize services on the CP, perform the following steps.

1. Open the **High Availability** window as described in “[Launching the High Availability window](#)” on page 45.
2. Verify that the **HA Status** field displays **HA enabled, Heartbeat Up, HA State synchronized**.

If the **HA Status** field displays **HA enabled, Heartbeat Up, HA State synchronized**, then the services are in sync.

If the **HA Status** field displays **HA enabled, Heartbeat Up, HA State not in sync**, continue with step 3.

3. Click **Synchronize Services**.

The **Warning** dialog box displays.

4. Click **Yes** and wait for the CPs to complete a synchronization of services, so that a nondisruptive failover is ready.
5. Click **Refresh** to update the **HA Status** field.

When the **HA Status** field displays **HA enabled, Heartbeat Up, HA State synchronized**, a failover can be initiated without disrupting frame traffic on the fabric.

Initiating a CP failover

A nondisruptive failover might take about 30 seconds to complete. During the failover, all of the Web Tools windows and all associated child-windows are invalidated. You must close all Web Tools windows and open Web Tools again.

To initiate a nondisruptive failover, perform the following steps.

1. Open the **High Availability** window as described in [“Launching the High Availability window”](#) on page 45.
2. Verify that the **HA Status** field displays **HA enabled, Heartbeat Up, HA State synchronized** or **HA enabled, Heartbeat Up, HA State not in sync**.
3. Click **Initiate Failover**.
The **Warning** dialog box displays.
4. Click **Yes** to initiate a nondisruptive failover.
5. When prompted, close the Web Tools **Switch Explorer** window and all associated windows, and re-open Web Tools.

Event monitoring

Web Tools displays fabric-wide and switch-wide events. Event information includes sortable fields for the following:

- Switch name
- Message number
- Time stamp
- Indication of whether the event is from a logical switch or a chassis
- The number of successive events of the same kind
- Severity level
- Unique message identifier (in the form *moduleID-messageType*)
- Detailed error message for root cause analysis

There are eight message severity levels:

- Emergency









3 Event monitoring

- Alert
- Critical
- Error
- Warning
- Marginal
- Notice
- Information
- Debug

Table 8 lists the event message severity levels displayed on the **Switch Events** tab and explains what qualifies event messages to be certain levels.

On the **Switch Events** tab, you can click **Filter** to launch the **Event Filter** dialog box. The **Event Filter** dialog box allows you to define which events should be displayed on the **Switch Events** tab. For more information on filtering events, refer to [“Filtering Switch Events”](#) on page 49.

TABLE 8 Event severity levels

Icon and level	Description
 Emergency	Emergency-level messages indicate a partial or complete failure of a subsystem.
 Critical	Critical-level messages indicate that the software has detected serious problems that will eventually cause a partial or complete failure of a subsystem if not corrected immediately. For example, a power supply failure or rise in temperature must receive immediate attention.
 Alert	This event does not compromise data or prevent the use of the system; however, the event warrants your attention.
 Error	Error-level messages represent an error condition that does not impact overall system functionality significantly. For example, error-level messages might indicate timeouts on certain operations, failures of certain operations after retries, invalid parameters, or failure to perform a requested operation.
 Warning	Warning-level messages highlight a current operating condition that should be checked or it might lead to a failure in the future. For example, a power supply failure in a redundant system relays a warning that the system is no longer operating in redundant mode. The failed power supply must be replaced or fixed.
 Notice	Notices report important events, such as task completions or events.
 Info	Information-level messages report the current nonerror status of the system components, such as the online and offline status of a fabric port.
 Debug	Debug messages deliver status messages relating to debugging systems.

Displaying Switch Events

The **Switch Events** tab displays a running log of events for the selected switch. Switch events are polled and updated every 15 seconds; there is no refresh-on-demand option for switch events.

For two-switch configurations, all chassis-related events are displayed in the event list of each logical switch for convenience.

To display Switch Events, perform the following steps.

1. Select the switch from the **Fabric Tree**.
The **Switch View** displays.
2. Select the **Switch Events** tab, if necessary.

Filtering Switch Events

You can filter the fabric and switch events by time, severity, message ID, and service. You can apply either one type of filter at a time or multiple types of filters at the same time. When a filter is applied, the filter information displays at the bottom of the filtered information and the **Show All** link is available to allow you to view the information unfiltered.

To filter switch events, perform the following the procedure.

1. Open the **Switch Events** tab as described in [“Displaying Switch Events”](#) on page 49.
2. Click **Filter**.
The **Event Filter** dialog box displays.
3. To filter events within a certain time period:
 - Select the **From** check box and enter the start time and date in the fields.
 - Select the **To** check box and enter the finish time and date in the fields.
 - To filter events beginning at a certain date and time, select only the **From** check box and enter the start time and date.
 - To filter events up until a certain date and time, select only the **To** check box and enter the finish time and date.
4. Click **OK**.
The filter is enabled and the window is refreshed to show the filtered information.

Filtering events by event severity levels

To filter events by event severity levels, perform the following steps.

1. Open the **Switch Events** tab as described in [“Displaying Switch Events”](#) on page 49.
2. Click **Filter**.
The **Event Filter** dialog box displays.
3. Select **Level**.
4. Select the event levels you want to display.
5. Click **OK**.

The filter is enabled and the window is refreshed to show the filtered information.

Filtering events by message ID

To filter events by message ID, perform the following steps.

1. Open the **Switch Events** tab as described in [“Displaying Switch Events”](#) on page 49.
2. Click **Filter**.

The **Event Filter** dialog box displays.

3. Select **Message ID**.
4. Enter the message IDs in the associated field.

NOTE

You can enter multiple message IDs as long as you separate them by commas. You can enter either the full message ID (moduleID-messageType) or a partial ID (moduleID only). The message ID filtering is case-sensitive.

5. Click **OK**.

The filter is enabled and the window is refreshed to show the filtered information.

Filtering events by service component

To filter events by service component, perform the following steps.

1. Open the **Switch Events** tab as described in [“Displaying Switch Events”](#) on page 49.
2. Click **Filter**.

The **Event Filter** dialog box displays.

3. Select **Service**. The event service menu is enabled.
4. Select either **Switch** or **Chassis** from the menu to show only those messages from the logical switch or from the chassis.
5. Click **OK**.

The filter is enabled and the window is refreshed to show the filtered information.

Displaying the Name Server entries

Web Tools displays Name Server entries listed in the Simple Name Server database. This includes all Name Server entries for the fabric, not only those related to the local domain. Each row in the table represents a different device. You can click the column head to sort the events by a particular column, and drag the column divider to resize a column. You can also right-click a column heading to resize one or all columns, sort the information in ascending or descending order, or select which columns are displayed.

For FICON devices: The **Name Server** table lists the request node identification (RNID) information.

To display the Name Servers, perform the following steps.

1. In the **Switch Explorer** window, select **Name Server**.
The **Name Server** tab displays.
2. To set an autorefresh rate for the **Name Server** entries, select the **Auto Refresh** check box in the **Name Server** window, and enter an auto-refresh interval (in seconds).
The minimum interval is 45 seconds and the default interval is 60 seconds.

Printing the Name Server entries

To set up printing preferences, perform the following steps.

1. In the **Switch Explorer** window, select **Name Server**.
The **Name Server** tab displays.
2. Click **Print**.
3. On the **Page Setup** dialog box, set up your printing preferences and click **OK**.
The **Print** dialog box displays.
4. Select a printer and click **OK**.

Displaying Name Server information for a particular device

To display Name Server information for a particular device, perform the following steps.

1. In the **Switch Explorer** window, select **Name Server**.
The **Name Server** tab displays.
2. Select a device from the **Domain** column.
3. Click **Detail View**.
The **Name Server Information** dialog box displays the information specific to that device.

Displaying zone members for a particular device

To display zone members for a particular device, perform the following steps.

1. In the **Switch Explorer** window, select **Name Server**.
The **Name Server** tab displays.
2. Select a device from the **Domain** column.
3. Click **Accessible Devices**.
The **Zone Accessible Devices** window displays accessible zone member information specific to that device.

Physically locating a switch using beaconing

Use the **Beacon** button to physically locate a switch in a fabric. The beaconing function helps to physically locate a switch by sending a signal to the specified switch, resulting in an LED light pattern that cycles through all ports for each switch (from left to right).

NOTE

You must have an RBAC role of admin to initiate switch beaconing. The LED light pattern is initiated on the actual switch or chassis. It is not mirrored in the **Switch View**.

To use beaconing, perform the following steps.

1. Select a logical switch from the **Logical Switch** drop-down list in the top-right corner of the **Switch Explorer** window.

The selected switch displays in the **Switch View**.

2. Select **Tools > Beacon > Beacon** for a switch or **Chassis Beacon** for a chassis-based switch.

The LED lights on the actual switch light up on the physical switch in a pattern running back and forth across the switch itself. In chassis-based switches, the LEDs glow across all the blades.

3. Look at the physical switches in your installation location to identify the switch.

Locating logical switches using chassis beaconing

To locate all logical switches in a chassis, perform the following steps.

1. Select a logical switch from the **Logical Switch** drop-down list in the top-right corner of the **Switch Explorer** window.

The selected switch displays in the **Switch View**.

2. Select **Tools > Beacon > Chassis Beacon**.

The LEDs on the logical switch light up on the blades associated with the logical switch.

Virtual Fabrics overview

Virtual Fabrics is an architecture that virtualizes hardware boundaries. Traditionally, SAN design and management is done at the granularity of a physical switch. Each switch and all the ports in the switch act as a single fabric element that participates in a single fabric. Virtual Fabrics allows SAN design and management to be done at the granularity of a port. This enables partitioning of a physical switch into multiple logical switches, which may be organized into logical fabrics.

The following platforms are Virtual Fabrics-capable:

- Brocade DCX and DCX-4S
- Brocade 5300
- Brocade 5100
- Brocade 6510
- Brocade 6520

- Brocade DCX 8510-4
- Brocade DCX 8510-8

Virtual Fabrics cannot be configured or managed from Web Tools. Configuration and management is done from either the Brocade Network Advisor, or the Fabric OS command line interface. For information about configuring and managing Virtual Fabrics, refer to the *Brocade Network Advisor User Manual* if you are using Brocade Network Advisor, or *Fabric OS Administrator's Guide* if you are using the Fabric OS command line interface.

You can use Web Tools to view Virtual Fabrics and logical switch configurations.

Selecting a logical switch from the Switch View

You can log in to a specific logical switch, as described in Chapter 1, or you can select a logical switch from the **Switch View**. If you do not log in to a specific logical switch, you are presented with the default logical switch.

Under the **Switch Information** tab, **Base Switch**, **Default Switch**, and **Allow XISL Use** are specific to Virtual Fabrics. These options perform these functions:

- **Base Switch** indicates whether or not the logical switch can act as a base switch. A base switch is a special logical switch that can be used for chassis interconnection. Each chassis may only designate only one logical switch as a base switch.
- **Default Switch** indicates whether or not the logical switch is the default logical switch. The default logical switch is equivalent to the normal, discovered physical switch topology. It is automatically assigned fabric ID 128. If you do not log in to a specific logical switch using **Options** on the login dialog box, the default logical switch displays in the **Switch View**.
- **Allow XISL Use** indicates whether or not the logical switch is allowed to connect to other logical switches using an extended inter-switch link (XISL). Base switches may use XISLs. Dynamically created logical switches can use the XISL for traffic, only if **Allow XISL Use** is enabled through CLI using the configure command.

To select a logical switch, perform the following steps.

1. Use the **Logical Switch** drop-down list to select the fabric ID.

You must have the EGM license installed to view the Logical Switch selection on a Brocade 5100, 5300, or VA-40FC. A dialog box displays asking you to confirm your selection.

2. Click **Yes** to confirm.

The selected logical switch displays.

Viewing logical ports

When base switches are connected through XISLs, a base fabric is formed that includes logical switches in different chassis. A logical link is formed dynamically among logical switches that have the same FID to carry frames between the logical switches. Logical ports are created in the respective switches to support the logical link.

Logical ports are software constructs, and have no corresponding hardware to represent them on the **Switch View**. Logical port information is available in the **Port Admin** tab.

3 Virtual Fabrics overview

1. Select **Port Admin** tab. The **Port Admin** tab displays. Logical ports are displayed in the **FC Ports Explorer** tree structure.
2. To view logical port properties, expand the **Logical Ports** branch, and select a port. The **General** properties are displayed.

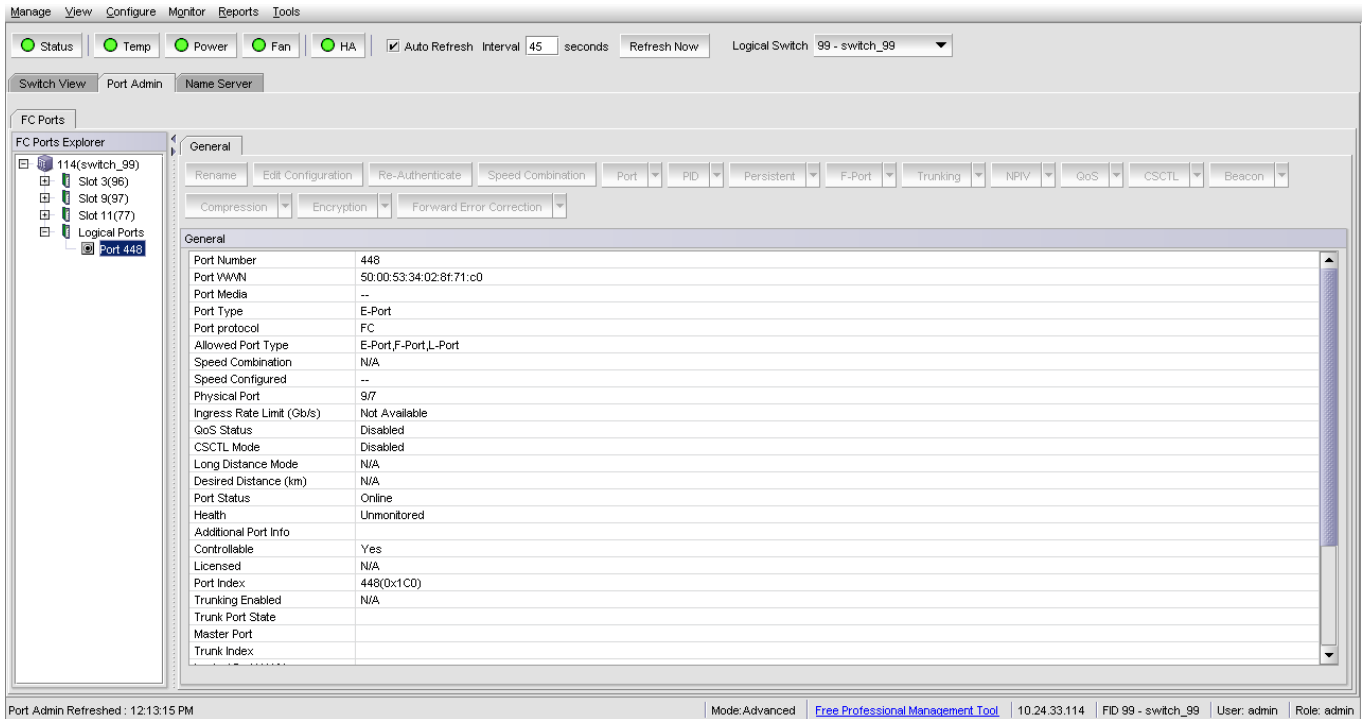

FIGURE 11 Logical ports

Maintaining Configurations and Firmware

In this chapter

- [Creating a configuration backup file](#) 55
- [Restoring a configuration](#) 56
- [Uploading and downloading from USB storage](#) 57
- [Performing a firmware download](#) 57

Creating a configuration backup file

Keep a backup copy of the configuration file in case the configuration is lost or unintentional changes are made. You should keep individual backup files for all switches in the fabric. You should avoid copying configurations from one switch to another.

If you upload from a network, enter the host name or IP address in the **Host Name or IP** field, the user ID and password required for access to the host in the **User Name** and **Password** fields, and select the **Protocol Type** used for the upload. The default is FTP. If you select “Secure Copy Protocol (SCP),” you cannot specify “anonymous” in the **User Name** field.

An [info](#) link is enabled when USB is chosen as the source of the configuration file. If you click on [info](#), the following information message displays ([Figure 12](#)).

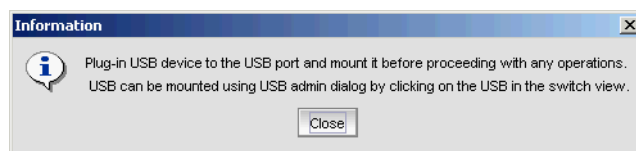

FIGURE 12 Information dialog box

To create a configuration backup file, perform the following task.

1. Select **Configure > Switch Admin**.

The **Switch Administration** window displays.

2. Select **Show Advanced Mode**.
3. Select the **Configure** tab.
4. Select the **Upload/Download** tab.

By default, **Config Upload** is chosen under **Function**, and **Network** is chosen as the source of the configuration file.

5. Enter the configuration file with a fully-qualified path, or select the configuration file name in the **Configuration File Name** field.

4 Restoring a configuration

If you select USB as the configuration file source, the network parameters are not needed and are not displayed. You can skip to step 6.

6. Use the **Fabric ID** selector to select the fabric ID of the logical switch from which the configuration file is to be uploaded.

The selector displays all the virtual fabric IDs that have been defined, the default of 128 for the physical switch, chassis level configuration, and all chassis and switches.

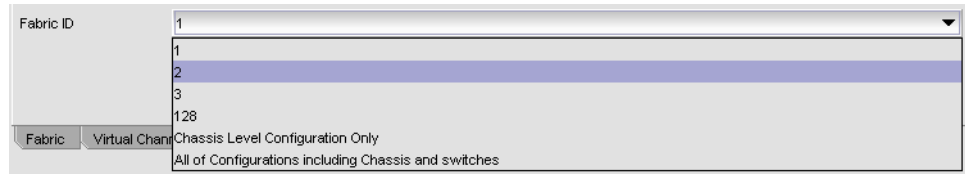

FIGURE 13 Fabric ID selector

NOTE

If you are using a USB device, it must be connected and mounted before you upload or download. Refer to [“Uploading and downloading from USB storage”](#) on page 57 for more information.

7. Click **Apply**.

You can monitor the progress by watching the **Upload/Download Progress** bar.

Restoring a configuration

Restoring a configuration involves overwriting the configuration on the switch by downloading a previously saved backup configuration file. Perform this procedure during a planned down time.

Make sure that the configuration file you are downloading is compatible with your switch model. Configuration files from other model switches might cause your switch to fail.

If you download from a network, enter the host name or IP address in the **Host Name or IP** field, the user ID and password required for access to the host in the **User Name** and **Password** fields, and select the **Protocol Type** used for the upload. The default is FTP. If you select “Secure Copy Protocol (SCP),” you cannot specify “anonymous” in the **User Name** field.

To restore a configuration, perform the following task.

1. Open the **Switch Administration** window.
2. Select **Show Advanced Mode**.
3. Select the **Configure** tab.
4. Select the **Upload/Download** tab.

By default, **Config Upload** is chosen under **Function**, and **Network** is chosen as the source of the configuration file.

5. Under **Function**, select **Config Download to Switch**.

If you select USB as the configuration file source, the network parameters are not needed and are not displayed, and you can skip to step 7.

An **info** link is enabled when USB is chosen as the source of the configuration file. If you click **info**, an information message displays.

6. Enter the configuration file with a fully-qualified path, or select the configuration file in the **Configuration File Name** field.
7. Use the **Fabric ID** selector to select the fabric ID of the logical switch to which the configuration file is to be downloaded.

The selector displays all the virtual fabric IDs that have been defined, the default of 128 for the physical switch, chassis level configuration, and all chassis and switches.

8. Enter the fabric ID of the logical switch in **Template Fabric ID**.

NOTE

If you are using a USB device, it must be connected and mounted before you upload or download. Refer to [“Uploading and downloading from USB storage”](#) on page 57 for more information.

9. Click **Apply**.

You can monitor the progress by watching the **Upload/Download Progress** bar.

Uploading and downloading from USB storage

If you choose to upload or download from a USB device, you must click the USB port to launch the USB Port Management wizard.

To update your USB storage, perform the following steps.

1. Select **Mount USB Device**, and select **Yes** at the confirmation prompt.
2. Right-click on a configuration file to access **Export**, **Copy**, and **Search** options.
3. Click **Copy** to upload and **Export** to download.

Performing a firmware download

During a firmware download, the switch restarts and the browser temporarily loses connection with the switch. When the connection is restored, the version of the software running in the browser is different from the new software version that was installed and activated on the switch. You must close all of the Web Tools windows and log in again to avoid a firmware version mismatch. Note that for chassis-based switches, you might get popup messages that imply the loss of connection is temporary and will soon be resolved. You must still close all windows and re-log in.

When you request a firmware download, the system first checks the file size being downloaded. If the compact flash does not have enough space, Web Tools displays a message and the download does not occur. If this happens, contact your switch support supplier.

To download a new firmware version, perform the following steps.

1. Open the **Switch Administration** window as described in [“Opening the Switch Administration window”](#) on page 31.
2. Select the **Firmware Download** tab.
3. Choose to download either the **Firmware** or the **Firmware key**.

4 Performing a firmware download

The download source can be located on the **Network** or a **USB** device.

NOTE

When you select the **USB** button, you can specify only a firmware path or directory name. No other fields on the tab are available. The **USB** button is available if the USB is present on the switch.

4. Enter the host name or IP address, user name, password, and fully-qualified path to the file *release.plist*.

You can enter the IP address in either IPv4 or IPv6 format.

The path name should use the following structure:

```
//<directory>/<fos_version_directory>/release.plist
```

where the *<directory>* is the path up to the entry point of *<fos_version_directory>* and *<fos_version_directory>* is where the unzipped version of Fabric OS is located.

Example

```
//directory_1/my_directory/v7.0.0/release.plist
```

5. Select the protocol type in the **Protocol Type** field.
If you select “Secure Copy Protocol (SCP),” you cannot specify “anonymous” in the **User** field.
6. Click **Apply**.

The firmware download begins. You can monitor the progress by looking at the **Firmware Download** progress bar.

NOTE

About halfway through the download process, after the firmware key is downloaded to the switch, connection to the switch is lost and Web Tools invalidates the current session. Web Tools invalidates all windows because upfront login is always enabled and cannot be disabled.

7. Close all Web Tools windows and log in again.

If the firmware download is in progress when you log in, you can continue to monitor its progress.

Managing Ports

In this chapter

• Port management overview	59
• Configuring FC ports	64
• Assigning a name to a port	67
• Port beaconing	68
• Enabling and disabling a port	68
• Persistent enabling and disabling ports	69
• Configuring NPIV ports	70
• Port activation	71
• Port swapping index	74
• Configuring BB credits on an F_Port	76
• Configuring ALPA	77
• Configuring port octet speed combination	78
• Configuring CSCTL	80
• Configuring compression and encryption	81
• Forward Error Correction	82
• Inband Management	82
• GigE port modes	84

Port management overview

This chapter describes how to manage FC and gigabit Ethernet (GbE) ports. Refer to [“Viewing EX-Ports”](#) on page 134 for information on how to view and configure EX-Ports.

The **Port Admin** tab is refreshed automatically every sixty seconds and is refreshed immediately when you make any port changes through Web Tools.

To manage ports, you must be logged in with the role of switchadmin, admin, basicswitchadmin, operator, or fabric admin. If you are logged in with a user, securityadmin, or zoneadmin role, you can only view the port information.

For information about creating unique user account roles, refer to [“User-defined accounts”](#) on page 163.

Opening the Port Admin tab

Select **Port Admin** tab in the **Switch Explorer** window. The **Port Admin** tab displays information about the ports on the switch. Refer to “[Switch View](#)” on page 21 for information about accessible ports.

The **Port Admin** tab displays in **Basic** mode. To view more port management options, select **View > Advanced**.

NOTE

You can drag the column divider to resize a column, or drag columns to re-arrange them in a custom order. You can also right-click a column heading to resize one or all columns, or sort the information in ascending or descending order.

Port Admin tab components

The **Port Admin** tab has the following four tabs in the top left corner.

- **FC Ports** tab displays all of the FC ports on the switch (physical FC ports and logical ports).
- **VE/VEx Ports** tab displays all of the VE/VEx ports on the switch. If the switch does not have VE/VEx ports, the **VE/VEx Ports** tab does not display.
- **ICL Ports** tab displays all of the ICL ports on the switch. If the switch does not have **ICL Ports**, the ICL ports tab does not display.
- **GigE Ports** tab displays all of the GigE ports. If the switch does not have GigE ports, the **GigE Ports** tab does not display.

The **GigE Ports** tab has the following subtabs:

- General—General information about the GigE Ports.
- SFP—Displays information about SFP ports.
- Port Statistics—Displays statistics about the ports.
- IP Interfaces—Lets you view interfaces
- IP Routes—Lets you view routes
- Inband IP Interfaces—Lets you configure interfaces
- Inband IP Routes—Lets you configure routes
- FCIP Tunnels—Lets you view FCIP tunnels. This tab has two buttons: **Go to FCIP port** and **Show Security Policies**.

On selecting an FCIP tunnel, the following circuit details with the circuit properties are displayed:

- Circuit Number
- Tunnel ID
- Administrator Status
- Operational Status
- GigEPort
- Source IP
- Gateway
- VLAN ID

- MTU Size
- Compression Mode
- Data L2COS Value
- DSCP Data
- IKE Policy Number
- IPsec Policy Enabled
- Keep Alive Timeout
- MaximumCommunicationRate
- MinimumCommunicationRate
- MaxRetransmitRate
- MinRetransmitRate
- Metric
- Pre-Shared key
- QOS Mapping
- Selective Ack

Ports Explorer tree

The Ports Explorer tree displays on the left side of the window. Items in the tree are displayed as follows:

- Switches—Switch ID, with switch name in parentheses; for example, 3(MapsSW_202)
- Blades—Slot number of the blade, with blade ID in parentheses; for example, Slot 7(24)
- Ports—Port number; for example, Port 2
- 10G SFP ports— A yellow triangle badge displays to visually distinguish the 10G SFP+ ports.

Button area

The button area contains buttons for all the tasks you can perform on the selected port. If you select more than one port, buttons are available for only the tasks that you can perform on all of the selected ports. Buttons are grayed (unavailable) if they are not applicable to the selected ports.

Port information displays in either a table of ports or information about a specific port, depending on your selection. If you select a slot or switch, the system displays a table of all the ports for the slot or switch. If you select a port, the system displays detailed information about the port.

Subtabs

You can view either **Basic Mode** or **Advanced Mode**, and to view the subtabs that contain additional information about the port. The available subtabs depend on the type of port selected.

To view basic mode, select **View > Basic**. When viewing detailed information about a port, **Basic Mode** provides these subtabs:

5 Port management overview

- **General**—All ports
 - View Details
 - Rename
 - Edit Configuration
 - Enable/Disable (port)
 - Persistent Enable/Persistent Disable (port)
- **SFP**—Physical ports only (FC, CEE, and GbE)
 - Basic information about the port equipment
- **QSFP**—Quad Small Form-factor Pluggable ports
 - Basic Information about the port.
 - UnitNumber
 - ChannelIndex
 - DeviceTech

- **Port Statistics**—All ports
 - Basic port information and statistics

Note that on the **Port Statistics** subtab, you can view either absolute values or deltas for port statistics. Viewing the deltas is useful if you want to view current port trends. To reset the counters on the port statistics, click the **Clear Counters** button.

FCIP statistics for a GbE port are the accumulated statistics of all the FCIP tunnels for that GbE port.

- **IP Interfaces**—GbE ports only
- **IP Routes**—GbE ports only

To view advanced mode, select **View > Advanced**. When viewing detailed information about a port, the **Advanced Mode** provides these additional subtabs:

- **General**—All ports
 - Rename
 - Edit Configuration
 - Re-Authenticate
 - Port—Enable/Disable/Swap
 - PID—Bind/Un-Bind
 - Persistent—Enable/Disable
 - F-Port—BB Credit/Trunking
 - Trunking—Enable/Disable
 - NPIV—Enable/Disable/Max Login
 - QoS—Enable/Disable (requires Adaptive Networking License)
 - CSCTL—Enable/Disable (requires Adaptive Networking License)
 - Beacon—Enable/Disable
 - Speed combination (applicable only to the Brocade 6520, Brocade 6510 and Brocade DCX 8510-4,8510-8 with the FC16-32 or FC16-48)
 - Compression—Enable/Disable
 - Encryption—Enable/Disable
 - Forward Error Correction—Enable/Disable
- **SFP**—Physical ports only (FC, CEE, and GbE)
 - Basic Information about the port.
 - Advanced information about the port equipment
- **QSFP**—Quad Small Form-factor Pluggable ports
 - Basic Information about the port.
 - Advanced information about the port equipment.
 - UnitNumber
 - ChannelIndex
 - DeviceTech
 - MaxCaseTemp
- **Port Statistics**
 - Advanced port statistics
 - Error details
 - FCIP Tunnels—GbE ports and logical FCIP ports only (not available for the FR4-16IP).

Controllable ports

All ports have a **Controllable** attribute visible from the **Advanced Mode**, which represents the RBAC permission.

The **Controllable** attribute is **No** when non-owned E_Ports and indirect member ports on non-owned switches are accessible in read-only mode and are not controllable, regardless of RBAC permissions. Additionally, if you are logged in with read-only permission, the **Controllable** attribute displays **No** for all ports.

The **Controllable** attribute is **Yes**, if your role gives you Modify permission for ports. If a port is controllable, all configuration functionality is enabled.

Configuring FC ports

With the **FC Port Configuration** wizard, you can configure allowed port types, port speed, and long distance mode for physical ports.

You must use Web Tools with the EGM license enabled on the switch to configure long distance; otherwise, access to this feature is denied and an error message displays.

The EGM license is required only for 8 Gbps platforms, such as the following:

- Brocade Encryption Switch
- Brocade 300, 5300, and 5100 switches
- Brocade VA-40FC
- Brocade 8000
- Brocade 7800

For non-8 Gbps platforms, all functionality is available without EGM license.

The following procedure describes how to open the **FC Port Configuration** wizard. The wizard is self-explanatory, so the explicit steps are not documented here.

NOTE

With Fabric OS v7.0.1 and later, Web Tools supports interoperability between a Fabric OS fabric and a Brocade Network OS fabric through an FC router. You can select this interoperability mode in the **FC Port Configuration** Wizard.

1. Click a port in the **Switch View** to open the **Port Admin** tab.
2. Select the port you want to configure from the tree on the left.
3. Click the **General** subtab.

NOTE

Long distance does not display from the **General** or **Table** subtabs if the EGM license is not enabled on the switch.

4. Click **Edit Configuration**.

The **FC Port Configuration** wizard displays. The fields are populated with the current configuration values.

NOTE

Long distance is not displayed from the **Edit Configuration** window. You can view long distance from the **View** tab when you display the port details.

5. Follow the steps in the wizard.

NOTE

If you configure a disabled port as an EX-Port, the wizard displays the **Enable Port after configuration** check box. If you select the check box, the disabled port is automatically enabled after configuration; otherwise, the port remains in the same state after configuration.

Allowed port types

For FC ports, the **Port Admin** tab displays the following values relating to port type:

Port Type This is the actual or current port type. If the port is offline, this value is the allowed types (or U_Port, if no type constraint is specified). If the port is online, this value is the type to which the port has been configured.

Allowed Port Type The allowed or configured port type.

The allowed port types indicate any constraints on what types the port can be configured when it comes online. For normal (that is, non-EX-Port) ports, the following are the allowed port types:

L_Port The port can be used to connect a loop device.

F_Port The port can be used to connect a non-loop device.

E_Port The port can be used to connect to another switch. On the Brocade FC8-64, ports 56 through 63 are not available as E_Ports. This option is unavailable for these ports.

U_Port For a physical FC port: the port can be any one of E_Port, F_Port, or L_Port. For a logical FC port: the port can be either VE_Port or VEX-Port.

When the wizard prompts you to select allowed port types, if all of these boxes are selected, there are no constraints on port type. The port negotiated to its preferred type when the switch comes up, depending on what type of device or switch to which it is connected.

Clearing a check box guarantees that the port does not attempt to function as a port of the unchecked type. At least one type must remain selected. An FC port cannot be configured as an E_Port and L_Port.

L_Ports are not supported on the Brocade FC16-32, Brocade FC16-48, Brocade FC8-32E, Brocade FC8-48E, Brocade 6505, Brocade 6510, and Brocade 6520.

NOTE

To configure a port as an EX-Port, the switch must be capable of supporting FCR or FCIP features. The EX-Port option is disabled in the wizard if the switch does not meet these requirements.

Long distance mode

Port long distance configurations can be performed in the **Switch Admin Extended Fabric** tab if the link is used over long distances. To configure the long-distance settings, the EGM license must be enabled on the switch. Otherwise, access to this feature is denied and an error message displays. For information about long-distance mode settings, refer to [Chapter 13, "Administering Extended Fabrics"](#).

The EGM license is required only for 8 Gbps platforms, such as the following:

- Encryption Switch

- 300, 5300, and 5100 switches
- Brocade VA-40FC
- Brocade 8000
- Brocade 7800

For non-8 Gbps platforms, all functionality is available without EGM license.

Ingress rate limit

Ingress rate limiting is a licensed feature that requires the Adaptive Networking license.

NOTE

For Brocade 6520, ingress rate limit can be configured without Adaptive Networking (AN) and Server Application Optimization (SAO) licenses. For other platforms, these licenses are required.

Ingress rate limiting restricts the speed of traffic from a particular device to the switch port, allowing latency-sensitive applications to share the storage resources alongside throughput-intensive applications. Ingress rate limiting delays the return of BB credits to the external device. By limiting the throughput on the ingress side of a port, existing congestion can be removed or avoided.

The implication is as follows:

- Ingress rate limiting is not supported if the F_Port is in AOQ.
- Ingress rate limiting is not supported if the F_Port is part of Trunk.
- Ingress rate limiting is not supported if the F_Port is not QoS enabled, but it connects to a QoS enabled AG switch port.

Ingress rate limiting is applicable only to F_Ports and FL_Ports and is available only on the following platforms:

- Brocade DCX
- Brocade DCX-4S
- Brocade DCX 8510
- Brocade Encryption Switch
- Brocade 300
- Brocade 5100
- Brocade 5300
- Brocade 5410
- Brocade 5424
- Brocade 5450
- Brocade 5460
- Brocade 5470
- Brocade 5480
- Brocade 6510
- Brocade 6520
- Brocade 7800

- Brocade VA-40FC
- Brocade 8000

To configure the ingress rate limit feature, perform the following steps.

1. Select **View > Advanced**.
2. In the **Port Admin** tab, select a port, or multiple ports, to configure.
3. Select **QoS > Enable** option.

This enables the QoS on the selected ports. The selected port QoS status will be displayed in port table.

4. Click the **Edit Configuration** button.

The **Edit Configuration** dialog box displays. This dialog box sets the QoS Ingress Rate Limit on the selected ports.

5. Configure the port using the pre-defined **Ingress Rate Limits**.

NOTE

You can set the Ingress Rate Limit even if QoS is disabled. It does not take effect until QoS is enabled.

Assigning a name to a port

Port names are optional. You can assign a name to an FC or FCIP port to make port grouping easier. You can also rename FC and FCIP ports to new names. You cannot rename GbE ports. The **Port Name** column in the **General** tab displays the default port name.

Port names can be from 1 through 128 alphanumeric characters, unless FICON Management Server (FMS) mode is enabled. If FMS mode is enabled, port names should be limited from 1 through 24 alphanumeric characters. The comma (,), semicolon (;), and “at” symbol (@) are not allowed.

NOTE

Although it is not required, it is recommended that port names be unique.

To assign a name to a port, perform the following steps.

1. Click a port in the **Switch View** to open the **Port Admin** tab.
2. Select the **FC Ports** tab.
3. From the tree on the left, select the switch or slot that contains the port you want to rename.
4. From the table, select the port you want to rename.
5. Click **Rename**.
6. Enter a name for the port and click **Rename**.

Port beaconing

Individual FC ports can be set to beacon using the **Port Admin** tab. Port beaconing status displays in the **Port Beaconing** column. The **Switch View** reflects the port beaconing status by flashing the port amber and green for 2.5 seconds each, in an alternating pattern.

To configure beaconing for an FC port, perform the following steps.

1. Select the **Port Admin** tab.
2. Click **View > Advanced**, if the **Port Admin** tab is in **Basic** mode.
3. Select the switch in the **FC Ports Explorer** list.
4. Select a port from the list in the main window.

The **Beacon** drop-down list becomes active. Select **Enable** or **Disable** from the drop-down list.

NOTE

You may select all the ports on the switch, but if you select a port that is not valid for beaconing, the Port Beacon buttons are disabled.

There is an optional procedure for configuring a single FC port.

1. Select the **Port Admin** tab.
2. Click **View > Advanced**, if the **Port Admin** tab is in **Basic** mode.
3. Select a port from the list in the main window.

The **Beacon** drop-down button becomes active. Select **Enable** or **Disable** from the drop-down button.

Enabling and disabling a port

To enable or disable a port, perform the following steps.

1. Click a port in the **Switch View** to open the **Port Admin** tab.
2. Select the **FC Ports** or **GigE Ports** tab.
3. From the tree on the left, select the switch or slot that contains the port you want to enable or disable.
4. From the table, select one or more ports.

NOTE

Use Shift+click and Ctrl+click to select multiple ports. You can select multiple ports from the table. You cannot select multiple ports from the tree.

5. Select either **Enable** or **Disable** from the **Port** drop-down button.

NOTE

If the Enable or Disable option is gray (unavailable), the port is already in the enabled or disabled state. For example, if the **Enable** option is unavailable, the port is already enabled.

If you select multiple ports in both enabled and disabled states, both options are active. When you click either option, the action is applied to all selected ports.

6. *Optional:* If you are accessing a Brocade 7800 switch, you can set the media type for the GEO and GE1 GigE ports to either copper or optical.
 - a. Select the **GigE Ports** tab.
 - b. Select either the **GEO** or **GE1** port.
 - c. Select either **Copper** or **Optical** from the **Media Type** selection list.
7. Click **Yes** in the confirmation window.

Considerations for enabling or disabling a port

You should understand the following limitations and conditions when enabling or disabling a port:

- On FR4-18i and FC4-16IP port blades, all ports are disabled by default. You can disable and re-enable them as needed.
- If a port is not licensed you cannot enable it until you install the appropriate license, such as a **Ports on Demand** or **N_Port ID Virtualization** license (refer to “[Port activation](#)” on page 71 for more information). The **Licensed** field located in the **General** tab in the **Port Admin** tab indicates whether a port is licensed.
- If you disable a *principal* ISL port (an ISL port that is designated by the fabric to be a part of the path to communicate with the principal switch), the fabric automatically reconfigures.
- If you disable a port that was connected to a device, that device is no longer accessible from the fabric. For more information, refer to *Fabric OS Administrator’s Guide*.

Persistent enabling and disabling ports

To enable or disable a port so that it remains enabled or disabled across switch restarts, perform the following steps.

NOTE

Ports cannot be persistently enabled or disabled when FMS is enabled.

1. Select a port in the **Switch View** to open the **Port Admin** tab.
2. Select the **FC Ports**, **VE/VEx Ports**, **ICL Ports**, or **GigE Ports** tab.
3. From the tree on the left, select the switch or slot that contains the port.
4. From the table, select one or more ports.

NOTE

Use Shift-click and Ctrl-click to select multiple ports. You can select multiple ports from the table. You cannot select multiple ports from the tree.

5. Select either **Enable** or **Disable** from the **Persistent** drop-down button.

NOTE

Persistent **Enable** or **Disable** is not supported in FMS mode.

NOTE

If the Enable or Disable option is gray (unavailable), the port is already in that state or FMS mode is enabled on the switch, the port is already in the enabled or disabled state. For example, if the **Enable** option is unavailable, the port is already enabled.

If you select multiple ports in both enabled and disabled states, both options are active. When you click either option, the action is applied to all selected ports.

6. *Optional:* If you are accessing a Brocade 7800 switch, you can set the media type for the GEO and GE1 GigE ports to either copper or optical.
 - a. Select the **GigE Ports** tab.
 - b. Select either the **GEO** or **GE1** port.
 - c. Select either **Copper** or **Optical** from the **Media Type** selection list.
7. Click **Yes** in the confirmation window.

Configuring NPIV ports

The NPIV license must be installed on a switch before NPIV functionality can be enabled on any port. For detailed information about understanding and configuring NPIV ports, refer to the *Fabric OS Administrator's Guide*.

NOTE

NPIV feature cannot be disabled when Access Gateway mode is enabled.

The **NPIV Max Login Limit** option configures the maximum number of permitted logins per NPIV port. Each NPIV port can support up to 255 logins. The range of valid values is from 1 through 255 logins per port. The default value is 126 logins.

This feature supports virtual switches, but not on physical switches. Each port can have a different NPIV login limit value in each logical switch. The NPIV Max Login column displays the value assigned to each port.

To configure an NPIV port, perform the following steps.

1. Select **Port Admin** tab.
1. Select **View > Advanced**.
2. Select the **FC Ports** tab.
3. From the tree on the left, select the logical port you want to configure.
4. If the NPIV port is not already disabled, select **Disable** from the **NPIV** drop-down button.

The NPIV login limit for a port can be set only for disabled ports.

5. Select **Max Login** from the **NPIV** drop-down button.

The **Configure NPIV Max Login** dialog box displays. You can configure only one port at a time.

6. Set the number of logins to allow on the selected port and click **OK**.
7. Click **Enable** to bring the port back online.

Port activation

Brocade switches come with a preset number of ports enabled. Additional ports can be enabled using the Ports on Demand (POD) licenses and the Dynamic Ports on Demand (DPOD) feature (for supported switches only).

Ports on Demand is ready to be unlocked in the switch firmware. The license might be part of the licensed Paper Pack supplied with the switch software, or you can purchase the license separately from your switch vendor, who will provide you with a key to unlock it. You can install up to two Ports on Demand licenses on each switch.

[Table 9](#) lists the ports that are enabled by default settings and the ports that can be enabled after you install the first and second Ports on Demand licenses for each switch type, and the ports that can be enabled with the Dynamic PODs feature.

TABLE 9 Ports enabled with POD licenses and DPOD feature

Switch name	Enabled by default	Enabled with Ports on Demand licenses	Enabled with the Dynamic Ports on Demand feature
Brocade Encryption	0-15	Not supported	Not supported
Brocade 8000	None	0-7	Not supported
Brocade 6505	0-11	12-23	
Brocade 6510	0-23	24-35, 36-47	
Brocade 6520	0-47	48-71, 72-95	
Brocade VA-40FC	0-23	24-31, 32-39	Not supported
Brocade NC-5480	1-8, 17-20	0, 9-16, 21-23	
Brocade 5480	1-8, 17-20	0, 9-12, 13-16, 21-23	Any available ports
Brocade 5470	0-7, 15, 16	8-14, 17-19	
Brocade 5460	0-3, 6-13	4, 5, 14-25	
Brocade 5450	1-10, 19-22	0, 11-18, 23-25	
Brocade 5424	1-8, 17-20	0, 9-16, 21-23	Any available ports
Brocade 5300	0-47	48-63, 64-79	Not supported
Brocade 5100	0-23	24-31, 32-39	Not supported
Brocade 5000 Brocade 4100	0-15	16-23, 24-31	Not supported
Brocade 4900	0-31	32-47, 48-63	Not supported
Brocade 4424	1-8, 17-20	0, 9-16, 21-23	
Brocade 4024	1-8, 17-20	9-12, 13-16, 21-23	Any available ports
Brocade 4020	0-7, 15, 16	8, 9, 17-19, 10-14	Any available ports
Brocade 4018	0-11	12-17	Any available ports

TABLE 9 Ports enabled with POD licenses and DPOD feature (Continued)

Switch name	Enabled by default	Enabled with Ports on Demand licenses	Enabled with the Dynamic Ports on Demand feature
Brocade 4016	0-7, 10-13	8, 9, 14, 15	Any available ports
Brocade 300	0-7	8-15, 16-23	Not supported

When using the Brocade 4016, 4018, 4020, 4024, 4424, 5424, 5450, 5460, 5470, 5480, 6505, 6510, 6520, and NC-5480 switches, you can enable the Dynamic Ports on Demand (DPOD) feature, which allows you to select the ports to be enabled (instead of predefined sets of ports) after the POD license is installed. Web Tools allows you only to enable or disable the DPOD functionality on a port. To configure DPOD, refer to the *Fabric OS Administrator's Guide*.

In the **Port Admin** tab, the **Licensed** attribute indicates whether a port is licensed (yes), whether it can be licensed (possible) because there are free licenses available (only applicable with the Dynamic POD feature), or whether it is not licensed and cannot be licensed because there is no available license.

After the license keys are installed, you must enable the ports. You can do so without disrupting switch operation, as described in [“Enabling and disabling a port”](#) on page 68. Alternatively, you can disable and re-enable the switch to activate all ports as described in [“Enabling and disabling a switch”](#) on page 35.

To unlock a Ports on Demand license, you can use the supplied license key or generate a license key. If you need to generate a key, open an Internet browser and go to the Brocade website at www.brocade.com. Select **Products > Software License Keys** and follow the instructions to generate the key.

Enabling Ports on Demand

To enable Ports on Demand, perform the following steps.

1. Install the Brocade Ports on Demand licensed product. For instructions, refer to [“Activating a license on a switch”](#) on page 43.
2. Enable the ports as described in [“Enabling and disabling a port”](#) on page 68.

If you remove a Ports on Demand license, the licensed ports are disabled after the next platform restart or the next port deactivation.

Enabling Dynamic Ports on Demand

You must be logged in as Admin to enable the Dynamic POD feature.

NOTE

The Dynamic PODs feature is supported on the Brocade 4018, 4020, 4024, 5460, and 5470 switches only. If you click the **Enable DPOD** button on an unsupported switch, an error message displays.

To enable Dynamic Ports on Demand, perform the following steps.

1. Select a port in the **Switch View** to open the **Port Admin** tab.
2. Select the **FC Ports** tab.
3. From the tree on the left, select the switch or the slot that contains the port.

4. Click **Enable DPOD** to enable the licensing mechanism to be dynamic. If the button is labeled **Disable DPOD**, the licensing mechanism is already set to dynamic.

The existing POD associations and assignments are set as the initial Dynamic POD associations.

Two fields are displayed:

- **Available Licenses** indicate the number of free licenses. These can be allocated for any port.
- **Total Licenses** indicate the total number of licenses.

Disabling Dynamic Ports on Demand

NOTE

Disabling DPODs causes traffic disruption. Any prior port associations and assignments are lost the next time the switch is restarted.

To disable the Dynamic POD feature, log in and perform the following steps.

1. Select a port in the **Switch View** to open the **Port Admin** tab.
2. Select the **FC Ports** or **GigE Ports** tab.
3. From the tree on the left, select the switch or the slot that contains the port.
4. Click **Disable DPOD** to set the licensing mechanism to static. If the button is labeled **Enable DPOD**, the licensing mechanism is already set to static.

Diagnostic ports

Diagnostic ports (D_Port) are used for running diagnostics to isolate link level faults and inter-switch link testing in fabric, optical and remote loopback modes. D_Ports are not part of any fabric and it does not carry any data or protocol traffic with it. It is used only for running diagnostic traffic for isolating link level faults. D_Port can be used to get estimated link distance measure as done for long distance mode links. For information on configuring a D_Port, see the *Fabric OS Administrator's Guide*. Web Tools can not configure a D_Port.

Following list of features are not supported when a port is configured as a D_Port.

- Port swap
- Port bind
- Port trunk
- QOS Enable/Disable
- BB credit
- NPIV Enable/Disable/Max login
- Allow/Prohibit Matrix

D_Ports do not take part in zoning. If D_Port is added to a zone it does not take part in the fabric.

Reserving and releasing licenses on a port basis

NOTE

The Dynamic PODs feature is supported on the Brocade 4018, 4020, and 4024 switches only.

To reserve and release licenses on a port basis, perform the following steps.

1. Click a port in the **Switch View** to open the **Port Admin** tab.
2. Click the **FC Ports** tab.
3. From the tree on the left, click the switch or the slot that contains the port.

The **Licensed** column identifies the port license status:

- If the port has a license allocated, the **Licensed** field contains the value **Yes**.
- If the port does not have a license allocated and there are no free licenses that can be allocated, the **Licensed** field contains the value **No**.
- If the port does not have a license allocated and there are licenses that can be allocated to the port, the **Licensed** field contains the value **Possible**.

You can reserve or release a license on any port with a license allocated. You must be logged in as Admin to reserve and release licenses.

NOTE

You must disable the port or switch before reserving or releasing a license.

To reserve a license, click **Reserve License** in the **Port Admin** tab.

To release a license, click **Release License** in the **Port Admin** tab.

Port swapping index

If a port malfunctions, or if you want to connect to different devices without having to rewire your infrastructure, you can move traffic from one port to another (*swap ports*) without changing the I/O Configuration Data Set (IOCDs) on the mainframe computer.

NOTE

Port swapping is not applicable to GE or ICL ports because there are no areas assigned to these ports.

The following restrictions apply to all ports:

- Ports can be swapped only once.
- A swapped port can only be un-swapped.
- Port binding is not supported on swapped ports.
- The swapped ports cannot be moved to other logical switches.
- The logical switch addressing mode cannot be changed if the logical switch contains the swapped ports.

Port swapping

In the Port Admin list view and detailed view, swapped ports are indicated with the “(Swapped)” label appended to the **Port Index** column and field (Figure 14).

Port#	Port Index
0(0x0)	0(0x0)
1(0x1)	4(0x4) (Swapped)
2(0x2)	3(0x3) (Swapped)
3(0x3)	2(0x2) (Swapped)
4(0x4)	1(0x1) (Swapped)
5(0x5)	7(0x7) (Swapped)
6(0x6)	6(0x6)

FIGURE 14 Port swapped label

To swap ports, perform the following steps.

1. Select a port in the **Switch View** to open the **Port Admin** tab.
2. Select the **FC Ports** tab.
3. Select **View > Advanced**.
4. From the tree on the left, select the port you want to swap.
5. Select **Disable** from the **Port** drop-down button.

You must disable the ports used for port swapping. If the port is not in the disable state, the port swap operation internally disables and re-enables the port.

6. Select **Swap** from the **Port** drop-down button.

NOTE

When the **Port Swap** dialog box is launched for a swapped port, the dialog box displays “The Selected port is already Swapped”

7. Enter the number of the port with which you want to swap the current port.
If the port is on a blade, you must also provide the slot number.

NOTE

Port swap is not supported above the 16th port in a 48 port card in FMS mode.

8. Click **Ok**.

Determining if a port index was swapped with another switch port

To determine whether a port was swapped, perform the following steps.

5 Configuring BB credits on an F_Port

1. Select a port in the **Switch View** to open the **Port Admin** tab.
2. Select the **FC Ports** tab.
3. Select **View > Advanced**.
4. From the tree on the left, select the port you want to swap.
5. Click the **General** tab.

NOTE

The **Port Index** attribute on the **General** tab indicates whether a port was swapped. For ports that were swapped, the attribute name displays as *Port Index (Swapped)*, as shown in [Figure 15](#). The value indicates with which port index the port was swapped.

General	
Port Number	4(0x4)
Port Name	
Port WWN	20:04:00:05:1e:38:49:54
Port Media	--
Port Type	U-Port
Port protocol	FC
Allowed Port Type	E-Port,F-Port,L-Port
Speed (Gb/s)	N4
Speed Configured	Auto-Negotiate
Ingress Rate Limit (Gb/s)	Not Available
QOS Status	Enabled
Long Distance Mode	L0:Normal
Desired Distance (km)	N/A
Port Status	No_Module
Controllable	Yes
Licensed	Yes
Health	Offline
Port Index(Swapped)	10(0xA)
Trunking Enabled	true
FC Fast Write Enabled	false
Trunk Port State	
Master Port	

FIGURE 15 Port swapping index

Configuring BB credits on an F_Port

In Fabric OS v6.4.0 and later, you can configure the BB credits value on an F_Port. Follow the steps given below.

1. Select a port in the **Switch View** to open the **Port Admin** tab.
2. Select the **FC Ports** tab.
3. Select **View > Advanced**.
4. Select **BB Credit** from the **F-Port** drop-down button.
5. Enter the BB credit value in the **Enter BB Credit** field (the default value is 8).

NOTE

You cannot modify the default BB credit value for VE and ICL ports.

6. Click **OK**.

The value displays in the table of the **Port Admin** tab. If no value is configured, the **F-Port BB Credit** column displays the default value.

Configuring ALPA

PID is the address assigned to the host when it performs a login with a fabric. The 24 bits of the PID are built from three 1 byte fields. The most significant byte is the Domain ID, the second byte is the Area which that device belongs to, and the least significant byte is the ALPA.

Persistent ALPA provides the hosts with the same ALPA which they received the first time they logged in. If they login using the same port, the domain and the area for that device are still the same. This ensures that whenever a host logs in using the same port, it receives the same PID. The hosts can select their ALPA and the switch provides the same value, if it's available.

By default, persistent ALPA is disabled on Access Gateway switches. Access Gateway always tries to request the same ALPA which the host has requested to the edge switch, but there is a possibility that the ALPA value has already been taken by another host. Therefore, the device can either use a different ALPA value (FLEXIBLE ALPA) which is available or can stick to the same requested ALPA value (STRINGENT ALPA). As the Access Gateway controls the assignment of ALPA values to the devices, it knows which ALPA value has been taken and which is free. With FLEXIBLE ALPA option, the host login is accepted with either the requested ALPA value or a different ALPA value. With STRINGENT ALPA, if the requested ALPA value is not available, the login is rejected.

The Enable/Disable of Persistent ALPA feature is available on the **Switch** tab of the **Switch Admin** dialog box. The Persistent ALPA tables start populating as soon as the Access Gateway boots and the devices start logging in.

NOTE

Persistent ALPA is supported on all the Access Gateway platforms, except the Brocade Encryption Switch. Persistent ALPA is not supported in non-Brocade fabric and the Brocade 8000.

To configure Persistent ALPA, perform the following steps.

1. Select **Configure > Switch Admin > Switch** tab.
2. Select the **enable** radio option of Persistent ALPA.

After selecting **enable**, the **stringent** and **flexible** radio buttons are enabled. Neither radio buttons are selected by default.
3. Select either **stringent** or **flexible**.
4. Click **Apply**.
5. Close the **Switch** page.
6. Select **Port Admin**.
7. Select an F_Port or U_Port from the device tree or Port List table.
8. Click **ALPA Map**.

5 Configuring port octet speed combination

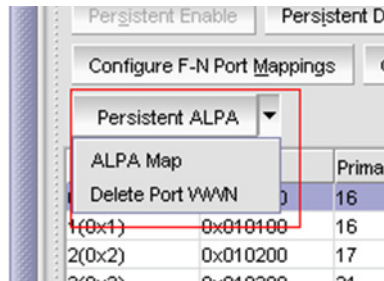

FIGURE 16 ALPA Map selection

A dialog box launches listing the Port WWN to ALPA Map with the host. The Port WWN map automatically populates.

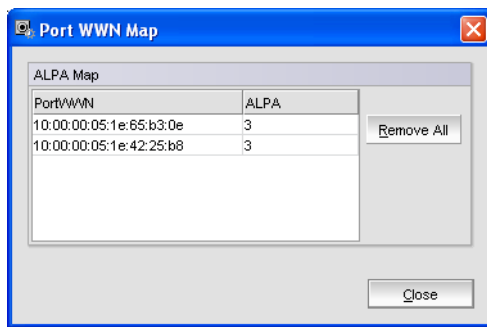

FIGURE 17 ALPA Map dialog

9. *Optional:* Click **Remove All** to clear all of the Port WWN maps.

Configuring port octet speed combination

The **Port Admin** tab provides an option to set the Port Octet Speed Combination. This option is available only on the following platforms:

- Brocade DCX 8510-8 and DCX 8510-4 with the FC8-32E, FC8-48E, FC16-32, and FC16-48 port blades
- Brocade 6510
- Brocade 6520

The ports on these hardware models are segregated into 8 port octets. The Port Octet Speed Combination is applied to the eight ports to which the selected port belongs. Based on this Port Octet Speed combination, the speed options will be available in the Edit Configuration Dialog.

TABLE 10 Port octet speed combinations

Port Octet in Combination	Available port speeds within the Octet
1	Auto or Fixed 16G 8G 4G 2G
2	ASN or Fixed 10G 8G 4G 2G
3	Auto or Fixed 16G 10G

NOTE

For FC8-32E and FC8-48E port blades, the port octet speed combination is **Auto or Fixed 8G|4G|2G**.

You can change the octet combination for the octet associated with first eight ports of a blade or switch. The first eight ports are based on the slot port number (or user port number in case of the Brocade 6510 or Brocade 6520). The octet speed must be set consistently across all members of the port octet.

NOTE

Changing from one combination to another is disruptive operation. It may cause connected ports to become No_Sync. The 10 GE license is required in order to set a port to speed 10G.

To configure the Port Octet Speed Combination, perform the following steps.

1. Select the **Port Admin** tab.
2. Select **View > Advanced** mode.
3. Select the **FC Ports** tab.
4. In the **FC Ports Explorer**, select a port to configure.

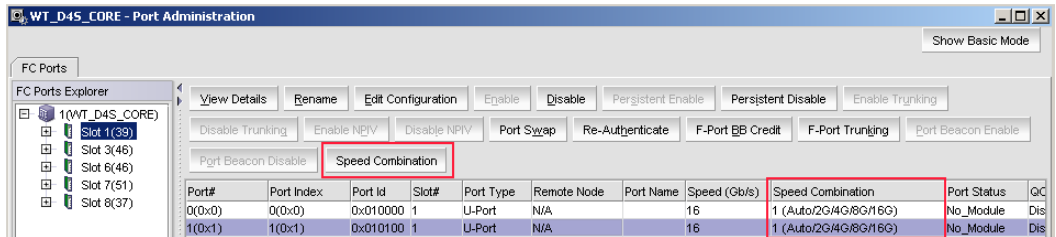

FIGURE 18 FC Explorer dialog

5. Click **Speed Combination**.

The **Port Octet Speed Combination** dialog displays.

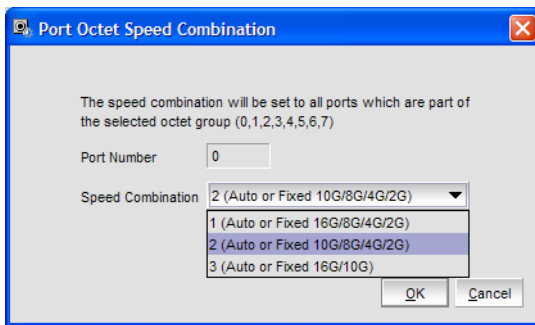

FIGURE 19 Port Octet Speed Combination dialog

6. Select a **Speed Combination** and click **OK**.

Configuring CSCTL

Unlike QoS Zone-based FC flow prioritization method, CSCTL enables the same SID/DID pair exchange frames with different priorities.

To be able to prioritize a frame flow between two end nodes, Fabric OS v7.0.0 and later provide support for up to 32 Virtual Channels (VCs) per port. This categorizes the frames entering into a fabric on the basis of preset behavior defined with these VCs, and conserves the frame's behavior until it is transmitted out of fabric. However, out of the 32 VCs for each external port, only 16 are used.

With the CSCTL method of prioritization, there is no need to have explicit traffic segregation, such as QOS_H, QOS_M and QOS_L. The classification is entirely based upon CSCTL database programmed into the ASIC. As the name suggests, CSCTL bits in each frame are used to define the VC number on the transmit port.

In order to achieve this kind of classification, Fabric OS v7.0.0 and later provides a CSCTL database table on each chip, capable of storing 256 entries. Each entry in the database table is populated with a VC number which, if this feature is enabled, is retrieved by indexing the CSCTL value into the table for each frame entering the fabric.

Irrespective of the type of frame classification method used, the flow priority of a frame is primarily determined by the VC number used to transmit the frames across the ISL ports. In both methods of classification, the VC number for a frame is determined at the ingress Fabric port or Fabric Loop port (F/FL), when the frame enters the fabric for the very first time. To maintain the same flow priority for a frame across all the ISL hops in a fabric, the same VC number is used while transmitting the frame at the egress E_Port until it is out of the fabric thru a F/FL port. The main difference between QoS Zone method of classification and CSCTL VC based method of classification is how the VC number is computed when the frame enters into the fabric thru an F/FL port and, of course, the manner of setting up these two frame classification methods.

Once the CSCTL mode is enabled on an F/FL port in a switch, the CSCTL value in the frame header of all the incoming frames on that F/FL port are used to index into the ASIC's CSCTL database table to compute the VC number, which will define the frame's flow priority throughout its life in the fabric until it exits out of the fabric thru another F/FL port. The QoS links (ISLs) preserve this classification during frame's traversal across all the hops in the fabric.

NOTE

When CSCTL mode and QoS zones are enabled, QoS zones lose priority to CSCTL mode.

To enable CSCTL mode, perform the following steps.

1. Select the **Port Admin** tab.
2. Select **View > Advanced** mode.
3. Select the F_Ports to configure.
4. Select **Enable** from the **CSCTL** drop-down button.

To disable CSCTL mode, perform the following steps.

1. Select the **Port Admin** tab.
2. Select **View > Advanced** mode.
3. Select the F_Ports to configure.

4. Select **Disable** from the **CSCTL** drop-down button.

Configuring compression and encryption

Encryption provides security for the frames while they are in-flight and Compression allows better bandwidth utilization over long distance. Total bandwidth supported per blade for encryption is 32 Gbps and compression is 64 Gbps. For a pizza box switch, total bandwidth for encryption and/or compression is 32 Gbps.

NOTE

This feature is supported only on 16 Gbps capable FC platforms and it is not supported in Access Gateway mode.

Enabling/disabling encryption

To configure encryption for an FC port, perform the following steps.

1. Click **Configure > Switch Admin**.
2. Select **Security Policies** tab and then **Authentication** from the left panel.
3. Select **Active** or **On** from the **Switch Authentication Policy Mode** drop-down list.

NOTE: For enabling or disabling encryption on a port, the following criteria must be satisfied.

- The switch authentication policy should be active or on.
 - **DH Group** must be set to **0, 1, 2, 3, 4** or **4 (2048 bit key)**.
4. Click **Apply** and **Close**.
 5. Select **Port Admin** tab from the Switch Explorer window.
 6. Select **View > Advanced**.
 7. Select a port from the **FC Ports Explorer**.
 8. Select **Enable** or **Disable** from the **Encryption** drop-down button.

Either of the following encryption status is displayed in the **General** tab of the port.

- **Enabled (Active)** - Encryption is enabled on a port and the configuration is Active.
- **Enabled (Inactive)** - Encryption is enabled on a port and the configuration is Inactive.
- **Disabled** - Encryption is not enabled on a port.

Enabling/disabling compression

To configure compression for an FC port, perform the following steps.

1. Select **Port Admin** tab from the Switch Explorer window.
2. Select **View > Advanced**.
3. Select a port from the **FC Ports Explorer**.
4. Select **Enable** or **Disable** from the **Compression** drop-down button.

Either of the following compression status is displayed in the **General** tab of the port.

- **Enabled (Active)** - Compression is enabled on a port and the configuration is Active.
- **Enabled (Inactive)** - Compression is enabled on a port and the configuration is Inactive.
- **Disabled** - Compression is not enabled on a port.

Displaying compression ratio

16 Gbps capable FC platforms that support compression and encryption, also provide the compression ratio. Under **Port Admin** tab, the **FC Ports** tab and the **General** tab of a port display one of the following values for the **Compression Ratio**:

<<numeric value>>	Compression is enabled for a port.
--	Compression is supported but not configured.
N/A	Compression is not supported.

Forward Error Correction

Forward Error Correction (FEC) allows recovering of error bits in a 10Gbps or a 16Gbps data stream. This feature is enabled by default on all ISLs and ICLs of 10Gbps and 16Gbps FC platforms. Forward error correction is supported in Access Gateway mode.

To configure forward error correction for an FC port or ICL port, perform the following steps.

1. Select **Port Admin** tab from the Switch Explorer window.
2. Select **View > Advanced**.
3. Select a port from the **FC Ports Explorer** or **ICL Ports Explorer**.
4. Select **Enable** or **Disable** from the **Forward Error Correction** drop-down button.

Either of the following forward error correction status is displayed in the **General** tab of the FC port or ICL port.

- **Enabled (Active)** - FEC is enabled on a port and the configuration is Active.
- **Enabled (Inactive)** - FEC is enabled on a port and the configuration is Inactive.
- **Disabled** - FEC is not enabled on a port.
- **NA** - FEC is not supported.

Inband Management

Inband Management is designed to allow the management of the switch through GigE ports. This allows a management station located on the WAN side of the FCIP platform to communicate with the control processor for management tasks, such as launching Web Tools, SNMP polling, SNMP traps, trouble shooting, and configuration. To provide this communication, new interfaces have been added to the control processor that have an external IP address, allowing IP connectivity through the port processor to the control processor.

The Inband Management interface is protocol independent, so any traffic destined for these Inband Management interfaces is passed through the distribution point to the control processor. It is then handled on the control processor, according to the rules set forth for the normal management interface and following any security rules that may be in place on the control processor.

To provide redundancy, there is one inband management interface per GigE port. This allows the management station on the WAN side of the network to have multiple addresses with which to reach that switch, and allow redundancy in the event one of the GigE ports becomes unreachable for any reason.

Communication is handled through external addresses that are configured independently for each Inband Management interface. The Inband Management interfaces share the routing table on the control processor. This is separate from the routing table for each GigE port that exists. Because of this there are certain limits to the addresses that are allowed, and the routes that are allowed for the Inband Management interfaces and route entries.

Inband Management is supported on the Brocade 7800 and Brocade FX8-24. Only one IP interface entry can be configured per GigE port.

To configure Inband Management, perform the following steps.

1. Select **Port Admin > GigE Ports > Inband IP Interface**.
2. Click **Add** to configure a new Inband Management entry.
3. Set the **IP Address Type** to **IPv4**.
4. Set the address options:
 - IP Address
 - Subnet Mask
 - MTU Size
5. Click **OK**.
6. Select the **Inband IP Routes** tab.
7. Click **Add** to configure a new route entry.

You can create a maximum of 32 Inband IP Route entries.
8. Set the **IP Address Type** to either **IPv4**.
9. Set the address options of the management station on the WAN side of the FCIP platform:
 - Destination IP Address
 - Subnet Mask
 - Gateway IP Address
10. Click **OK**.
11. Select the **General** sub-tab.
12. Select the **Enable** option from the **Inband** selection list to activate Inband Management.

GigE port modes

Web Tools allows you to set the GigE port mode for the FX8-24 DCX Extension Blades to 1G, 10G, or dual modes.

To configure the GigE port mode, perform the following steps:

NOTE

You must install the FX8-24 DCX Extension Blade in a slot containing 10GE license to configure the mode.

1. Select **Port Admin > GigE Ports**.
2. Select **View > Advanced**.
3. Select a slot from the **GigE Ports Explorer** panel.
The **Mode** drop-down button gets enabled.
4. Select one of the following modes from the **Mode** drop-down button.
 - **1G** - To enable ge0 through ge9 ports.
 - **10G** - To enable xge0 and xge1 ports.
 - **Dual** - To enable ge0 through ge09 and xge0 ports.
5. Click **Yes** on the confirmation dialog box.

Enabling ISL Trunking

In this chapter

- [ISL Trunking overview](#) 85
- [Disabling or enabling ISL Trunking](#)..... 85
- [Viewing trunk group information](#) 86
- [F_Port trunk groups](#)..... 87

ISL Trunking overview

Inter-Switch Link (ISL) Trunking optimizes network performance by forming trunking groups that can distribute traffic between switches across a shared bandwidth.

A trunking license is required on each switch that participates in the trunk. For details on obtaining and installing licensed features, refer to [“Licensed feature management”](#) on page 43. For additional information about ISL Trunking, refer to the *Fabric OS Administrator’s Guide*.

You must use Web Tools with the EGM license to create ISL trunk groups and to manage F_Port trunks.

The EGM license is required only for 8 Gbps platforms, such as the following:

- Brocade Encryption Switch
- Brocade 300, 5300, and 5100 switches
- Brocade VA-40FC
- Brocade 8000
- Brocade 7800

For non-8 Gbps platforms, all functionality is available without EGM license.

For detailed information about ISL Trunking configurations and criteria, refer to the *Fabric OS Administrator’s Guide*.

Disabling or enabling ISL Trunking

The trunking feature requires using Web Tools with the EGM license. If you attempt to use this feature without the EGM license, an error message displays.

When the trunking license is activated, trunks are automatically established on eligible ISLs and trunking capability is enabled by default on all ports. Trunking is not supported on logical ports or GbE ports.

To disable trunking on a port, or to re-enable trunking if it has been disabled, perform the following steps.

6 Viewing trunk group information

1. Select a port in the **Switch View** to open the **Port Admin** tab.
2. Select the **FC Ports** tab.
3. From the tree on the left, select the switch name or slot name.
4. From the table, select the port that you want to trunk.

You can select multiple ports from the table. You cannot select multiple ports from the tree.

5. Select **View > Advanced**.

Click either the **Enable** or **Disable** option from the **Trunking** drop-down button.

If the option is unavailable, then the selected port is already in that state.

6. Click **Yes** in the confirmation dialog box.

Viewing trunk group information

Use the **Trunking** tab on the **Switch Administration** window to view trunk group information.

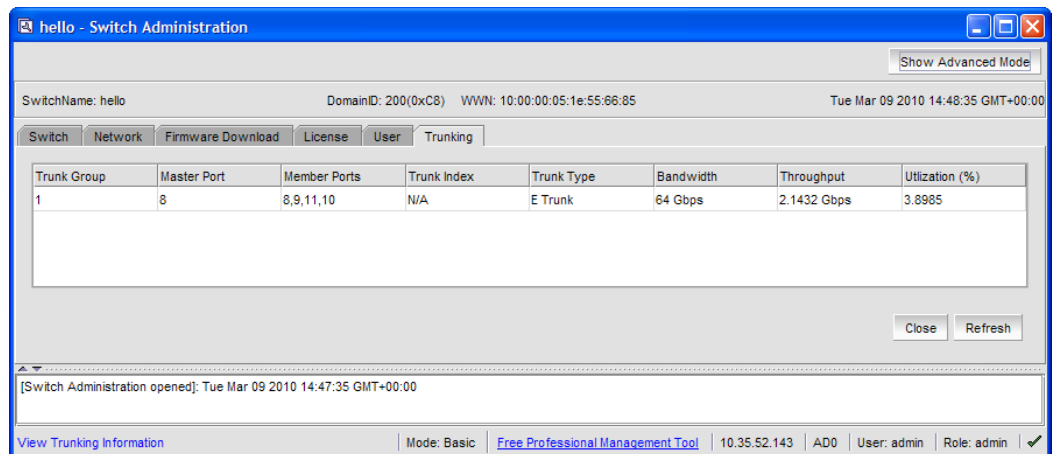

FIGURE 20 Trunking tab

The following trunking attributes can be displayed from the **Switch Admin** view:

- Trunk port state, either master or slave.
- Trunk master port
- Trunk index (applies only to F_Port trunking).
- Trunk type
- Bandwidth (shown only for E_Port, EX-Port, F_Port, and N_Port).
- Throughput (shown only for E_Port, EX-Port, F_Port, and N_Port).
- Utilization (shown only for E_Port, EX-Port, F_Port, and N_Port).

Additionally, the following trunking attributes can also be displayed from the **Port Admin** tab in **Advanced** mode:

- Trunk port state, either master or slave.
- Master Port

- Trunk Index (applies only to F_Port trunking).
- Trunking Enabled

F_Port trunk groups

F_Port trunking provides extra bandwidth and robust connectivity for hosts and targets connected by switches in Access Gateway mode. There are five general criteria for establishing F_Port trunking:

- The F_Port trunking feature requires installing the EGM license; otherwise if you attempt to use this feature in Web Tools without the license, an error message displays.
- Trunking must be enabled on the ports.
- The trunking license must be enabled on the switch in Access Gateway mode.
- The ports should not be configured for long distance connections.
- The ports should not be port-swapped.

When you create an F_Port trunk you create a logical entity called a trunk index (TI), which represents the physical ports. The TI represents all ports in the trunk. If a master port fails, and a slave port takes over, the TI remains the same.

The EGM license is required only for 8 Gbps platforms, such as the following:

- Brocade Encryption Switch
- Brocade 300, 5300, and 5100 switches
- Brocade VA-40FC
- Brocade 8000
- Brocade 7800

For non-8 Gbps platforms, all functionality is available without EGM license.

Creating and maintaining F_Port trunk groups

The FS8 -18 Encryption blade provides trunk groups with a maximum of eight ports per trunk group. The trunk groups are in the blade port ranges 0-7 and 8-15, which are applicable to front end ports. On the Brocade Encryption Switch, the trunk groups are in the port ranges 0-7, 8-15, 16-23, and 24-31, which are applicable on the front end ports.

User this procedure to create an F_Port trunk group, and to add or remove member ports.

1. Select **Port Admin** tab.
2. Select **View > Advanced**.
3. Select any port from the port group in which you want to create the trunk group.
4. Select **Trunking** from the **F_Port** drop-down button.

The **F_Port Trunking** dialog box displays.

5. Select one or more ports in the **Ports for trunking** pane.
A dialog box displays, asking you to select a trunk index.
6. Select the trunk index from the drop-down list populated with the index for all the ports.

6 F_Port trunk groups

A trunk group is created, identified by the trunk index, and containing the port you selected.

7. Select the trunk group you just created.

Add Members becomes active.

8. Additional ports can be added by selecting a port from **Ports for trunking** table and then clicking **Add Members**.

NOTE

To remove a port from the trunk group, select the port from **Trunk Groups** table and then click **Remove Members**.

9. Click **OK** to save your changes.

Monitoring Performance

In this chapter

- Performance Monitor overview 89
- Opening the Performance Monitor window 94
- Creating basic performance monitor graphs 94
- Customizing basic monitoring graphs 95
- Advanced performance monitoring graphs 97
- Tunnel and TCP performance monitoring graphs 99
- Saving graphs to a canvas 100
- Adding graphs to an existing canvas 101
- Printing graphs 101
- Modifying graphs 101

Performance Monitor overview

The Web Tools Performance Monitoring tool graphically displays throughput (in megabytes per second) for each port and for the entire switch. To utilize performance monitoring, the EGM license must be enabled on the switch. Otherwise, when you select **Monitor > Performance Monitor**, access to this feature is denied and an error messages displays

Basic monitoring

The **Basic Monitoring** menu is standard in the Web Tools software. Any user logged into Web Tools with an associated role of zoneadmin or securityadmin cannot open **Performance Monitor**. The roles user, operator, basicswitchadmin, and properly configured user defined roles are allowed to perform basic monitoring tasks. Only users with the admin, switchadmin and fabricadmin roles associated with their login accounts are able to save or display a canvas. Use the **Basic Monitoring** option in the **Performance Graphs** window to do the following:

- Create user-definable reports.
- Display a performance canvas for application-level or fabric-level views.
- Save persistent graphs across restarts (saves parameter data across restarts).

Advanced monitoring

The **Advanced Monitoring** menu is an optionally licensed feature. To utilize the **Advanced Monitoring** feature you must have a Performance Monitor license installed and you must log in using an account with an admin, switchadmin, fabricadmin role, and properly configured user defined roles.

The **Advanced Monitoring** option in the **Performance Graphs** window displays predefined reports and filter-based performance monitoring. You can use this feature to track the following:

- The number of words received and transmitted in Fibre Channel frames with a defined SID/DID pair.
- The number of times a particular filter pattern in a frame is transmitted by a port.

For detailed information on performance monitoring, refer to the *Fabric OS Administrator's Guide*.

Performance graphs

Each performance graph is displayed individually in a window, so it can be minimized, maximized, resized, and closed.

Graphs within the **Performance Monitor** window are updated every 30 seconds. When you first display the graph or if you modify the graph (such as to add additional ports), you might have to wait up to 30 seconds before the new values are shown.

When you have multiple graphs open in the **Performance Monitor** window, you can perform the following tasks:

- Select **Window > Tile** to view all graphs at once, tiled in the **Performance Monitor** window.
- Select **Window > Cascade** to view one graph at a time.
- Select **Window > Close All** to close all open Performance Monitor graphs in the **Performance Monitor** window.

In addition, the **Window** menu lists all open graphs. You can click **Window**, and then select a graph name to view that graph.

The **Tunnel and TCP Graph** option in the **Performance Graphs** window displays real time performance monitoring charts for Brocade 7800 Extension Switch and FX8-24 DCX Extension Blade. This option is not available on other platforms.

Predefined performance graphs

Web Tools predefines basic graph types to simplify performance monitoring. A wide range of end-to-end fabric, LUN, device, and port metrics graphs are included.

[Table 11](#) lists the basic monitoring graphs available. [Table 12](#) lists the advanced monitoring graphs.

The advanced monitoring graphs give more detailed performance information to help you manage your fabric. You can access the basic monitoring graphs on all switches; advanced monitoring graphs are available only on switches that have a Brocade Advanced Performance Monitoring license activated.

TABLE 11 Basic performance graphs

Graph type	Display description
Port Throughput	The performance of a port, in bytes per second, for frames received and transmitted.
Switch Aggregate Throughput	The aggregate performance of all ports on a switch.
Blade Aggregate Throughput	The aggregate performance of all ports on a port card. This graph is available only for the Brocade DCX and DCX-4S enterprise-class platforms.
Switch Throughput Utilization	The port throughput, in Gbps at the time the sample is taken. For the Brocade DCX and DCX-4S enterprise-class platforms, this graph displays the throughput for each slot. You can customize this graph to display information for particular ports.
Port Error	CRC errors for a given port.
Switch Percent Utilization	The percentage utilization for each port in a switch. For the Brocade DCX, this graph displays the percent utilization for each slot. You can customize this graph to display information for particular ports.
Port Snapshot Error	The CRC error count between sampling periods for all the ports on a switch. For the Brocade DCX and DCX-4S enterprise-class platforms, this graph displays the CRC error rate for each slot. You can customize this graph to display information for particular ports.

TABLE 12 Advanced performance monitoring graphs

Graph type	Display description
SID/DID Performance	The traffic between the SID-DID pair on the switch being managed. The member selection list in the LHS displays the port in the current switch only. The All Devices tab lists all the devices in the fabric. SID/DID Performance can be used to select the source and destination. For more information, refer to “Creating SID-DID Performance graphs” on page 97.
SCSI vs. IP Traffic	The percentage of SCSI versus IP frame traffic on each individual port. For more information, refer to “Creating the SCSI vs. IP Traffic graph” on page 98.
SCSI Commands by port and LUN (R, W, R/W)	The total number of read/write commands on a given port to a specific LUN. For more information, refer to “Creating SCSI command graphs” on page 98.

[Table 13](#) lists each graph and indicates the supported port types for each graph. The port selection columns for each graph displays the supported ports.

TABLE 13 Supported port types for Brocade switches

Graph type	Physical FC ports	Logical FC ports	GbE ports
Port Throughput	P	P	P
Switch Aggregate Throughput	N/A	N/A	N/A
Blade Aggregate Throughput ¹	N/A	N/A	N/A
Switch Throughput Utilization	P	N/A	P
Port Error	P	P	P

TABLE 13 Supported port types for Brocade switches (Continued)

Graph type	Physical FC ports	Logical FC ports	GbE ports
Switch Percent Utilization	P	N/A	P
Port Snapshot Error	P	P	N/A
SID/DID Performance	P	P	N/A
SCSI Commands	P	N/A	N/A
SCSI vs. IP Traffic	P	N/A	N/A

1. The Blade Aggregate Throughput graph is supported only on the Brocade DCX and DCX-4S enterprise-class platforms.

The labeling of the axes in the graphs depends on the switch type:

- For the Brocade DCX 8510-8, DCX 8510-4, and the DCX and DCX-4S enterprise-class platforms, slot numbers are displayed with expansion arrows next to them, as shown in [Figure 21](#) on page 93. Click the arrows to expand and contract the list of ports per slot.
- Switches such as the Brocade 300, 5100, 5300, 6510, 6520, 8000, VA-40FC, 7800 Extension, and the Brocade Encryption Switch do not have slot numbers because they have no blade FRUs, and therefore there is no need for slot numbering.
- For Brocade the Brocade DCX 8510-8, DCX 8510-4, and the DCX and DCX-4S enterprise-class platforms, the X-axis scales up to 409.6 Gbps in multiples of 2.
- For Brocade 300, 5100, 5300, VA-40FC, 6510, 6520, 8000, 7800 Extension, and the Brocade Encryption Switch, the X-axis scales up to 8.0 Gbps in increments of 0.8 Gbps.

Port throughput utilization is represented by a horizontal bar for each selected port. The horizontal bar gets longer or shorter depending on the percent utilization for that port at the last poll time. Thin short vertical intersecting bars give a historical perspective by representing the highest and lowest values reached for each selected port since the graph was opened. A third bar between them represents the average of all values polled.

NOTE

Virtual ports on logical switches cannot be graphed.

[Figure 21](#) shows how to access the list of Advanced Performance Monitoring graphs using Web Tools with the EGM license. This example displays the graphs available in the Performance Monitor window with the Advanced Performance Monitoring license installed. Note that the slot number is identified.

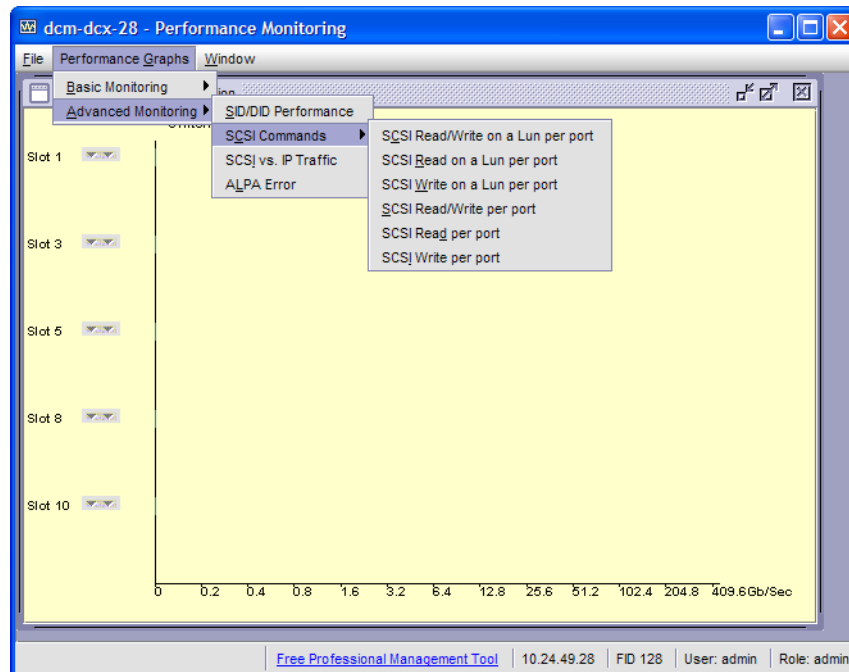

FIGURE 21 Accessing performance graphs

User-defined graphs

You can modify the predefined graphs to create your own customized graphs (refer to [“Customizing basic monitoring graphs”](#) on page 95 for more information). These user-defined graphs can be added and saved to canvas configurations.

Canvas configurations

A canvas is a saved configuration of graphs. The graphs can be either the Web Tools predefined graphs or user-defined graphs. Each canvas can hold up to eight graphs per window, with six shown in [Figure 22](#). Up to 20 canvases can be set up for different users or different scenarios. Each canvas is saved with a name and an optional brief description.

7 Opening the Performance Monitor window

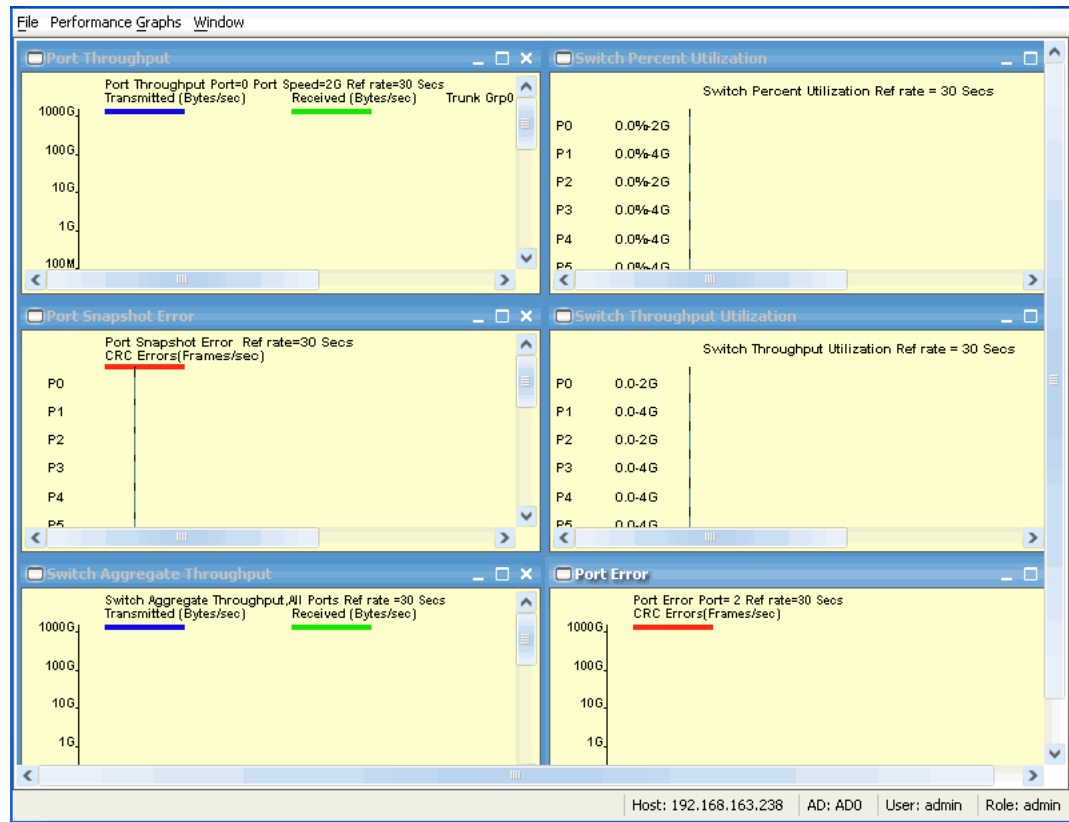

FIGURE 22 Canvas of six performance monitoring graphs

Opening the Performance Monitor window

To perform performance monitoring, you must use Web Tools with the EGM license; otherwise, access to this feature is denied and an error messages displays.

To open the **Performance Monitor** window, perform the following steps.

1. Select a switch from the **Fabric Tree** and log in when prompted.
2. Click **Monitor > Performance Monitor**. The **Performance Monitor** window displays.

Creating basic performance monitor graphs

To create the basic performance monitor graphs listed in [Table 11](#) on page 91, perform the following steps.

1. Open the **Performance Monitor** window.
2. Select **Performance Graphs > Basic Monitoring > Graph Type**.

Depending on the type of graph you select, you might be prompted to select a slot or port for which to create a graph.

3. If prompted, drag the port into the **Enter/drag slot,port** field, or manually enter the slot and port information in the field, in the format *slot,port*.

NOTE

For the Brocade 300, 5100, 5300, 6510, 6520, VA-40FC, 7800 Extension, 8000, and the Encryption Switch, enter only a port number.

4. Click **OK**.

The graph is displayed in a window in the **Performance Monitor** window.

Customizing basic monitoring graphs

You can customize some of the basic performance monitoring graphs to display information for particular ports. For the Brocade 8510-8, Brocade 8510-4, and Brocade DCX and DCX-4S enterprise-class platforms, you can also customize these graphs to display information for a slot.

You can customize the following graphs:

- Switch Throughput Utilization
- Switch Percent Utilization
- Port Snapshot Error

The following procedure assumes that you already created one of these customizable graphs.

1. Create or access the graph you want to customize.

Refer to [“Creating basic performance monitor graphs”](#) on page 94 for instructions on creating a graph.

2. **For Brocade 8510-8, Brocade 8510-4, and Brocade DCX and DCX-4S enterprise-class** platforms, display the detailed port throughput utilization rates for each port in a slot by clicking the arrows next to a slot. The port information for that slot displays in the graph.

NOTE

For the Brocade 300, 5100, 5300, 6510, 6520, VA-40FC, 7800 Extension, 8000, and the Encryption Switch, proceed to [step 3](#).

3. To display detailed port throughput utilization rates for particular ports only, right-click anywhere in the graph and click **Select Ports**.

The setup dialog box displays, as shown in [Figure 23](#).

The title of the dialog box varies, depending on the type of graph you are customizing, but the layout of the dialog box is the same. [Figure 23](#) displays an example of the setup dialog box for the **Edit Switch Throughput Utilization** graph.

7 Customizing basic monitoring graphs

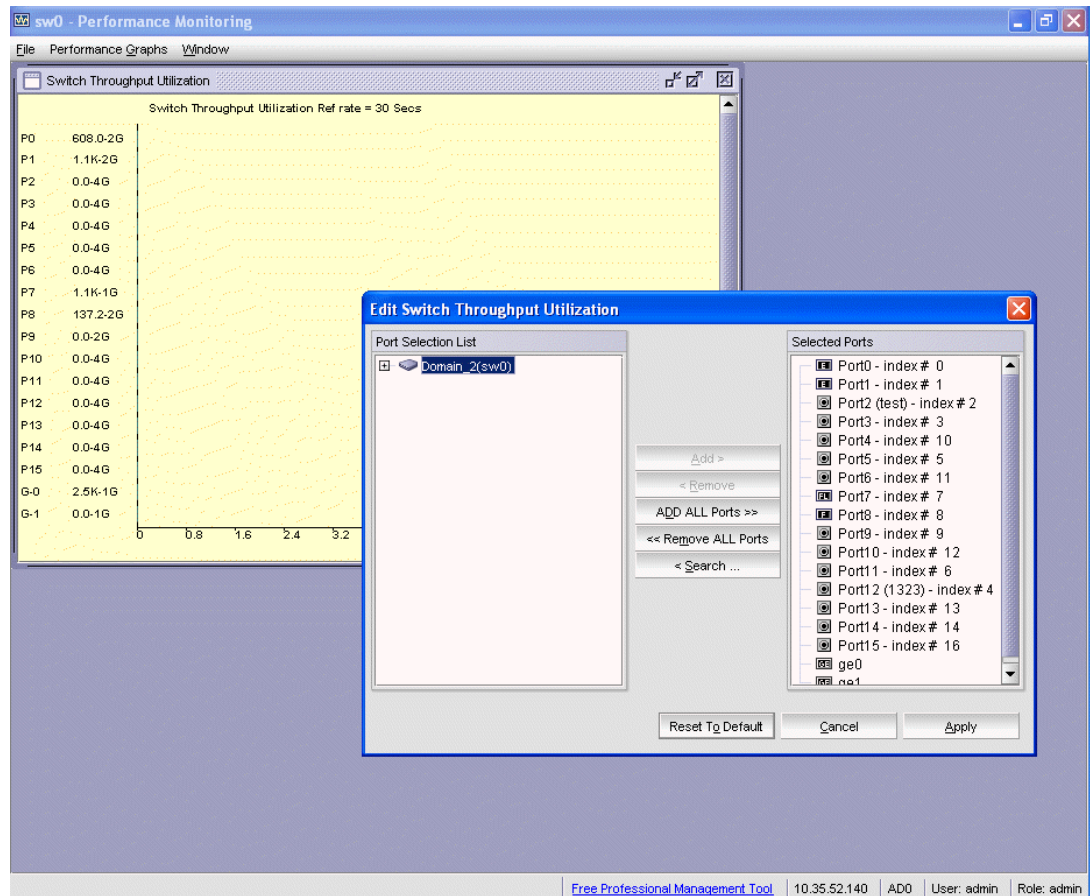

FIGURE 23 Select Ports for customizing the Switch Throughput Utilization graph

You can perform the following in the dialog box:

- Double-click the domain to expand the slot or port list.

NOTE

For the Brocade 8510-8, Brocade 8510-4, and Brocade DCX and Brocade DCX-4S enterprise-class platforms, click the plus (+) signs to expand the ports under each slot, as shown in [Figure 23](#).

- Click the port you want to monitor in the graph in the **Port Selection List**.
Use **Shift+click** and **Ctrl+click** to select multiple ports.
- Click **Add** to move the selected ports to the Selected Ports list.
- Optional:* Click **ADD ALL Ports** to add all of the ports in the **Port Selection List** to the Selected Ports list.
- Optional:* Click **Search** to open the **Search Port Selection List** dialog box, from which you can search for all E_Ports, all F_Ports, or all port names with a defined string. Select the ports you want to add and click **Search** in the **Search Port Selection List** dialog box.
- Click **Apply**.

Only the selected ports are displayed in the graph.

Advanced performance monitoring graphs

This section describes how to create the advanced performance monitor graphs listed in [Table 12](#) on page 91. Because the procedure for creating these graphs differs depending on the type of graph, each type is described separately in the sections that follow.

The advanced monitoring graphs are not supported for GbE ports.

NOTE

You must have an Advanced Performance Monitoring license installed to use the Advance Performance Monitor features. If user-defined Admin Domains are configured, Advanced Performance Monitoring works only in AD255.

Creating SID-DID Performance graphs

The SID/DID Performance graph displays the traffic between a SID-DID pair on the switch being managed.

To create a SID-DID performance graph, perform the following steps.

1. Open the **Performance Monitoring** window.
2. Select **Performance Graphs > Advanced Monitoring > SID/DID Performance**. The **SID/DID Performance Setup** dialog box displays.
 - To see the end-to-end (EE) monitors that are currently set up on a particular port, proceed to [step 3](#).
 - To specify the port, Source ID and Domain ID, skip to [step 4](#).

NOTE

Only the FC ports of the launched switch display in the tree. The **All Devices** tab lists all the devices in the fabric and lets you select the source and destination. Slot and port information of other switches is not displayed in the tree.

3. Click a port from the **Slot/Port** or **Sid/Did Selection List**.
 - a. Drag the selected port into the **Enter/drag slot, port number** field.
 - b. Click **Retrieve preset EE monitors**. The current end-to-end monitors for that port are displayed in the “Current EE monitors set for selected port” table.
 - c. *Optional:* To display a performance graph for the current EE monitors set for the selected port, click a SID-DID pair in the table. You can select multiple Source ID and Destination IDs. Click **Select**. If you selected multiple SID/DID monitors, click **OK** in the confirmation dialog box that displays. Skip to [step 6](#). If you do not want to display a performance graph for the current EE monitors set for the selected port, continue with [step 4](#).
4. Select a source ID from the **Port or Sid/Did Selection List**, and click **Add Sid**.

You can also enter a source ID in the **Enter/drag SID number** field.
5. Select a destination ID from the **Port or Sid/Did Selection List**, and click **Add Did**.

You can also enter a destination ID in the **Enter/drag DID number** field.
6. Click **OK**.

If you selected multiple EE monitors, SIDs, or PIDs, a confirmation dialog box displays, reminding you that one graph is opened for each selection.

7. Click **Yes** to display the graphs.
8. When you close a graph, a dialog box asks if you want to save the monitor.
If you click **OK**, the monitor is saved, and persists if the switch is restarted.

Creating the SCSI vs. IP Traffic graph

The SCSI vs. IP Traffic graph displays the SCSI versus IP traffic for selected ports. For Brocade 8510-8, Brocade 8510-4, and Brocade DCX and Brocade DCX 4S enterprise-class platforms, the slot and port name are identified in the graph.

In a trunk group, the SCSI vs. IP Traffic graph displays only the master port and not the slave ports.

To create a SCSI vs. IP Traffic graph, perform the following steps.

1. Open the **Performance Monitor** window.
2. Select **Performance Graphs > Advanced Monitoring > SCSI vs. IP Traffic**.

The **SCSI vs. IP Traffic Setup** dialog box displays. This dialog box is similar to that shown in [Figure 23](#) on page 96.

3. Double-click the domain to expand the slot/port list.

NOTE

For Brocade 8510-8, Brocade 8510-4, and Brocade DCX and Brocade DCX 4S enterprise-class platforms, click the plus (+) signs to expand the ports under each slot, as shown in [Figure 23](#).

4. Click the port you want to monitor in the graph in the **Port Selection List**. Use Shift+click and Ctrl+click to select multiple ports.
5. Click **Add** to move the selected ports to the Selected Ports list.
6. *Optional:* Click **ADD ALL Ports** to add all of the ports in the **Port Selection List** to the Selected Ports list.
7. *Optional:* Click **Search** to open the **Search Port Selection List** dialog box, from which you can search for all E_Ports, all F_Ports, or all port names with a defined string. Select the ports you want to add and click **Search** in the **Search Port Selection List** dialog box.
8. Click **Apply** in the **SCSI vs. IP Traffic Setup** dialog box.

Only the selected ports are displayed in the SCSI vs. IP traffic graph.

Creating SCSI command graphs

This graph displays the total number of read or write (or both) commands on a given port or to a specific LUN on a given port.

To create a SCSI command graph, perform the following steps.

1. Open the **Performance Monitor** window.
2. Select **Performance Graphs > Advanced Monitoring > SCSI Commands > Graph Type**.

The applicable setup dialog box displays.

3. Navigate to a **switch > slot > port** in the **Port Selection List**.
4. Click the port from the **Port Selection List** and drag it into the **Enter/drag port** field.
5. *Optional:* For the LUN per port graphs, enter a LUN number, in hexadecimal notation.

For the Brocade Encryption Switch, you can enter up to eight LUN masks

For the Brocade 5100, 5300, 300, 7800, and 8000, you can enter up to eight LUN masks

For all other switches running Fabric OS 4.x or v5.x, you can enter up to two LUN masks.

For switches running Fabric OS 3.x, you can enter up to three LUN masks.

6. Click **OK**.

The selected graph displays in the canvas.

Tunnel and TCP performance monitoring graphs

This section describes how to generate the Tunnel and TCP performance monitor graphs. You can launch maximum of four Tunnel and TCP graphs for a switch at a time. A total of 16 TCP connection graphs can be launched for a switch.

The TCP graphs available are:

- Sender RoundTrip
- Sender RoundTripVariance
- TCP DupAck
- TCP OOS
- TCP SlowStart
- TCP FastRetransmit
- TCP Tx(MB/sec)
- TCP Rx(MB/sec)

The Tunnel graphs available are:

- Throughput(MB/sec)
- Effective Throughput(MB/sec)
- CompressionRatio

For TCP connection graphs, tool tip is displayed only for all selected connections.

To create a Tunnel and TCP graph, perform the following steps.

1. Select **Monitor > Performance Monitor**.

The **Performance Monitor** window displays.

2. Select **Performance Graphs > Tunnel and TCP Graph**.

The **Tunnel and TCP Graph** dialog box displays.

3. Select the tunnel from the **Tunnels** drop-down list for which you want to generate the graphs.

For Brocade 7800 extension switch, you can have maximum six circuit connections in a tunnel and for FX8-24 DCX extension blade, you can have maximum of ten circuit connections in a tunnel.

4. In the **Tunnel and TCP** area at the bottom of the screen, select the required check boxes for the statistic you want to graph.

Note that each column represents a different graph.

5. Click **Options** to set the display options for the graphs.
 - **Range:** The range is from 3 through 30 seconds. The X axis is limited to 30 minutes. The graph scale starts with 0 minutes and auto scales to draw the statistics. Once the 30 minutes graph is drawn, the first minute data is removed to accommodate the 31st minute values.
 - **Global auto scaling:** By default, this option is in disabled mode. User can either enable or disable this option. If enabled, the graph's X-axis scale up to 30 minutes and if it is disabled, the X-axis will scale up to 10 minutes
 - Number of graphs per row: Designate how many graphs you wish to appear in each row.
6. Click **Generate**.
7. Click **Reset** to reset all the graphs.

NOTE

Brocade Network Advisor has an option for launching the TCP circuit Performance statistics dialog .

Tunnel and TCP graph chart properties

When a Tunnel and TCP graph displays, you can right-click the graph to access the display properties.

These properties include:

- Font selection
- Background color selection
- Title text
- Display zoom

These value selections are not persistent. When you close the graph, these values reset to the default settings.

In addition, you can print the graph and save the graph to a file

Saving graphs to a canvas

Saving graphs is useful when you create customized graphs and do not want to recreate them each time you access the **Performance Monitor** window. When you save graphs, you must save them to a canvas.

The following procedure describes how to save graphs to a new canvas.

1. Open the **Performance Monitor** window.
2. Create basic or advanced Performance Monitor graphs, as described in [“Creating basic performance monitor graphs”](#) on page 94 and [“Advanced performance monitoring graphs”](#) on page 97.

The graphs display in the **Performance Monitor** window.

3. Select **File > Save Current Canvas Configuration**.
The **Save Canvas Configuration** dialog box displays.
4. Enter a name and description for the configuration and click **Save Canvas**. A message displays, confirming that the configuration was successfully saved to the switch.

Adding graphs to an existing canvas

The following procedure assumes that a canvas is already created.

To create a new canvas, you must first create graphs, as described in [“Creating basic performance monitor graphs”](#) on page 94 and [“Advanced performance monitoring graphs”](#) on page 97, and then save those graphs to a canvas, as described in [“Saving graphs to a canvas”](#) on page 100.

To add a graph to an existing canvas, perform the following steps.

1. Select **File > Display Canvas Configurations**.
The **Canvas Configuration List** displays. The error message “No Canvas configuration to display” displays if there are no saved canvas configurations.
2. Click a canvas in the list.
3. Click **Edit**.
The **Edit Canvas** dialog box displays.
4. Click **Add**.
A list of graphs displays.
5. Click a graph to add it to the canvas and click **Save**.

Printing graphs

You can print a single graph or all the graphs displayed on the selected canvas configuration. Only one canvas configuration can be opened at a time.

To print a graph, perform the following steps.

1. Open the **Performance Monitor** window.
2. Create a basic or advanced Performance Monitor graph as described in [“Creating basic performance monitor graphs”](#) on page 94 and [“Advanced performance monitoring graphs”](#) on page 97.
3. To print a single graph, right-click the graph and choose **Print**. To print all the graphs displayed on the selected canvas configuration, select **File > Print All Graphs**.
4. In the print dialog box, click **OK**.

Modifying graphs

To modify an existing graph that is saved in a canvas, perform the following steps.

7 Modifying graphs

1. Open the **Performance Monitor** window.
2. Select **File > Display Canvas Configurations**.

The **Canvas Configuration List** displays. A message “No Canvas configuration to display” displays if there are no saved canvas configurations.

3. Select a canvas from the list and click **Edit**.

The **Performance Monitor Canvas: Canvas Name** dialog box displays.

4. Select a graph from the list and click **Edit**.

NOTE

The **Edit** button is enabled only for the graphs that are configurable or editable.

5. Make changes in the **Edit** dialog box, as necessary.
6. Click **OK** to close the **Edit** dialog box.
7. Click **Save** to save the changes and close the **Performance Monitor Canvas** dialog box.
8. Click **Close** to close the **Canvas Configuration List**.

Administering Zoning

In this chapter

- [Zoning overview](#) 103
- [Zoning configurations](#) 104
- [Zoning management](#) 105
- [Zone configuration and zoning database management](#) 115
- [Best practices for zoning](#) 122

Zoning overview

This chapter describes zoning and provides the procedures for managing zoning. The **Zone Admin** window provides two zoning options on the left pane:

- Basic zones
- Traffic isolation zones

You can perform basic zoning and traffic isolation zones using Web Tools and Web Tools with the EGM license.

Basic zones

Basic zoning enables you to partition a storage area network (SAN) into logical groups of devices that can access each other. For example, you can partition a SAN into two zones, *winzone* and *unixzone*, so that the Windows servers and storage do not interact with UNIX servers and storage.

Zones can be configured dynamically. They can vary in size, depending on the number of fabric-connected devices, and devices can belong to more than one zone. Because zone members can access only other members of the same zone, a device not included in a zone is not available to members of that zone.

Traffic Isolation zones

A traffic isolation zone (TI zone) is a special zone that creates a dedicated path for a specific traffic flow. TI zones are primarily for shaping and controlling traffic rather than partitioning access to storage.

LSAN zone requirements

An LSAN zone enables device connectivity between fabrics connected in Fibre Channel Routing (FCR) configurations without forcing you to merge fabrics. Extension switches provide multiple mechanisms to manage interfabric device connectivity. Zones that contain hosts and targets that are shared between the two fabrics need to be explicitly coordinated. To share devices between any two fabrics, you must create an LSAN zone in both fabrics considering the following:

- The name of an LSAN begins with the prefix `LSAN_`. The prefix is not case sensitive.
- Members must be identified by their port WWN because port IDs are not necessarily unique across fabrics.

QoS zone requirements

A QoS zone is a special zone that assigns a Quality of Service (QoS) level for traffic flow between a given host or target pair. The members of a QoS zone are WWNs of the host or target pairs. QoS zones can contain only WWN members. A QoS zone has a special prefix, to differentiate it from a regular zone. The formats and meaning of the QoS zone name prefix are shown in [Table 14](#) (the names are not case dependent).

TABLE 14 QoS zone name prefixes

QoS name prefix	Priority	Bandwidth assignment
QoSH_	High	Five virtual circuits, 60% of available bandwidth
QoSM_	Medium	Four virtual circuits, 40% of available bandwidth
QoSL_	Low	Two virtual circuits, 10% of available bandwidth

Zoning configurations

The **Zone Administration** window is where all of the zoning tasks are performed.

When performing zoning tasks for switches in a mixed fabric—that is, a fabric containing two or more switches running different fabric operating systems—you should use the switch with the highest Fabric OS level. Refer to [“Best practices for zoning”](#) on page 122 for more recommendations about zoning.

Opening the Zone Admin window

Launching the **Zone Administration** window and performing any kind of zone configuration takes more time if there are a large number of entries in the zone database. If the zone count is above 10000, the time taken for completing the operation increases proportionately.

You cannot open the **Zone Administration** window from AD255 (physical fabric).

To open a Zone Administration window, perform the following steps.

1. Select a switch from the **Fabric Tree**.
2. Click **Configure > Zone Admin**.

The **Zone Administration** window displays, as shown in [Figure 24](#).

Setting the default zoning mode

The default zoning mode has two options:

- **All Access**—All devices within the fabric can communicate with all other devices.
- **No Access**—Devices in the fabric cannot access any other device in the fabric.

NOTE

You should not change the default zone mode from No Access to All Access if there is no effective zone configuration and more than 120 devices are connected to the fabric.

Web Tools supports default zoning on switches running firmware v5.1.0 or later. Default zoning on legacy switches (switches running firmware versions prior to v 5.1.0) are not supported. Legacy switches can use default zoning; however, they cannot manipulate the default zone or default configuration.

To set the default zoning mode, perform the following steps.

1. Open the **Zone Administration** window (refer to [“Opening the Zone Admin window”](#) on page 104).
2. Select **Zoning Actions > Set Default Mode**, and then select the access mode.

Zoning management

You can monitor and manage basic and traffic isolation zoning through the Web Tools **Zone Administration** window. The information in the **Zone Administration** window is collected from the selected switch.

If the FCS policy is activated in the fabric, zoning can be administered only from the primary FCS switch. If the selected switch has an Advanced Zoning license installed, but is not the primary FCS switch, the **Zone Admin** option is displayed, but not activated.

You must be logged into the switch using a user name with one of the following roles associated with it to make changes to the zoning: zoneAdmin, admin, fabricAdmin, or any user-defined role with modify rights. All other roles allow only a view or read-only access. Most of the zoning operations are disabled in read-only mode.

A snapshot is taken of all the zoning configurations at the time you launch the **Zone Administration** window; this information *is not updated automatically* by Web Tools. To update this information, refer to [“Refreshing Zone Administration window information”](#) on page 108.

When you log in to a virtual switch, or select a virtual switch using the drop-down list under **Fabric Tree** section in the **Switch Explorer** window, only the ports that are associated with the Virtual Fabric ID you selected are displayed in the member selection list, as shown in [Figure 24](#). You can use the **Add Other** button to add ports of other switches in the fabric.

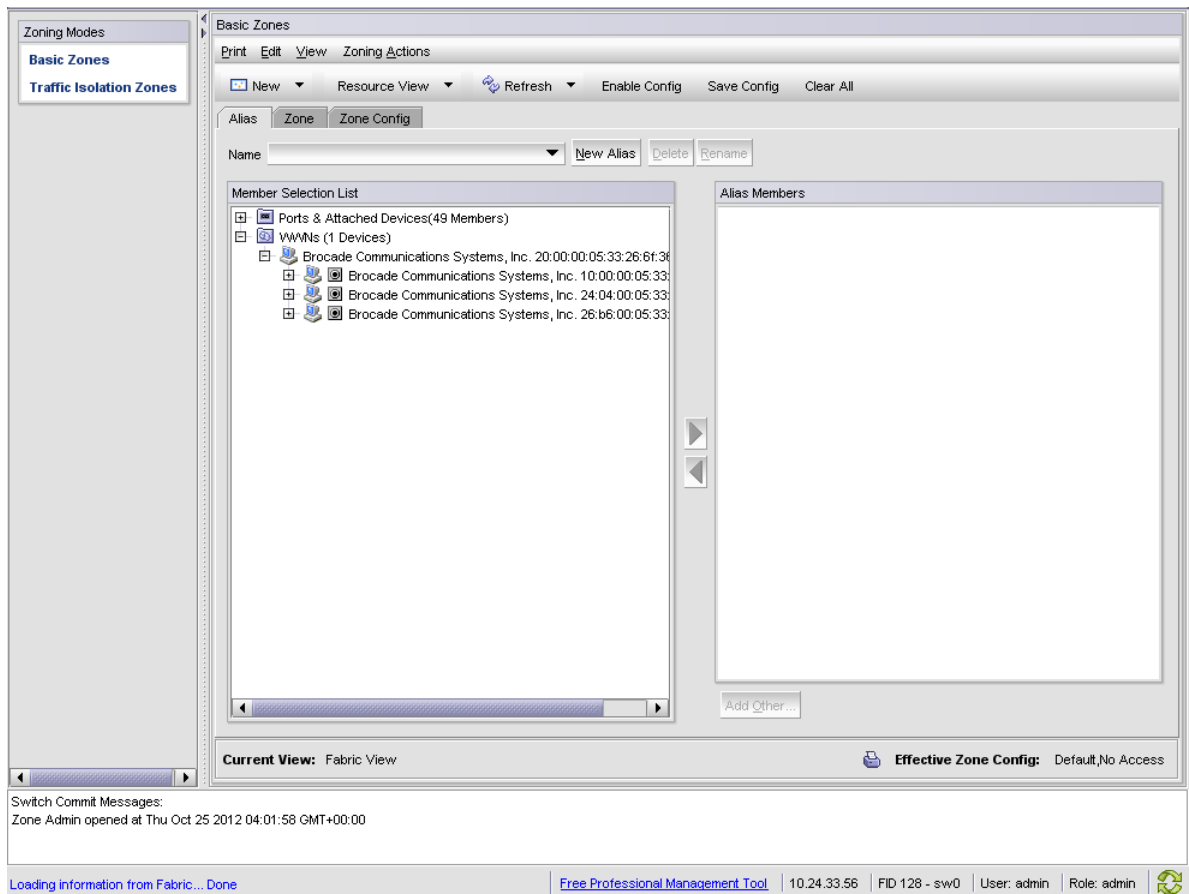

FIGURE 24 Zone Administration window

ATTENTION

Any changes you make in the **Zone Administration** window are held in a buffered environment and are not updated in the zoninging database until you save the changes. If you close the **Zone Administration** window without saving your changes, your changes are lost. To save the buffered changes you make in the **Zone Administration** window to the zoninging database on the switch, refer to [“Saving local zoning changes”](#) on page 108.

Note the following:

- “Saving” means updating the zoninging database on the switch with the local changes from the Web Tools buffer.
- “Refreshing” means copying the current state of the zoninging database on the switch to the Web Tools buffer, overwriting its current contents.

In the **Zone Administration** window, all WWNs also display vendor names.

The **Member Selection List** only lists the ports of the current switch and the devices of all the switches in the fabric. Slot and port information of other switches are not displayed in the tree.

Click the **Alias** tab to display which aliases the port or device is a member of. Also, you can right-click the device nodes and click **View Device Detail** to display detailed information about the selected device.

The **Member Selection List** panel displays only physical FC ports. To verify whether you have any unzoned devices, you must use Brocade Network Advisor to analyze zone configurations.

In the **Member Selection List**, you can differentiate between node WWN and port WWN with their icons as shown in Figure 25 and Figure 26.

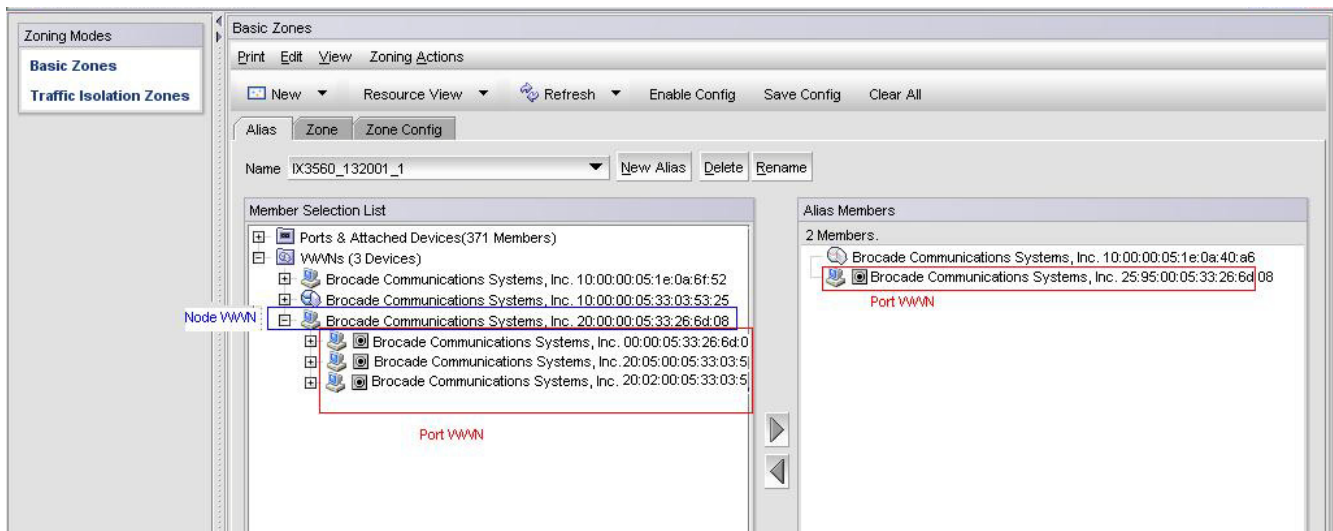

FIGURE 25 Port WWN icon for host

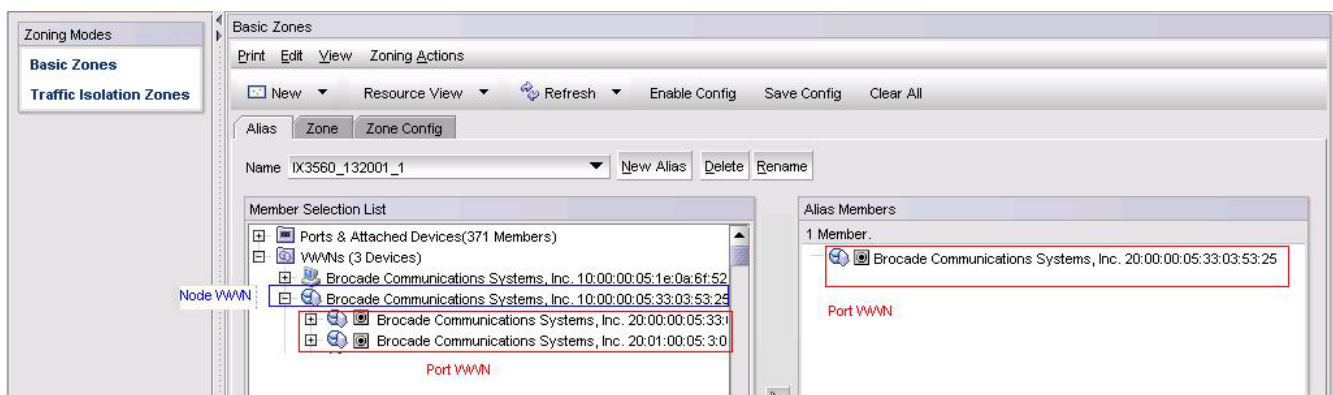

FIGURE 26 Port WWN icon for device

Refreshing fabric information

This function refreshes the display of *fabric elements* only (switches, ports, and devices). It does not affect any zoning element changes or update zone information in the **Zone Administration** window. You can refresh the fabric element information displayed at any time.

To refresh fabric information.

1. Open the **Zone Administration** window.
2. Select **View > Refresh From Live Fabric**.

This refreshes the status for the fabric, including switches, ports, and devices.

Refreshing Zone Administration window information

The information displayed in the **Zone Administration** window is initially a snapshot of the contents of the fabric zoning database at the time the window is launched. Any changes you make to this window are saved to a local buffer; but they are not applied to the fabric zoning database until you invoke one of the transactional operations listed in the **Zoning Actions** menu.

Any local zoning changes are buffered by the **Zone Administration** window until explicitly saved to the fabric. If the fabric zoning database is independently changed by another user or from another interface (for example, the CLI) while Web Tools zoning changes are still pending, the refresh icon starts to blink (after a 15–30 second polling delay). You can then decide to refresh the current Web Tools zoning view to reflect the new, externally changed contents of the fabric zoning database, in which case any pending local changes are lost, or you can ignore the blinking refresh icon and save your local changes, overwriting the external changes that triggered the icon to blink.

You can refresh zoning to back out of current, unsaved work and start over.

You can refresh the zoning information at any time, either using the refresh icon (whether it is flashing or not) or from the **View** menu.

The following procedure updates the information in the **Zone Administration** window with the information saved in the zoning database on the switch.

ATTENTION

When you refresh the buffered information in the **Zone Administration** window, any zoning configuration changes you made *and not yet saved* are erased from the buffer and replaced with the currently enabled zone configuration information that is saved on the switch.

To refresh the **Zone Administration** window, perform the following steps.

1. Launch the **Zone Administration** window as described in [“Opening the Zone Admin window”](#) on page 104.
2. Select **View > Refresh Zoning** or click **Refresh**.

This re-displays the information in the **Zone Administration** window with the information in the switch’s zoning database. This action also refreshes the fabric information as described in [“Refreshing fabric information”](#) on page 107. Any unsaved zoning changes are deleted.

Saving local zoning changes

All information displayed and all changes made in the **Zone Administration** window are buffered until you save the changes. In that case any other user looking at the zone information for the switch do not see the changes you have made until you save them.

Saving the changes propagates any changes made in the **Zone Administration** window (buffered changes) to the zoning database on the switch. If another user has a zoning operation in progress at the time that you attempt to save changes, a warning displays that indicates that another zoning transaction is in progress on the fabric. You can select to abort the other transaction and override it with yours.

If the zoning database size exceeds the maximum allowed, you cannot save the changes. The zoning database summary displays the maximum zoning database size.

This action updates the entire contents of the **Zone Administration** window, not just the selected zone, alias, or configuration. You can save your changes at any time during the **Zone Administration** session.

To save the local zone changes, perform the following steps.

1. Make the zoning changes in the **Zone Administration** window.
2. Select **Zoning Actions > Save Config**.

NOTE

If you have made changes to a configuration, you must enable the configuration before the changes are effective. To enable the configuration, refer to [“Enabling zone configurations”](#) on page 118.

Selecting a zoning view

You can define how zoning elements are displayed in the **Zone Administration** window. The zoning view you select determines how members are displayed in the **Member Selection List** panel ([Figure 24](#)). The views filter the fabric and device information displayed in the **Member Selection List** for the selected view, making it easier for you to create and modify zones, especially when creating “hard zones.”

Depending on the method you use to zone, certain tabs might or might not be available in the **Zone Administration** window.

There are two views of defining members for zoning:

- **Fabric View**—Displays the physical hierarchy of the fabric, a list of the attached and imported physical devices (by WWN), and a list of the FC Virtual Initiators on switches that support iSCSI. In the Fabric View, you can select ports for port-based zoning or devices for WWN-based zoning.
- **Devices Only**—Displays a list of the attached and imported physical devices by WWN. You cannot select ports for port-based or mixed zoning schemes, nor can you select virtual initiators for iSCSI FC Zone creation.

To define the view of the fabric resource, perform the following steps.

1. Launch the **Zone Administration** window as described in [“Opening the Zone Admin window”](#) on page 104.
2. Select **View > Choose Fabric Resources View**.
3. Define the way you want to view the fabric resource and click **OK**.

Creating and populating zone aliases

An alias is a logical group of port index numbers and WWNs. Specifying groups of ports or devices as an alias makes zone configuration easier, by enabling you to configure zones using an alias rather than providing a long string of individual members. You can specify members of an alias using the following methods:

- Identifying members by switch domain and port index number pair, for example, 2, 20.
- Identifying members by device node and device port WWNs.

For more information on enabling the configuration, refer to [“Enabling zone configurations”](#) on page 118.

To create a zone alias, perform the following steps.

1. Open the **Zone Administration** window as described in [“Opening the Zone Admin window”](#) on page 104.
2. Select a format to display zoning members in the **Member Selection List** as described in [“Selecting a zoning view”](#) on page 109.
3. Select the **Alias** tab and click **New Alias**.
The **Create New Alias** dialog box displays.
4. In the **Create New Alias dialog box**, enter a name for the new alias and click **OK**.
The new alias displays in the **Name** list.
5. Expand the **Member Selection List** to view the nested elements.
The choices available in the **Member Selection List** depend on the selection in the **View** menu.
6. Click elements in the **Member Selection List** that you want to include in the alias. The **right arrow** becomes active.
7. Click the **right arrow** to add alias members.
Selected members move to the **Alias Members** window.
8. *Optional:* Repeat steps 6 and 7 to add more elements to the alias.
9. *Optional:* Click **Add Other** to include a WWN or port that is not currently a part of the fabric.
10. Select **Actions > Save Config** to save the configuration changes.

Adding and removing members of a zone alias

For more information on enabling the configuration, refer to [“Enabling zone configurations”](#) on page 118.

NOTE

When you assign a node WWN to an alias or zone, all of the WWPN's associated to that Node are also moved. This functionality is supported only for IMO mode. This behavior is duplicated in Brocade Network Assistant zoning. This functionality is supported only by selecting the node WWN and assigning it to the alias or zone.

To add or remove zone alias members, perform the following steps.

1. Open the **Zone Administration** window as described in [“Opening the Zone Admin window”](#) on page 104.
2. Select the **Alias** tab.
3. Select the alias you want to modify from the **Name** list.
4. Select an element in the **Member Selection List** that you want to add to the alias, or select an element in the **Alias Members** list that you want to remove.
5. Click the **right arrow** to add the selected alias member, or click the **left arrow** to remove the selected alias member.
The alias is modified in the Zone Admin buffer.
6. Select **Zoning Actions > Save Config** to save your configuration changes.

Renaming zone aliases

The new alias name cannot exceed 64 characters and can contain alphabetic, numeric, and underscore characters.

For more information on enabling the configuration, refer to [“Enabling zone configurations”](#) on page 118.

To change the name of a zone alias, perform the following steps.

1. Open the **Zone Administration** window as described in [“Opening the Zone Admin window”](#) on page 104.
2. Select the **Alias** tab and select the alias you want to rename from the **Name** list.
3. Click **Rename**.

The **Rename an Alias** dialog box displays.

4. Enter a new alias name and click **OK**.

The alias is renamed in the Zone Admin buffer. At this point, you can either save your changes or save and enable your changes.

5. Select **Zoning Actions > Save Config** to save the configuration changes.

Deleting zone aliases

You can remove a zone alias from the Zone Admin buffer. When a zone alias is deleted, it is no longer a member of the zones of which it was once a member.

NOTE

If you delete the only member zone alias, an error message is issued when you attempt to save the configuration.

To delete the zone aliases, perform the following steps.

1. Open the **Zone Administration** window as described in [“Opening the Zone Admin window”](#) on page 104.
2. Select the **Alias** tab.
3. Select the alias you want to delete from the **Name** list. and click **Delete**.

The **Confirm Deleting Alias** dialog box displays.

4. Click **Yes**.

The selected alias is deleted from the Zone Admin buffer. At this point, you can either save your changes or save and enable your changes.

5. Select **Zoning Action > Save Config** to save the configuration changes.

To enable the configuration, refer to [“Enabling zone configurations”](#) on page 118.

Creating and populating zones

A zone is a region within the fabric where specified switches and devices can communicate. A device can communicate only with other devices connected to the fabric within its specified zone.

To create a zone, perform the following steps.

1. Open the **Zone Administration** window as described in [“Opening the Zone Admin window”](#) on page 104.
2. Select a format to display zoning members in the **Member Selection List** as described in [“Selecting a zoning view”](#) on page 109.
3. Select the **Zone** tab.
4. Click **New Zone**.

The **Create New Zone** dialog box displays.

5. In the **Create New Zone dialog box**, enter a name for the new zone, and click **OK**.

LSAN zones and QoS zones have specific naming requirements:

- For LSAN zones, refer to [“LSAN zone requirements”](#) on page 104.
- For QoS zones, refer to [“QoS zone requirements”](#) on page 104.

The new zone displays in the **Name** list.

6. Expand the **Member Selection List** to view the nested elements. The choices available in the list depend on the selection made in the **View** menu.

7. Select an element in the **Member Selection List** that you want to include in your zone.

Note that LSAN zones should contain only port WWN members. The **right arrow** becomes active.

8. Click the **right arrow** to add the zone member.

The selected member is moved to the **Zone Members** window.

9. *Optional:* Repeat steps 7 and 8 to add more elements to your zone.

10. *Optional:* Click **Add Other** to include a WWN or port that is not currently a part of the fabric. At this point, you can either save your changes or save and enable your changes.

11. Select **Zoning Actions > Save Config** to save the configuration changes.

To enable the configuration, refer to [“Enabling zone configurations”](#) on page 118.

Adding and removing members of a zone

For information on enabling the configuration, refer to [“Enabling zone configurations”](#) on page 118.

NOTE

When you assign a node WWN to an alias or zone, all of the WWPN's associated to that Node are also moved. This functionality is supported only for IMO mode. This behavior is duplicated in Brocade Network Assistant zoning. This functionality is supported only by selecting the node WWN and assigning it to the alias or zone.

To add or remove zone members, perform the following steps.

1. Open the **Zone Administration** window as described in [“Opening the Zone Admin window”](#) on page 104.
2. Select the **Zone** tab.
3. Select the zone you want to modify from the **Name** list.

The zone members for the selected zone are listed in the **Zone Members** list.

4. Highlight an element in the **Member Selection List** that you want to include in your zone, or highlight an element in the **Zone Members** list that you want to delete.
5. Click the **right arrow** to add a zone member, or click the **left arrow** to remove a zone member. The zone is modified in the Zone Admin buffer.
6. Select **Zoning Actions > Save Config** to save the configuration changes.

Renaming zones

For information on enabling the configuration, refer to [“Enabling zone configurations”](#) on page 118.

To change the name of a zone, perform the following steps.

1. Open the **Zone Administration** window as described in [“Opening the Zone Admin window”](#) on page 104.
2. Click the **Zone** tab.
3. Select the zone you want to rename from the **Name** list.
4. Click **Rename**.
5. In the **Rename a Zone dialog box**, enter a new zone name and click **OK**. The zone is renamed in the Zone Admin buffer.
6. Select **Zoning Actions > Save Config** to save the configuration changes.

Cloning zones

To perform clone operations for zoning, the EGM license must be installed on the switch; otherwise, access to this feature is denied and an error message displays.

The EGM license is required only for 8 Gbps platforms, such as the following:

- Brocade Encryption Switch
- Brocade 300, 5300, and 5100 switches
- Brocade VA-40FC
- Brocade 8000
- Brocade 7800

For non-8 Gbps platforms, all functionalities are available without EGM license.

To clone a zone configuration, perform the following steps.

1. Open the **Zone Administration** window as described in [“Opening the Zone Admin window”](#) on page 104.
2. Click the **Zone** tab.
3. Select the zone you want to clone from the **Name** list.
4. Click **Clone**
5. In the **Clone an Existing Zone dialog box**, enter a name for the copied zone.
6. Click **OK**. The selected zone is copied from the Zone Admin buffer.

7. Select **Zoning Actions** > **Save Config** to save the configuration changes. Because no changes were made to the effective configuration, you do not need to enable the configuration.

Deleting zones

For information on enabling the configuration, refer to [“Enabling zone configurations”](#) on page 118.

To delete a zone, perform the following steps.

1. Open the **Zone Administration** window as described in [“Opening the Zone Admin window”](#) on page 104.
2. Click the **Zone** tab.
3. Select the zone you want to delete from the **Name** menu and click **Delete**.
4. On the confirmation dialog box, click **Yes**.

The selected zone is deleted from the Zone Admin buffer. At this point, you can either save your changes or save and enable your changes.

5. Select **Zoning Actions** > **Save Config** to save the configuration changes.

Creating and populating enhanced traffic isolation zones

An enhanced traffic isolation zone (TI zone) is a special zone that creates a dedicated path for a specific traffic flow. When an enhanced TI zone is activated, inter-switch traffic from a zone member is directed to E_Ports that are included in the TI zone. Traffic from outside the TI zone is excluded. A maximum of 255 TI zones can be configured. LSAN devices can be added only in TI zones created in the backbone switch.

A port may be assigned to more than one enhanced TI zone in a fabric. A port can be part of more than one enhanced TI zone provided following conditions are satisfied:

- All the switches in the fabric should have Fabric OS v 6.4 or later.
- A port can be assigned to multiple TI Zones that have the same failover state.
- The fabric is composed entirely of 8 Gbps capable FC platform or GoldenEye-2 switches:

To create and populate an enhanced TI zone, perform the following steps.

1. Open the **Zone Administration** window as described in [“Opening the Zone Admin window”](#) on page 104.
2. Under **Zoning Modes**, select **Traffic Isolation Zones**.
The Traffic Isolation Zones view displays.
3. Click **New** on the menu bar.
The Add TI Zone dialog box displays.
4. Expand the **Member Selection List** to view the nested elements.
5. Select an element in the **Member Selection List** that you want to include in your zone.
The right arrow becomes active.
6. Click the **right arrow** to add the zone member.
The selected member is moved to the **Zone Members** window.

NOTE

All switches in the fabric must be running Fabric OS v6.4.0 or later and all the ports in the TI zones must be in the same failover mode.

7. *Optional:* Repeat steps 5 and 6 to add more elements to your TI zone.
8. When you are finished, click **OK**. The **Traffic Isolations Zones** window displays.
9. Click **Apply** to save the TI zone configuration.

Zone configuration and zoning database management

A zone configuration is a group of zones; zoning is enabled on a fabric by enabling a specific configuration. You can specify members of a configuration using zone names.

Figure 27 displays a sample zoning database and the relationship between the zone aliases, zones, and zoning configuration. The database contains one zoning configuration, *myconfig*, which contains two zones: *Zone A* and *Zone B*. The database also contains four aliases, which are members of *Zone A* and *Zone B*. *Zone A* and *Zone B* also have additional members other than the aliases.

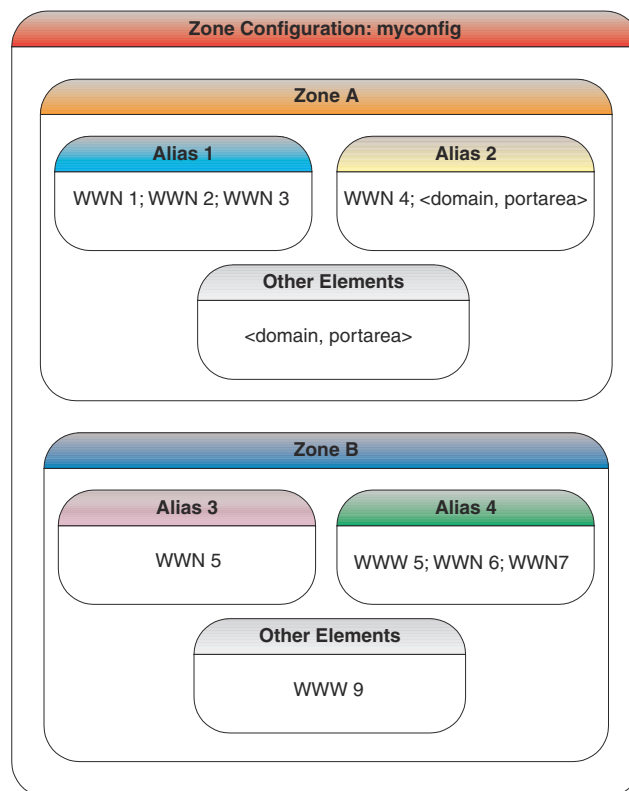

FIGURE 27 Sample zoning database

Creating zone configurations

To create a zone configuration, perform the following steps. After creating a zone configuration, you must explicitly enable it for it to take effect.

For information on enabling the configuration, refer to [“Enabling zone configurations”](#) on page 118.

NOTE

Any changes made to the currently enabled configuration does not display until you re-enable the configuration.

To create zone configurations, perform the following steps.

1. Open the **Zone Administration** window as described in [“Opening the Zone Admin window”](#) on page 104.
2. Select a format to display zoning members in the **Member Selection List** as described in [“Selecting a zoning view”](#) on page 109.
3. Select the **Zone Config** tab and click **New Zone Config**.
4. In the **Create New Config dialog box**, enter a name for the new configuration and click **OK**.
The new configuration displays in the **Name** list.
5. Expand the **Member Selection List** to view the nested elements.
The choices available in the list depend on the selection made in the **View** menu.
6. Select an element in the **Member Selection List** that you want to include in your configuration.
The **right arrow** becomes active.
7. Click the **right arrow** to add configuration members.
Selected members are moved to the **Config Members** window.
8. Repeat steps 6 and 7 to add more elements to your configuration.
9. Select **Zoning Actions > Save Config** to save the configuration changes.

Adding or removing zone configuration members

For information on enabling the configuration, refer to [“Enabling zone configurations”](#) on page 118.

To add or remove members of a zone configuration, perform the following steps.

NOTE

You can make changes to a configuration that is currently enabled; however, changes do not display until you re-enable the configuration.

To configure the zone members, perform the following steps.

1. Open the **Zone Administration** window as described in [“Opening the Zone Admin window”](#) on page 104.
2. Select the **Zone Config** tab.
3. Select the configuration you want to modify from the **Name** list.
4. Click an element in the **Member Selection list** that you want to include in your configuration or select the element in the **Config Members** list that you want to delete.

5. Click the **right arrow** to add a configuration member or the **left arrow** to remove a configuration member.
6. Select **Zoning Actions > Save Config** to save the configuration changes.

Renaming zone configurations

The new name cannot exceed 64 characters and can contain alphabetic, numeric, and underscore characters.

NOTE

You cannot rename the currently enabled configuration.

To rename the zone configuration, perform the following steps.

1. Open the **Zone Administration** window as described in [“Opening the Zone Admin window”](#) on page 104.
2. Select the **Zone Config** tab.
3. Select the configuration you want to rename from the **Name** list and click **Rename**.
4. In the **Rename a Config dialog box**, enter a new configuration name and click **OK**.
The configuration is renamed in the configuration database.
5. Select **Zoning Actions > Save Config** to save the configuration changes.

Cloning zone configurations

You must use Web Tools with the EGM license to perform cloning operations for zone configurations; otherwise, access to this feature is denied and an error message displays.

To clone a zone configuration, perform the following steps.

1. Open the **Zone Administration** window as described in [“Opening the Zone Admin window”](#) on page 104.
2. Select the **Zone Config** tab.
3. Select the zone configuration you want to clone from the **Name** list.
4. Click **Clone**.
5. In the **Copy An Existing Zone Config dialog box**, enter a name for the copied zone and click **OK**.
The selected zone is copied from the Zone Admin buffer.
6. Select **Zoning Actions > Save Config** to save the configuration changes.
No changes were made to the effective configuration. You do not need to enable the configuration.

Deleting zone configurations

To delete a zone configuration, perform the following steps.

NOTE

You cannot delete a enabled configuration.

1. Open the **Zone Administration** window as described in [“Opening the Zone Admin window”](#) on page 104.
2. Select the **Zone Config** tab.
3. Select the configuration you want to delete from the **Name** list and click **Delete**.
4. On the confirmation dialog box, click **Yes**. The selected configuration is deleted from the configuration database.
5. Select **Zoning Actions > Save Config** to save the configuration changes.

Enabling zone configurations

Several zone configurations can reside on a switch at the same time, and you can quickly alternate between them. For example, you might want to have one configuration enabled during the business hours and another enabled overnight. However, only one zone configuration can be enabled at a time.

When you enable a zone configuration from Web Tools, the entire zoning database is automatically saved, and then the selected zone configuration is enabled.

If the zoning database size exceeds the maximum allowed, you cannot enable the zone configuration. The zoning database summary displays the maximum zoning database size.

To enable the zone configuration, perform the following steps.

1. Open the **Zone Administration** window as described in [“Opening the Zone Admin window”](#) on page 104.
2. Select **Zoning Actions > Enable Config**.
3. On **Enable Config**, select the configuration to be enabled from the menu.
4. Click **OK** to save and enable the selected configuration.

Disabling zone configurations

When you disable the active configuration, the Advanced Zoning feature is disabled on the fabric, and all devices within the fabric can communicate with all other devices. This does not mean that the zoning database is deleted, however, only that there is no configuration active on the fabric.

When you disable a zone configuration from Web Tools, keep in mind that the entire zoning database is automatically saved, and then the selected zone configuration is disabled.

NOTE

When you disable the active configuration, Advanced Zoning is disabled on the fabric, and according to the default zone set, devices within the fabric can or cannot communicate with other devices.

To disable a zone configuration, perform the following steps.

1. Open the **Zone Administration** window as described in [“Opening the Zone Admin window”](#) on page 104.
2. Select **Zoning Actions > Disable Zoning**.

The **Disable Config** warning message displays.

3. Click **Yes** to save and disable the current configuration.

Displaying enabled zone configurations

The enabled zone configuration screen displays the actual content of the single zone configuration that is currently enabled on the fabric, whether it matches the configuration that was enabled when the current **Zone Admin** session was launched or last refreshed. The zones are displayed, and their contents (ports, WWNs) are displayed next to them. Aliases are not displayed in the enabled zone configuration. If there is no active zone configuration enabled on the switch, a message displays to that effect.

NOTE

The enabled configuration is listed in the lower-right corner of the **Zone Administration** window.

Viewing the enabled zone configuration name without opening the Zone Administration window

To view the enabled zone configuration name, perform the following steps.

1. Select a logical switch from the **Logical Switch** drop-down list in the top-right corner of the **Switch Explorer** window.

The selected switch displays in the **Switch View**.

2. You can view the current zone configuration name (if one is enabled) in the lower portion of the Switch Events and Switch Information window.

If no zone configuration is enabled, the field displays “No configuration in effect”.

Viewing detailed information about the enabled zone configuration

To view detailed information about the enabled zone configuration, perform the following steps.

1. Open the **Zone Administration** window, as described on [“Opening the Zone Admin window”](#) on page 104.

The zone configuration in effect at the time you launched the **Zone Administration** window is identified in the lower-right corner. It is also updated if you manually refresh the **Zone Administration** window contents by clicking the refresh icon at the lower-right corner of the **Zone Administration** window, or when you enable a configuration through the **Zone Administration** window.



CAUTION

Clicking the refresh icon overwrites all local unsaved zoning changes. If anyone has made any changes to the zones outside of your Zone Admin session, those changes are applied.

2. To identify the most recently effective zone configuration *without* saving or applying any changes you made in the **Zone Administration** window, select **Print > Print Effective Zone Configuration** in the **Zone Administration** window.

NOTE

If no zone is enabled, a message displays, indicating that there is no active zoning configuration on the switch.

3. *Optional:* Click **Print** located in the **Print Effective Zone Configuration** dialog box to print the enabled zone configuration details.

NOTE

You must use Brocade Network Advisor to print the zone database summary configurations, display zone configuration summaries and create configuration analysis reports.

Adding a WWN to multiple aliases and zones

This procedure enables you to configure a WWN as a member in a zone configuration prior to adding that device to the fabric. Specifically, it is useful if you want to add a WWN to all or most zoning entities. The added WWN does not need to currently exist in the fabric.

To add a WWN, perform the following steps.

1. Open the **Zone Administration** window as described in [“Opening the Zone Admin window”](#) on page 104.

2. Select **Edit > Add WWN**.

The **Add WWN** dialog box displays.

3. Enter a WWN value in the **WWN** field and click **OK**.

The **Add WWN** dialog box displays all the zoning elements that include the new WWNs. All of the elements are selected by default.

4. Click items in the list to select or clear, and click **Add** to add the new WWN to all the selected zoning elements.

The WWN is added to the Zone Admin buffer and can be used as a member.

Different icons are used to differentiate between node WWN and port WWN.

Removing a WWN from multiple aliases and zones

Use this procedure if you want to remove a WWN from all or most zoning entities.

1. Open the **Zone Administration** window as described in [“Opening the Zone Admin window”](#) on page 104.

2. Select **Edit > Delete WWN**.

The **Delete WWN** dialog box displays.

3. Enter a WWN value in the **WWN** field and click **OK**.

The **Delete WWN** dialog box displays all the zoning elements that include the WWN.

4. Click items in the list to select or unselect, and click **Delete** to delete the WWN from all the selected zoning elements.

The WWN is deleted from the selected items in the Zone Admin buffer.

Replacing a WWN in multiple aliases and zones

This procedure enables you to replace a WWN throughout the Zone Admin buffer. This is helpful when exchanging devices in your fabric and helps you to maintain your current configuration.

To replace a WWN in multiple aliases and zones, perform the following steps.

1. Launch the **Zone Administration** window as described in [“Opening the Zone Admin window”](#) on page 104.

2. Select **Edit > Replace WWN**.

The **Replace WWN** dialog box displays.

3. Enter the WWN to be replaced in the **Replace** field.

4. Enter the new WWN in the **By** field and click **OK**.

The **Replace WWN** dialog box displays. It lists all the zoning elements that include the WWN.

5. Click an item in the list to select or unselect, and click **Replace** to replace the WWN in all the selected zoning elements.

The former WWN is replaced in the Zone Admin buffer by the new WWN, including within any alias or zone in which the old WWN was a member.

Searching for zone members

You can search zone member selection lists for specified strings of text. If you know some identifying information about a possible member of a zoning entity, you can select the tab and view for that entity and then search through its member selection list using the **Search for Zone Member** option. If the target entity is an alias or zone, then the search domain includes elements like switch names and domain numbers, port names and “domain, port” addresses, device WWNs and manufacturer names, and also any aliases that might already have been defined. If the target entity is a configuration, then zones are also included, along with the elements they contain.

The search starts from the top of the list, and when the target element is found, it is also selected in the **Member Selection List** so it can be added or its parent or children can be found. By default, the **Member Selection List** is searched from beginning to end one time. If you select the wraparound option, the search continues to loop from the beginning to the end of the **Member Selection List**.

To search for zone members, perform the following steps.

1. Open the **Zone Administration** window as described in [“Opening the Zone Admin window”](#) on page 104.

2. Select **Edit > Search Member**.

3. Enter the zone member name in the **Member Name** field.

Optional: Narrow the search by selecting one or more of the check boxes, such as **Match Case**.

4. Click **Next** to begin the zone member search.

Clearing the zoning database

Use the following procedure to disable the active zoning configuration, if one exists, and delete the entire zoning database. You must disable any active configuration before you can delete the zoning database.

ATTENTION

This action not only disables zoning on the fabric, but also deletes the entire zoning database. This results in all devices being able to communicate with each other.

To clear the zone database, perform the following steps.

1. Open the **Zone Administration** window as described in [“Opening the Zone Admin window”](#) on page 104.
2. Select **Actions > Clear All**.
The **Disable Config** wizard displays.
3. Click **Yes** to do *all* of the following in the wizard:
 - Disable the current configuration.
 - Clear the entire contents of the current Web Tools Zone Admin buffer.
 - Delete the entire persistent contents of the fabric zoning database.

The wizard allows you to define one and only one name for each device port (WWN). Devices with one or more aliases are considered already named and are not displayed.

Zone configuration analysis

You must use Brocade Network Advisor to analyze the following zone configurations:

- Add unzoned devices
- Remove offline or inaccessible devices
- Replace offline devices
- Define device alias

Best practices for zoning

The following are recommendations for using zoning:

- Always zone using the highest Fabric OS-level switch.
Switches with lower Fabric OS versions do not have the capability to view all the functionality that a newer Fabric OS provides as functionality is backwards compatible but not forwards compatible.
- Zone using the core switch versus an edge switch.
- Zone using a director over a switch.
A director has more resources to handle zoning changes and implementations.
- Zone on the switch you connect to when bringing up Web Tools (the proxy switch).

Working with Diagnostic Features

In this chapter

- [Trace dumps](#) 123
- [Displaying switch information](#)..... 125
- [Defining Switch Policy](#)..... 128
- [Port LED interpretation](#) 130

Trace dumps

A trace dump is a snapshot of the running behavior within the Brocade switch. The dump can be used by developers and troubleshooters at Brocade to help understand what might be contributing to a specific switch behavior when certain internal events are seen. For example, a trace dump can be created each time a certain error message is logged to the system error log. Developers can then examine what led up to the message event by studying the traces.

Tracing is always “on.” As software on the switch executes, the trace information is placed into a circular buffer in system RAM. Periodically, the trace buffer is “frozen” and saved. This saved information is a “trace dump.”

A trace dump is generated when:

- It is triggered manually (use the **traceDump** command).
- A critical-level LOG message occurs.
- A particular LOG message occurs (use the **traceTrig** command to set up the conditions for this).
- A kernel panic occurs.
- The hardware watchdog timer expires.

(For information about the **traceDump** and **traceTrig** commands, refer to the *Fabric OS Command Reference*.)

The trace dump is maintained on the switch until either it is uploaded to the FTP host or another trace dump is generated. If another trace dump is generated before the previous one is uploaded, the previous dump is overwritten.

When a trace dump is generated, it is automatically uploaded to an FTP host if automatic FTP uploading is enabled.

Using the **Trace** tab of the **Switch Administration** window, you can view and configure the trace FTP host target and enable or disable automatic trace uploads.

How a trace dump is used

The generation of a trace dump causes a CRITICAL message to be logged to the system error log. When a trace dump is detected, issue the **supportSave** command on the affected switch. This command packages all error logs, the **supportShow** output, and trace dump, and moves these to your FTP server. You can also configure your switch to automatically copy trace dumps to your FTP server (refer to “[Setting up automatic trace dump transfers](#)”).

In addition to automatic generation of trace dumps on faults, you can also generate a trace dump manually or when certain system error messages are logged. This is normally done with assistance from Brocade customer support when diagnosing switch behavior.

For details on the commands, refer to the *Fabric OS Command Reference*.

Setting up automatic trace dump transfers

You can set up a switch so that diagnostic information is transferred automatically to a remote server. Then, if a problem occurs you can provide your customer support representative with the most detailed information possible. To ensure the best service, you should set up for automatic transfer as part of standard switch configuration, before a problem occurs.

Setting up for automatic transfer of diagnostic files involves the following tasks:

- Specifying a remote server to store the files.
- Enabling the automatic transfer of trace dumps to the server. (Trace dumps overwrite each other by default; sending them to a server preserves information that would otherwise be lost.)

Specifying a remote server

To specify a remote server, perform the following steps.

1. Open the **Switch Administration** window.
2. Click **Show Advanced Mode**, if it is not selected.
3. Select the **Trace** tab.
4. Enter the FTP host IP address, path of the remote directory for the trace dump files, FTP user name, and FTP password in the appropriate fields.

The IP address can be IPv4 or IPv6 format, or a DNS name.

The password is optional if you log in as an anonymous user.

5. Click **Apply**.

Enabling automatic transfer of trace dumps

To enable the automatic transfer of trace dumps, perform the following steps.

1. Open the **Switch Administration** window.
2. Click **Show Advanced Mode**, if it is not selected.
3. Select the **Trace** tab.
4. Select **Enable** in the **Auto FTP Upload** section to enable automatic uploading of the trace dump to the FTP host.

5. Click **Apply**.

Disabling automatic trace uploads

If automatic uploading of a trace dump is disabled, you must manually upload the trace dump or else the information is overwritten when a subsequent trace dump is generated.

To disable automatic trace uploads, perform the following steps.

1. Open the **Switch Administration** window.
2. Click **Show Advanced Mode**, if it is not selected.
3. Select the **Trace** tab.
4. Select **Disable** in the **Auto FTP Upload** section to disable automatic uploading of the trace dump to the FTP host.
5. Click **Apply**.

Displaying switch information

You can right-click in the table content of **Fan**, **Temperature**, and **Power Status** windows to find Export, Copy, and Search options. These options are not available if the table does not have any content.

- Click **Export Row** or **Export Table** to save the contents to a tab-delimited file.
- Click **Copy Row** or **Copy Table** to copy the contents in tab-delimited text format to a file.
- Click **Search** to search for a specific text string in the table.

NOTE

You must accept the Brocade Certificate at the beginning of the login to Web Tools to enable the functionality of Export and Copy.

Enter the text string in the box that displays on the table, as shown in [Figure 28](#), and press **Enter**. This is an incremental search and allows 24 maximum characters including wildcards question mark (?) and asterisk (*). The first row containing the text string is highlighted. To find the next match, click the down arrow. To find the previous match, click the up arrow. If the text is not found in the table, the text turns red.

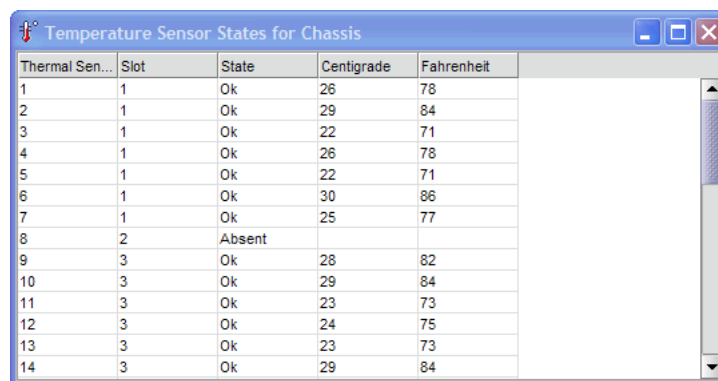

Thermal Sen...	Slot	State	Centigrade	Fahrenheit
1	1	Ok	26	78
2	1	Ok	29	84
3	1	Ok	22	71
4	1	Ok	26	78
5	1	Ok	22	71
6	1	Ok	30	86
7	1	Ok	25	77
8	2	Absent		
9	3	Ok	28	82
10	3	Ok	29	84
11	3	Ok	23	73
12	3	Ok	24	75
13	3	Ok	23	73
14	3	Ok	29	84

FIGURE 28 Temperature Sensor States window

Viewing detailed fan hardware status

The icon on the **Fan** button indicates the overall status of the fans. For more information about the switch fan, refer to the appropriate hardware documentation.

You can display status information about the fans, as shown in [Figure 29](#).

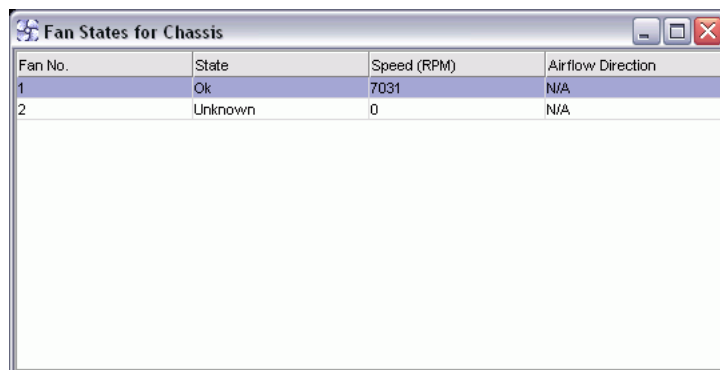

Fan No.	State	Speed (RPM)	Airflow Direction
1	Ok	7031	N/A
2	Unknown	0	N/A

FIGURE 29 Fan States window

The **Fan No.** column indicates either the fan number or the fan FRU number, depending on the switch model. A fan FRU can contain one or more fans. The **Fan No.** column indicates the fan FRU number when it is available, otherwise it displays the fan number.

The **AirFlow Direction** column displays the direction state as either **Forward** or **Backward** for the Brocade 6510 and Brocade 6520. For all other hardware, the displayed value will be **N/A**.

NOTE

If the Fan States window has no “Fan Speed” column, *the speed is not monitored*.

To view the detailed fan status of a switch, perform the following steps.

1. Select a logical switch from the **Logical Switch** drop-down list in the top-right corner of the **Switch Explorer** window.

The selected switch displays in the **Switch View**. The icon on the **Fan** button indicates the overall status of the fan.

2. Click the **Fan** button.

The detailed fan status for the switch displays, as shown in [Figure 29](#).

Viewing the temperature status

The icon on the **Temp** button indicates the overall status of the temperature. For more information regarding switch temperature, refer to the appropriate hardware documentation.

To view the temperature status, perform the following steps.

1. Select a logical switch from the **Logical Switch** drop-down list in the top-right corner of the **Switch Explorer** window.

The selected switch displays in the **Switch View**. The icon on the **Temp** button indicates the overall status of the temperature.

2. Click **Temp** on the **Switch View**.

The detailed temperature sensor states for the switch are displayed, as shown in [Figure 28](#).

Viewing the power supply status

The icon on the **Power** button indicates the overall status of the power supply status. For more information regarding switch power modules, refer to the appropriate hardware documentation.

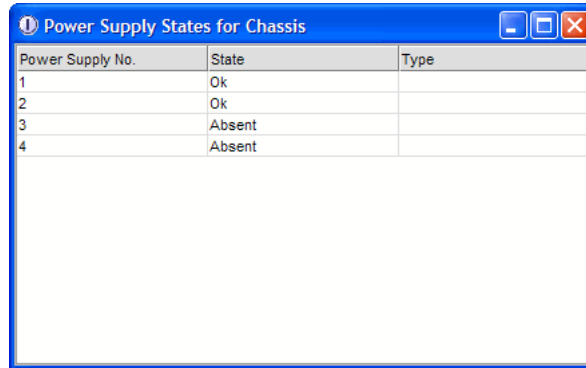

Power Supply No.	State	Type
1	Ok	
2	Ok	
3	Absent	
4	Absent	

FIGURE 30 Power States window

To view the power supply status, perform the following steps.

1. Select a logical switch from the **Logical Switch** drop-down list in the top-right corner of the **Switch Explorer** window.
2. The selected switch displays in the **Switch View**. The icon on the **Power** button indicates the overall status of the power supply.
3. Click **Power** on the **Switch View**. The detailed power supply states are displayed ([Figure 30](#)). If you are using the Brocade 6510 or Brocade 6520, the **Type** column displays either **AC** or **DC**. For all other hardware the value will be **N/A**.

Checking the physical health of a switch

The **Status** button displays the operational state of the switch. The icon on the button displays the real-time status of the switch.

If no data is available from a switch, the most recent background color remains displayed.

Any error-based status messages that is based on a per time interval cause the status to show faulty until the entire sample interval has passed.

If the switch status is marginal or critical, information on the trigger that caused that status displays in the **Switch Information** view.

Click the **Status** button to display a detailed, customizable switch status report, shown in [Figure 31](#). Note that this is a static report and not a dynamic view of the switch.

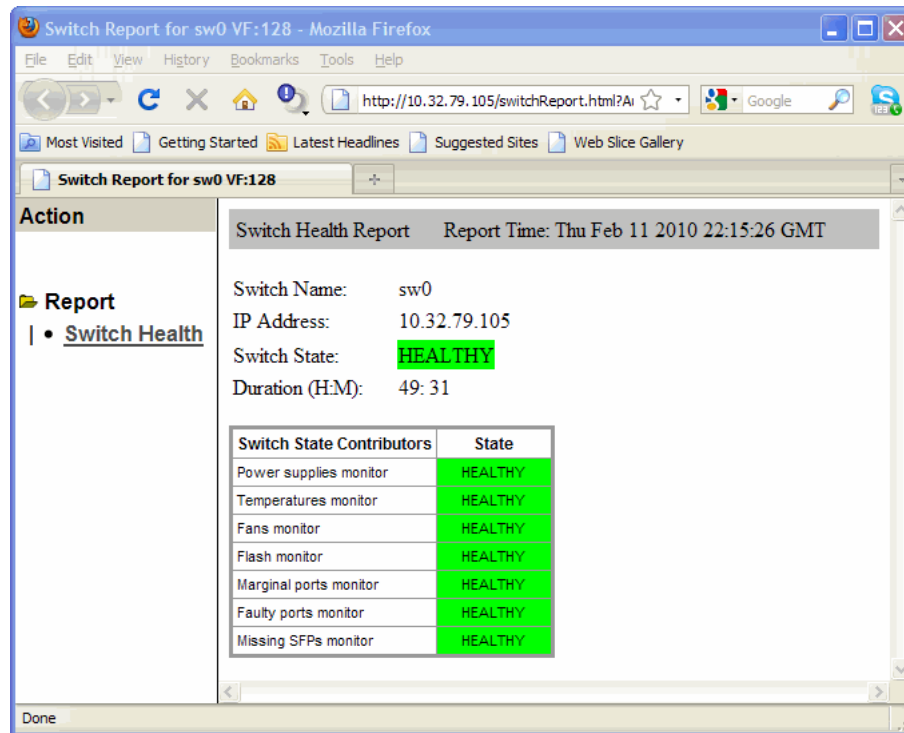

FIGURE 31 Switch Report window

To check the physical health of the switch, perform the following steps.

1. Select a logical switch from the **Logical Switch** drop-down list in the top-right corner of the **Switch Explorer** window.
 The selected switch displays in the **Switch View**. The icon on the **Status** button indicates the overall status of the switch.
2. Click **Status** on the **Switch View**.
 The detailed switch health report displays, as shown in [Figure 31](#).
3. *Optional:* Hold the cursor on the **Action** bar and click an action to perform one of the following options:
 - Refresh the information displayed in the report
 - Customize the report
 - View the data in raw XML format
 - View the style sheet for the report
 - View the XML schema for the report

Defining Switch Policy

The Switch Policy dialog box lets you define the values for what you consider a healthy switch. The parameters for Switch Policy define whether the unit is listed as being “Healthy”, “Marginal”, or “Down”.

Use this dialog box to set policy parameters for calculating the overall status of the switch. The policy parameter values determine how many failed or faulty units of each contributor are allowed before triggering a status change in the switch from “Healthy” to “Marginal” or “Down”. The existence of policies such as WWN, CP, and Blade might differ from platform to platform. Numerical and percentage values that are above “Marginal” are considered to be “Healthy.”

Any single contributor can force the overall status of the switch to “Marginal” or “Down”. For example, assuming that the switch contributor values are set to the default values, if there is one faulty port in a switch, then this contributor would set the overall switch status to “Marginal”. If two ports were faulty, then this contributor would set the overall switch status to “Down”.

Percentages are configured from a maximum of 100%. For example, setting the **Marginal** value to 6 means the percentage is 94% and up; setting the **Marginal** value to 12 means the percentage is 88% and up.

NOTE

Entering the value zero (0) for a parameter means that it is NOT used in the calculation. In addition, if the range of configurable values in the prompt is zero (0..0), the policy parameter is NOT applicable to the switch.

To define the Switch Status Policy, perform the following steps.

1. Open the Web Tools main page.
2. Click **Configure > Switch Status Policy**.

The **Switch Status Policy** dialog box displays, as shown in [Figure 32](#).

NOTE

The options available in the dialog box may differ, depending on the options available on your switch, including CP, core blades, blades, and WWN.

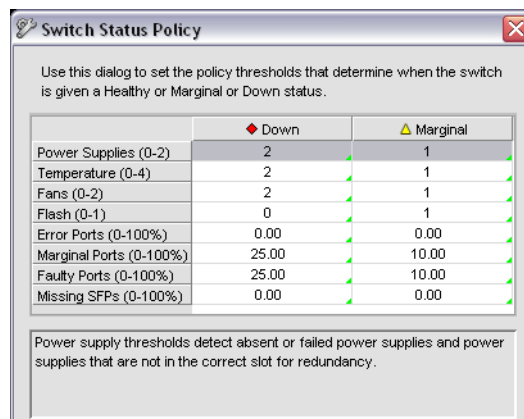

FIGURE 32 Switch Status Policy dialog box

3. Configure the numerical and percentage values to conform to your definition of a healthy switch.

For the selected row, the corresponding field description is displayed in the panel below.

4. Click **OK**.

Port LED interpretation

The [Switch View](#) displays port graphics with blinking LEDs, simulating the physical appearance of the ports. One of the LEDs indicates port status; the other indicates port speed. For LED information, refer to the hardware documentation for the switch you are viewing. (The blink rate of the LEDs in the **Switch View** does not necessarily match the blink rate of the LEDs on the physical switch.)

NOTE

All 8G and 16G Brocade switches and port blades do not have port speed LEDs, but only port status LEDs.

Port icon colors

The background color of the port icon indicates the port status, as follows:

- Green (healthy)
- Yellow (marginal)
- Red (critical)
- Gray (unmonitored)
- Blue (buffer-limited)
- Dimmed (unlicensed)

Using the FC-FC Routing Service

In this chapter

- [Fibre Channel Routing overview](#) 131
- [Supported switches for Fibre Channel Routing](#) 132
- [Setting up FC-FC routing](#) 132
- [FC-FC routing management](#) 133
- [Viewing EX-Ports](#) 134
- [Configuring an EX-Port](#) 135
- [Configuring FCR router port cost](#) 136
- [Viewing LSAN zones](#) 136
- [Configuring the backbone fabric ID](#) 137

Fibre Channel Routing overview

Fibre Channel Routing (FCR) provides connectivity to devices in different fabrics without merging the fabrics.

For example, Fibre Channel Routing allows you to share tape drives across multiple fabrics without the administrative problems, such as change management, network management, scalability, reliability, availability, and serviceability that might result from merging the fabrics.

Fibre Channel Routing lets you create logical storage area networks (LSANs) that can span fabrics. These LSANs allow Fibre Channel zones to cross physical SAN boundaries without merging the fabrics while maintaining the access controls of zones.

Note the following terminology for Fibre Channel Routing:

backbone fabric	An FC Router can connect two edge fabrics; a backbone fabric connects FC Routers. The FC Router fabric is the backbone fabric. A backbone fabric consists of at least one FC Router and possibly a number of Fabric OS-based Fibre Channel switches. Initiators and targets in the edge fabric can communicate with devices in the backbone fabric through the FC Router.
edge fabric	A standard Fibre Channel fabric with targets and initiators connected through an FC Router to another Fibre Channel fabric.
EX-Port	A type of port that functions somewhat like an E_Port, but does not propagate fabric services or routing topology information from one fabric to another.
FC Router	A switch running FC-FC Routing Service.
interfabric link (IFL)	The link between an E_Port and an EX-Port, or a VE_Port and a VEX-Port.
metaSAN	The collection of all SANs interconnected with FC Routers.

10 Supported switches for Fibre Channel Routing

VEX-Port A virtual port that enables routing functionality through an FCIP tunnel. A VEX-Port is similar to an EX-Port.

A device is shared between:

- The backbone fabric and edge fabric 1
- Edge fabric 1 and edge fabric 2
- Edge fabric 2 and edge fabric 3

Supported switches for Fibre Channel Routing

The FC-FC Routing Service is supported only on the following switch models:

- Brocade VA-40FC
- Brocade 6510
- Brocade 6520
- Brocade 5100 and 5300 switches
- Brocade 7800 Extension Switch
- Brocade DCX and DCX-4S enterprise-class platforms, when configured with FR4-18i, FC8-16, FC8-32, FC8-48, FC8-64, FS8-18, or FX8-24 blades.
- Brocade DCX 8510-4 and DCX 8510-8, when configured with FC8-32E, FC8-48E, FC16-32 or FC16-48 blades.

Setting up FC-FC routing

The following procedure provides the basic steps for setting up FC-FC Routing using an FC Router.

1. Ensure that the backbone fabric ID of the FC Router is the same as that of other FC Routers in the backbone fabric. Refer to [“Configuring the backbone fabric ID”](#) on page 137.
2. On the FC Router, ensure that the ports to be configured as EX-Ports are either not connected or are disabled.
3. Configure EX-Ports by clicking the **EX-Ports** tab and then clicking **New**.

Follow the instructions in the wizard. Refer to [“Viewing EX-Ports”](#) on page 134.

4. Connect the cables from the EX-Ports on the FC Router to the edge fabrics, if they were not connected before.

NOTE

For a multi-FC Router backbone fabric, make sure that each FC Router is connected to a switch in the backbone fabric.

5. Configure LSAN zones on the fabrics that share devices.
Refer to [“Viewing LSAN zones”](#) on page 136.
6. View the information in the **EX-Ports**, **LSAN Fabrics**, **LSAN Zones**, and **LSAN Devices** tabs to make sure that your configuration succeeded.

FC-FC routing management

You can perform Fibre Channel Routing operations using Web Tools, Web Tools with the EGM license, and Integrated Routing license. You can manage FC-FC Routing through the FC Routing module. The FC Routing module has tabbed panes that display EX-Ports, LSAN fabrics, LSAN zones, LSAN devices, and general FCR information.

NOTE

From Fabric OS v7.0.1, Integrated Routing (IR) license is not required to configure a port as EX_Port with Brocade NOS mode.

The FC Routing module provides a dynamic display. Any changes in the FCR configuration on the switch are automatically updated in the FC Routing module within 30 to 90 seconds, depending on the network traffic. The last refresh time is displayed in the lower left corner of the subtabs.

The switch must be FC Router-capable, as described in [“Fibre Channel Routing overview”](#) on page 131.

The only things you need to configure on the FC Router are the EX-Ports and the backbone fabric ID. You configure LSAN zones on the fabrics from where devices need to be shared. You can configure LSAN zones on the backbone fabric to allow edge fabrics to share devices in the backbone fabric.

To modify the data, you must log in as switchadmin, fabricadmin, basicswitchadmin, operator, or any user-defined role configured with modify rights. If you log in as user, zoneadmin, or securityadmin, you can only view the data.

If the FC-FC Routing service is disabled, the LSAN zones, LSAN fabric, and devices tabs continue to display the existing entries, but display the entries related to the *backbone fabric* only. All of the EX-Ports are disabled and you cannot enable them until FC-FC routing is enabled.

Opening the FC Routing module

The **FCR** submenu under **Configure** launches the FC Routing module. This module is displayed only for the following switches:

- Brocade VA-40FC
- Brocade 6510
- Brocade 6520
- Brocade 5100 and 5300 switches, and the 7800 Extension Switch.
- Brocade DCX and DCX-4S enterprise-class platforms, when configured with FR4-18i, FC8-16, FX8-24, FC8-32, FC8-48, FC8-64, FC16-32, or FC16-48 blades.
- Brocade DCX 8510-4 and DCX 8510-8, when configured with FC8-32E or FC8-48E blades.

NOTE

When the Virtual Fabrics capability is enabled on the switch, Fabric ID cannot be set using the **Set Fabric ID** button.

To open the FC Routing module, perform the following steps.

1. Select a logical switch from the **Logical Switch** drop-down list in the top-right corner of the **Switch Explorer** window.
The selected switch displays in the **Switch View**.
2. Click **Configure > FCR**.
The FC Routing module displays. If FC-FC Routing is disabled, a message to that effect displays on all the tabs in the module.

Viewing and managing LSAN fabrics

The **LSAN Fabric** tab displays all the LSAN fabrics visible to your switch, in both a tabular and tree form. (If FC-FC Routing is disabled, the table and tree nodes in this tab are empty and the tree displays only the backbone switch.)

For more detailed information about a specific LSAN fabric, click a fabric name in the table and then click **View Details** in the task bar. You can also click the fabric name in the tree on the left side of the window.

When there is more than one router present in the backbone fabric with different backbone Fabric IDs, the routers with the conflicting IDs are shown in a separate table on the LSAN Fabric tab.

To manage an LSAN fabric, select the fabric to manage and click **Manage LSAN Fabric** in the task bar. A browser window is launched with the following URL:

<http://ip-address-of-lsan-fabric-switch>

For Brocade switches, this launches Web Tools. For non-Brocade fabrics, this launches the Element Manager for that switch.

Viewing EX-Ports

The **EX-Ports** tab displays all of the EX-Ports on the switch, including configuration and status information. The ports are sorted by slot number, and then by row number within each slot. IP address information is displayed in IPv4 and IPv6 formats.

NOTE

To disable FC Routing, you must disable all EX/VEX ports. You cannot enable these ports until FC Routing is enabled.

For more detailed information about a specific port, click a port name in the table, and then click **View Details** in the task bar. You can also click the port name in the tree on the left side of the window.

From the **EX-Ports** tab, you can perform the following port management tasks by selecting a port in the table, and then clicking a task in the task bar:

- Configure EX-Ports
- Edit an EX-Ports configuration
- Rename an EX-Port
- Swap the Port Index of an EX-Port (described in “[Port swapping index](#)” on page 74)
- Enable or disable an EX-Port
- Persistently enable or disable an EX-Port

- Enable or disable trunking
- Configure router port cost

ATTENTION

During EX-Port configuration, the port is automatically disabled, and then re-enabled when the changes are applied. Be sure that you do not physically connect a port to a remote fabric before configuring it as an EX-Port; otherwise, the two fabrics merge and you lose the benefit of Fibre Channel Routing.

You can enable or disable multiple ports at one time. Use Shift-click and Ctrl-click to select multiple ports in the table, and then click one of the enable or disable tasks in the task bar.

You can select multiple ports in the table, but you can select only one port at a time in the tree.

Configuring an EX-Port

NOTE

With Fabric OS v7.0.1, Web Tools supports interoperability between a Fabric OS fabric and a Brocade Network OS fabric through an FC router. You can select this interoperability mode in the FC Port Configuration Wizard.

To configure an EX-Port, perform the following steps.

1. Select **Configure > FCR**.
2. Select the **EX-Ports** tab.
3. Click **New** in the task bar to configure one or more EX-Ports.

This launches the port configuration wizard, which guides you through the port configuration process.

You must specify the Fabric ID and, if configuring an FC port, the speed and long distance mode. You can select any unique fabric ID as long as it is consistent for all EX-Ports that connect to the same edge fabric.

Editing the configuration of an EX-Port

To edit the configuration of an EX-Port, perform the following steps.

1. Select **Configure > FCR**.
2. Select the **EX-Ports** tab.
3. Select a port to configure, by clicking the row.
4. Click **Edit Configuration** in the task bar. This launches the port configuration wizard, which guides you through the port configuration process. The current configuration values are displayed in the wizard steps.

NOTE

If you decide to configure a disabled port, the wizard provides the **Enable Port after configuration** check box. If you select this check box, the disabled port is automatically enabled after configuration. If you leave this box cleared, the port remains in the same state after configuration.

Configuring FCR router port cost

In FCR, EX-Ports can be assigned router port cost. The cost of the link is a positive number. The router port path or tunnel path is chosen based on the minimum cost per connection. If multiple paths exist with the same minimum cost, there will be load sharing over these paths. If multiple paths exist where one path costs lower than the others, then the lowest cost path is used.

Every link has a default cost. For an EX-Port 1 Gbps, 2 Gbps, 4 Gbps, 8 Gbps, 10 Gbps, and 16 Gbps links, the default cost is 1000. For a VEX-Port, the default cost is 10000. If the cost is set to 0, the default cost are be used for that link.

To configure the FCR router port cost, perform the following steps.

1. Click **Configure > FCR**.
2. Click the **EX-Ports** tab.
3. Disable the EX-Port.
4. Click the **Router Port Cost** button.

Viewing LSAN zones

The **LSAN Zones** tab displays all the LSAN zones, in both a tabular and tree form. If FC-FC Routing is disabled, the table and the tree node in this tab display only the LSAN zones present in the backbone fabric.

For more detailed information about a specific LSAN zone, click a zone name in the table and then click the **View Details** button in the task bar. You can also click the zone name in the tree on the left side of the window.

The LSAN matrix is mapping of LSAN Zones with the edge fabric they are going to communicate with. When an LSAN matrix is created in the backbone fabric, only the LSAN zones mapped in the edge fabrics are displayed in the LSAN Zones tab.

Follow the procedure described in [“Creating and populating zones”](#) on page 111 to create LSAN zones.

Viewing LSAN devices

The **LSAN Devices** tab displays information about the physical and proxy devices and displays these devices in a tree on the left side of the window. (If FC-FC Routing is disabled, the tables and tree nodes in this tab are empty.)

Click the **LSAN Devices** element in the tree to display a count of all the physical and proxy LSAN devices. Note that this count is for all of the LSAN fabrics.

Click the **Physical Devices** or **Proxy Devices** element in the tree to see a detailed list of the physical or proxy devices. Click the device name in the tree for more detailed information about a specific device.

Configuring the backbone fabric ID

Web Tools automatically disables FC-FC Routing before setting the fabric ID. You should manually enable FCR after setting backbone FID. However, you must first disable all of the EX-Ports before you begin this operation. After the fabric ID is changed, you must re-enable these ports.

NOTE

When the Virtual Fabrics capability is enabled on the switch, Fabric ID cannot be set using the **Set Fabric ID** button.

To configure the backbone fabric ID, perform the following steps.

1. Select **Configure > FCR**.
2. Select the **EX-Ports** tab.
3. Select all the EX-Ports in the table, and click **Disable**.
4. Select the **General** tab.
5. Click **Set Fabric ID** in the task bar.

The **Configure Backbone Fabric ID** window displays.

6. Select a fabric ID from the drop-down menu.

NOTE

The fabric ID is a number from 1 through 128. Web Tools warns you if you select a fabric ID that is already in use.

7. Click **OK**.
8. Click **Enable FCR** in the task bar.
9. Select all the EX-Ports in the table, and click **Enable**.

10 Configuring the backbone fabric ID

Using the Access Gateway

In this chapter

- [Access Gateway overview](#) 139
- [Viewing Switch Explorer for Access Gateway mode](#) 139
- [Access Gateway mode](#) 140
- [Enabling Access Gateway mode](#) 141
- [Disabling Access Gateway mode](#) 142
- [Viewing the Access Gateway settings](#) 142
- [Port configuration](#) 142
- [Access Gateway policy modification](#) 146
- [Access Gateway limitations on the Brocade 8000](#) 148

Access Gateway overview

Access Gateway is a software feature that allows multiple host bus adapters (HBAs) to access the fabric using fewer physical ports. You can set a switch in Access Gateway mode to transform them into a device management tool that is compatible with different types of fabrics, including Brocade Enterprise OS (EOS), and Cisco-based fabrics.

When a switch is in Access Gateway mode, it is logically transparent to the host and the fabric. Brocade Access Gateway mode allows hosts to access the fabric without increasing the number of switches and simplifies configuration and management in a large fabric by reducing the number of domain IDs and ports.

For detailed descriptions of the Access Gateway, refer to the *Brocade Access Gateway Administrator's Guide*.

NOTE

When Access Gateway mode is enabled on switches managed through Web Tools, only a limited subset of menus and options related to device management are available. A switch in Access Gateway mode is considered a device management tool and not a fabric switch, therefore fabric related options are disabled, fabric management menus are unavailable, and fabric-related service requests are forwarded to the fabric switches.

Viewing Switch Explorer for Access Gateway mode

The **Switch Explorer** for Access Gateway mode displays as shown in [Figure 33](#).

11 Access Gateway mode

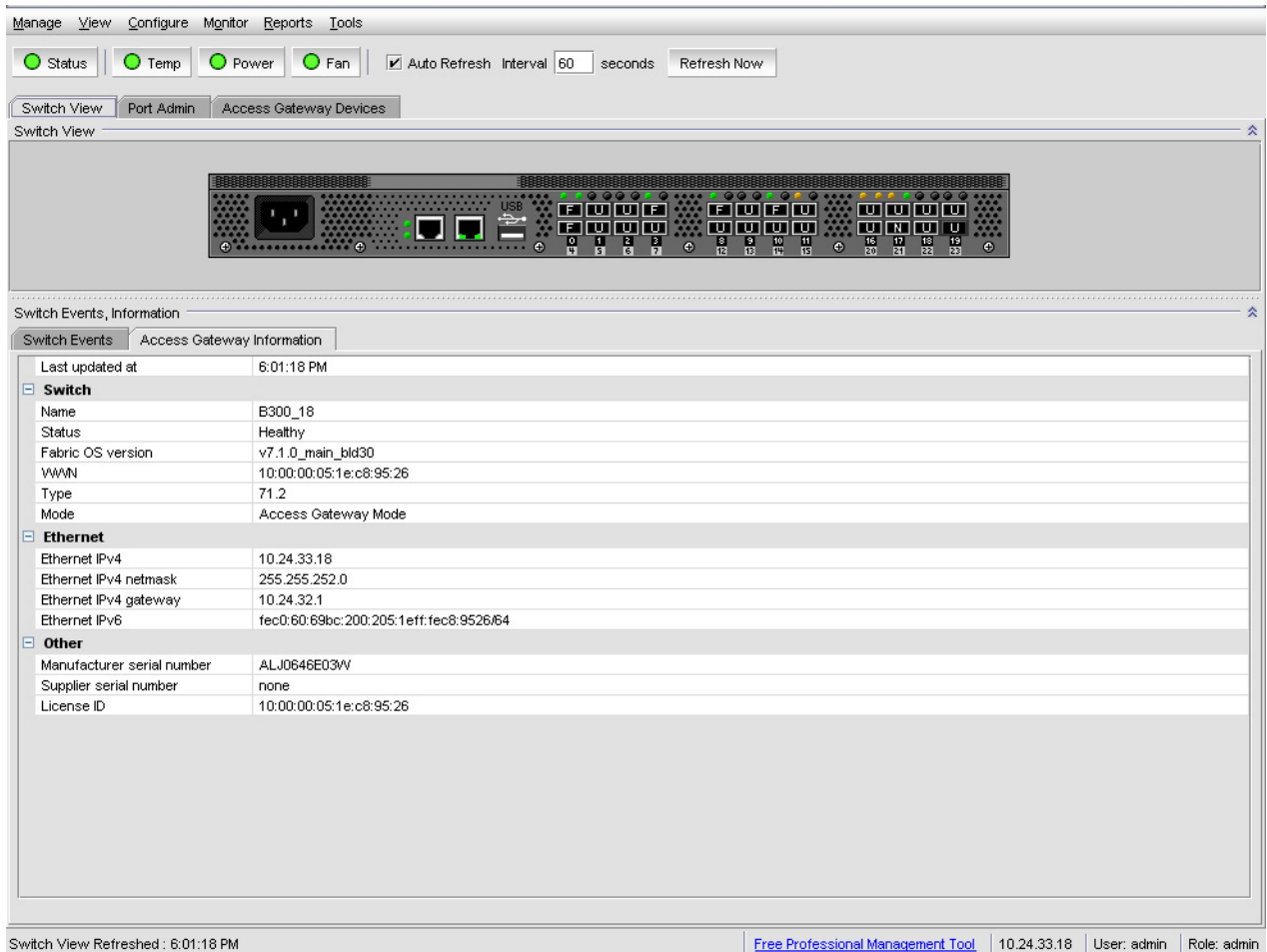

FIGURE 33 Switch Explorer view for Access Gateway mode

The Access Gateway mode **Switch Explorer** is divided into the following areas:

- Menu bar
- **Switch View** buttons
- **Switch View**, **Port Admin**, and **Access Gateway Devices** tabs
- **Switch Events** and **Access Gateway** information
- Indicator bar
- Professional Management Tool offering

Access Gateway mode

The Access Gateway feature on the Brocade Encryption switch and the Brocade 8000 enables interoperability with the Cisco fabrics. The Access Gateway mode of the switch presents standard F_Ports to the hosts, but it connects to the Enterprise fabric as N_Port (rather than as E_Port in case of a regular switch).

Restricted access in the Port Admin tab

When Access Gateway mode is enabled, the following options can be configured in access gateway mode:

- **Port Configuration Policy** – You can select Auto or Advanced mode (default mode). When auto mode is selected, options like Trunking, Configure N-Port Groups, Configure F-N Port Mappings, and N Port configuration are disabled.
- **Trunking** – Enabling and Disabling of N_Port trunking is disabled.
- **Configure N-Port Groups** – You can only view the port group details from the Port Group Configuration window. The following options are disabled:
 - Disable N-port Grouping
 - Add
 - Edit/View
 - Delete
- **Configure F-N Port Mappings** – Add and Remove buttons are disabled for primary mappings and secondary failover mapping.
- **N Port Configuration** – By default all the ports are set to N_Ports and failover and fallback are disabled. You can edit the speed. The following options are disabled in the N Port Configuration window:
 - Lock as N Port
 - Allow as F, U Port
 - Enable N Port Failover Policy
 - Enable N Port Fallback Policy

Enabling Access Gateway mode

When you enable Access Gateway mode some fabric information, such as the zone and security databases, is erased. To recover this information, save the switch configuration before enabling Access Gateway mode.

To save the switch configuration using Web Tools, in the **Switch Explorer** window click **Configure > Switch Admin**, and then select the **Configure > Upload/Download** subtab and upload the configuration file.

NOTE

You cannot enable Access Gateway mode if Management Server is enabled. To disable Management Server, enter the **MspmgmtDeactivate** command.

To enable Access Gateway mode, perform the following steps.

1. Select a switch.
2. Click **Configure > Switch Admin**.
The **Switch Administration** dialog box displays.
3. Click **Disable** in the **Switch Status** section.

You can enable Access Gateway mode only after the switch is disabled.

11 Disabling Access Gateway mode

4. Click **Enable** in the **Access Gateway Mode** section.
5. Click **Apply**.
6. Click **Yes** to restart the switch in Access Gateway mode.

Disabling Access Gateway mode

To disable Access Gateway mode, perform the following steps.

1. Select a switch.
2. Click **Configure > Switch Admin**.
The **Switch Administration** dialog box displays.
3. Click **Disable** in the **Switch Status** section. You can disable Access Gateway mode only after the switch is disabled.
4. Click **Disable** in the **Access Gateway Mode** section.
5. Click **Apply**.
6. Click **Yes** to restart the device in native switch mode.

Viewing the Access Gateway settings

You can view the effective Access Gateway settings for the selected switch. The view can be customized. To view the Access Gateway settings select the **Access Gateway Devices** tab.

Port configuration

You can configure the port types (N_Port, F_Port) on each individual port on an Access Gateway enabled switch. When you configure ports, you can specify a global configuration policy using the **Port Configuration Policy** button. By default, **Advanced** is selected and sets the initial defaults for port types, groups, and the F_Port-to-N_Port mappings. When the policy is **Automatic**, the port type assignments and mappings are configured automatically based on device and switch connections and internal load-balancing and grouping; user controls are disabled.

When you configure ports, perform the tasks in the following order:

1. Configure N_Ports, if necessary. Use the **Edit Configuration** button to configure a port.
2. Configure N_Port groups.
3. Configure F_Port-to-N_Port mappings. You can set up primary and secondary mappings. The secondary mapping is the N_Port to which an F_Port is mapped when the primary N_Port mapping goes offline.
4. Configure WWN-N_Port mappings

Creating port groups

You can group a number of N_Ports (and its mapped F_Ports) together to connect to multiple independent fabrics or to create performance optimized ports. To group a number of ports, you must create a new port group and assign desired N_Ports to it. The N_Port grouping option is enabled by default, and all N_Ports are members of a default port group 0 (pg0). Access Gateway prevents failover of F_Ports across N_Port groups.

NOTE

If you want to distribute F_Ports among groups, you can leave all ports in the default port group 0, or you can disable N_Port grouping.

To create port groups, perform the following steps.

1. Click a port in the **Switch View** to open the **Port Admin** tab.
2. Make sure that you have selected **Advanced** from the **Port Configuration Policy** drop-down list.
3. Click **Configure N_Port Groups**.

NOTE

Configure N_Port Groups is disabled if you select **Automatic** from the **Port Configuration Policy** drop-down list.

4. In the **Port Group Configuration** dialog box, click **Add**.
The **Add Port Group** window displays.
5. Enter the ID for the new port group in the **Port Group ID*** field.
6. Enter the name for the new port group in the **Port Group Name** field.
7. Select the **Login Balancing** check box to enable login balance for the port group.
8. Select the **Fabric Name Monitoring** check box to manually configure the managed fabric name monitoring.
9. Under the **Select Members(N-Port)*** section, select the required ports you want to group.
10. Click **Save**.
11. Click **Close** on the **Port Group Configuration** dialog box.

Editing or viewing port groups

To edit port groups, perform the following steps.

1. Click a port in the **Switch View** to open the **Port Admin** tab.
2. Click **Configure N_Port Groups**.
3. On **Port Group Configuration** dialog box, select the group that you want to edit and then click **Edit/View**.
The **Edit/View Port Group** window displays.
4. Edit the name of the port group in the **Port Group Name** field.
5. Select the **Login Balancing** check box and the **Fabric Name Monitoring** check box if you want to enable these features. Clear the check boxes to disable these features.

11 Port configuration

Upon selecting the **Login Balancing** check box, the **F Port Auto Rebalancing** and **N-Port Auto Rebalancing** check boxes and **Manual Balancing** button become enabled.

6. Click **Failover Enable**.

A confirmation dialog box displays.

7. Click **Yes** to enable failover to all the ports in the port group or click **No** if you do not want to enable failover.

8. Click **Failover Disable**.

A confirmation dialog box displays. Click **Yes** to disable failover to all the ports in the port group or click **No** if you do want to disable failover.

9. Click **Failback Enable**.

A confirmation dialog box displays.

10. Click **Yes** to enable failback to all the ports in the port group or click **No** if you do not want to enable failback.

11. Click **Failback Disable**.

A confirmation dialog box displays. Click **Yes** to disable failback to all the ports in the port group or click **No** if you do not want to disable failback.

12. Under the **Select Members(N-Port)*** section, select the required ports you want to group and clear the check boxes for the ports you want to remove from the port group.

13. Click **Save**.

14. Click **Close** on the **Port Group Configuration** dialog box.

Deleting port groups

NOTE

You cannot delete the default port group 0 (pg0).

To delete port groups, perform the following steps.

1. Click a port in the **Switch View** to open the **Port Admin** tab.
2. Click **Configure N_Port Groups**.
3. In the **Port Group Configuration** dialog box, select the group that you want to delete and then click **Delete**. A confirmation dialog box displays.
4. Click **Yes** to confirm the action.
5. Click **Close**.

Defining custom primary F-N port mapping

To manually change primary F-N port mappings, perform the following steps.

1. Click a port in the **Switch View** to open the **Port Admin** tab.
2. Click the **FC Ports** tab.
3. Click **Configure F_N Port Mappings**.

4. Select the **Primary Mappings** subtab on the right side of the dialog.
5. In the **Primary Mappings** area, select ports and use the **Add** (right arrow) button to map F_Ports or U_Ports to N_Ports.
6. *Optional:* Use the **Remove** (left arrow) button to delete an F_Port mapping from an N_Port.
7. *Optional:* Define a secondary N_Port in the **Secondary Failover Mappings** area, by selecting the ports using the **Add** and **Remove** buttons to set up the secondary mappings.

The secondary mappings must be to a different port in the same group as the primary mapping. If a secondary port is not defined, the failover moves to any online ports within the same port group.

8. After you have made the appropriate changes, click **Save**.

Defining custom static F-N port mapping

In Fabric OS v7.0.0, the **Static F port mapping** and **Static N port mapping** columns have been added to the **Port Admin** GUI to display static mapping information.

NOTE

Static mappings and custom WWN-N port mappings are mutually exclusive.

To manually change static F-N port mappings, perform the following steps.

1. Click a port in the **Switch View** to open the **Port Admin** tab.
2. Click the **FC Ports** tab.
3. Click **Configure F_N Port Mappings**.
4. Select the **Static Mappings** subtab on the right side of the dialog.
5. In the **Primary Mappings** area, select ports and use the **Add** (right arrow) button to map F_Ports or U_Ports to N_Ports.
6. *Optional:* Use the **Remove** (left arrow) button to delete an F_Port mapping from an N_Port.
7. After you have made the appropriate changes, click **Save**.

Defining custom WWN-N port mappings

NOTE

Static mappings and custom WWN-N port mappings are mutually exclusive.

To manually change WWN-N port mappings, perform the following steps.

1. Select the **Port Admin** tab.
2. Click the **FC Ports** tab.
3. Click **Configure WWN-N Port Mappings**.
4. In the **Primary Mappings** area, select a WWN from the left pane and a group or port from the right pane.
5. Click the **Add** (right arrow) button to map the WWN to the port or port group.

11 Access Gateway policy modification

6. *Optional:* Expand the port in the right page and select the WWN and then use the **Remove** (left arrow) to remove the mapping.
7. *Optional:* Define a failover in the **Secondary Failover Mappings** area, by selecting the ports using the **Add** and **Remove** buttons to set up the secondary mappings.

The WWN fails over to the secondary mapping if the primary mapped port is offline. If a secondary port is not defined, the failover moves to any online ports.

8. *Optional:* To create a detached WWN-N port mapping, enter the WWN value into the **WWN** field and click **Add**.

The detached WWN port is now available for mapping.

9. After you have made the appropriate changes, click **Save**.

Any unused WWNs are discarded.

Access Gateway policy modification

Although you can control a number of policies on switches in Access Gateway mode, Web Tools only provides the ability to enable and disable the policies. For more information on these policies please refer to *Access Gateway Administrator's Guide*.

Path Failover and Failback policies

The Path Failover and Failback policies determine the behavior of the F_Port if the primary mapped N_Port they are mapped to goes offline or is disabled. The Path Failover and Failback policies are attributes of the N_Port. By default, the Path Failover and Failback policies are enabled for all N_Ports.

Modifying Path Failover and Failback policies

To modify Path Failover and Failback policies, perform the following steps.

1. Click a port in the **Switch View** to open the **Port Admin** tab.
2. Select the N_Port for which you want to modify the policy.
3. Click **Edit Configuration**.
4. Select the appropriate check box to modify the policy.
5. Click **Save**.

Enabling the Automatic Port Configuration policy

The Automatic Port Configuration (APC) policy is a global configuration policy for a switch in Access Gateway mode. By default, this policy is disabled. If you created an N_Port grouping and switching over to the automatic mode, those port groups are lost. After you enable the APC policy, you cannot define custom port type configurations, port mappings, Path Failover, and Failback settings.

NOTE

When port configuration is in auto mode, the **Configure N port groups**, **Configure F-N port mapping**, and **Configure WWN-N port mapping** buttons are disabled.

To enable auto rebalancing from the **Switch Administration** window, perform the following steps.

1. Click a port in the **Switch View** to open the **Port Admin** tab.
2. Select **Automatic** from the **Port Configuration Policy** drop-down list.

NOTE

When **Port Configuration Policy** is set to **Advanced**, you can enable the auto rebalancing options from the **Configure N_Port Groups** dialog box through the **Port Admin** tab.

3. Click **Yes** in the confirmation window.
4. In the **Switch Explorer** window, click **Configure > Switch Admin**. The **Switch Administration** window displays (Figure 34).

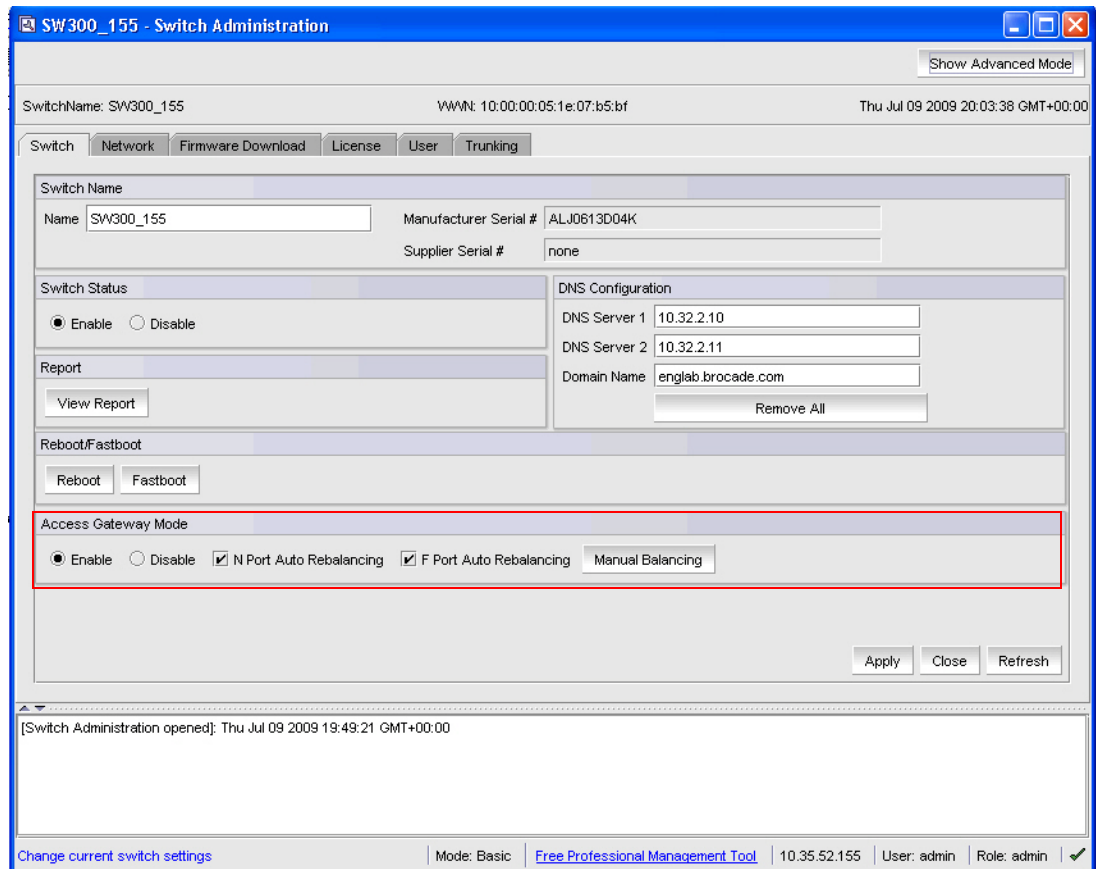

FIGURE 34 Access Gateway Auto Rebalancing

5. Click **Refresh**.
6. Under the **Access Gateway Mode** section, do the following:
 - Select the **N Port Auto Rebalancing** check box to enable N_Port rebalancing.
 - Select **F Port Auto Rebalancing** check box to enable F_Port rebalancing.

11 Access Gateway limitations on the Brocade 8000

- Click **Manual Balancing** and a confirmation dialog box displays. Click **Yes** to change F Port-N Port Mapping or click **No** to cancel the changes.
7. Click **Apply** to apply the changes.

Access Gateway limitations on the Brocade 8000

The following list the is a compilation of the limitations of using Access Gateway with the Brocade 8000 switch:

- Only the Port Grouping (PG) policy is supported. When the Access Gateway mode is first enabled, the default PG policy is enforced.
- When the Brocade 8000 runs in Access Gateway mode, all the FCoE ports are F_Ports and all the FC port are N-Ports.
- Static mapping is not supported on the Brocade 8000.
- When Access Gateway is enabled, F Ports mapping to N Ports is allowed and all 4 FCOE ports in the trunk group are mapped to the same N Port.
- F Ports mapping to the Port Group level is not allowed.
- You cannot map individual FCoE Ports within the same trunk group to different FC ports.
- All the four FCoE ports in a set will failover or failback to one FC N Port.
- Enabling or disabling of N-port Port Grouping is not allowed
- Port Group modification is allowed
- Login Balancing and Fabric Name Monitoring is not allowed in Add Port Group configuration.
- Login Balancing, Fabric Name Monitoring, F Port Auto Rebalancing, N Port Auto Rebalancing, and Manual Balance options are not allowed in the Edit Port Group or View Port Group configuration.

Administering Fabric Watch

In this chapter

- [Fabric Watch overview](#) 149

Fabric Watch overview

Fabric Watch is an optional Brocade licensed feature that monitors the performance and status of switches. Fabric Watch can automatically alert you when problems arise, before they become costly failures.

NOTE

If you do not own the switch, Fabric Watch is view-only. Owning ports on a switch is not enough to enable Fabric Watch on that switch.

To use Fabric Watch, you must have the Fabric Watch license installed on the switch.

Fabric Watch tracks a number of SAN fabric elements, events, and counters. For example, Fabric Watch monitors the following:

- Fabric resources, including fabric reconfigurations, zoning changes, new logins, domain ID changes, E-Port failures, and segmentation changes
- Switch environmental functions, such as temperature, flash , CPU and memory usage, along with security violations.
- Port state transitions, errors, and traffic information for multiple port classes as well as operational values for supported models of Finisar “Smart” GBICs/SFPs.

Fabric Watch lets you define how often to measure each switch and fabric element and allows you to specify notification thresholds. Whenever fabric elements exceed these thresholds, Fabric Watch automatically provides notification using several methods, including e-mail messages, SNMP traps, and log entries.

For detailed information regarding Fabric Watch, refer to the *Fabric Watch Administrator’s Guide*.

12 Fabric Watch overview

Administering Extended Fabrics

In this chapter

- [Extended link buffer allocation overview](#) 151
- [Configuring a port for long distance.](#) 154

Extended link buffer allocation overview

If the link is used over long distances, use the **Extended Fabric** tab of the **Switch Administration** window to configure the long-distance setting of a port. Because buffer credits are a switch resource, you must own the switch in order to modify extended fabric settings on a port. The EGM license must be enabled on the switch; otherwise, access to configuring long distance is denied and an error message displays.

The **Extended Fabric** tab displays information about the port speed, long-distance settings, and buffer credits, as shown in [Figure 35](#) on page 153. For detailed information on managing extended fabrics, refer to the *Fabric OS Administrator's Guide*.

The **Extended Fabric** tab displays the following columns:

- Port Number
- **Buffer Limited**—Indicates whether the port is buffer limited. A buffer-limited port can come online with fewer buffer credits allocated than its configuration specifies, allowing it to operate at a reduced bandwidth instead of being disabled for lack of buffers.

Buffer-limited operation is supported for the LS and LD extended ISL modes only and is persistent across reboots, switch disabling and enabling, and port disabling and enabling.

- **Port Speed**—The port speed is displayed as follows:
 - 1G—1 Gbps
 - 2G—2 Gbps
 - 4G—4 Gbps
 - 8G—8 Gbps
 - 10G—10 Gbps
 - N1—Negotiated 1 Gbps
 - N2—Negotiated 2 Gbps
 - N4—Negotiated 4 Gbps
 - N8—Negotiated 8 Gbps
 - N16—Negotiated 16 Gbps
 - Auto-Negotiation

- **Buffer Needed**—The number of buffers needed. You can edit the buffer needed for LD and LS modes. When you change **Buffer Needed** value, **Frame Size** and **Desired Distance(km)** value cannot be changed.
- **Buffer Allocated**—The number of buffers actually allocated.
- **Frame Size**—The size of the frame. When you edit the frame size value, the desired distance value can also be changed for LD and LS modes and vice versa. But the buffer value cannot be changed.
- **VC Link Init**—The fill words used on long distance links. When set to IDLE (0) mode, the link uses IDLE fill words. When set to ARB (1) mode, the link uses the default ARB fill words.
- **Fill Word**—Fill word comprises of the following modes:
 - **Mode 0:** Use IDLE in link init and IDLE as Fill word
 - **Mode 1:** Use ARB in link init and ARB as Fill word
 - **Mode 2:** Use IDLE in link init and ARB as Fill word
 - **Mode 3:** Try Mode 1 first; if it fails then try Mode 2.

NOTE

Fill word is not supported in 16 Gbps capable FC platforms.

You must configure **Fill Word** and then configure **Long Distance** and **VC Link Init**. Make sure **Fill Word** is always equal to or greater than the **VC Link Init** value.

- **Link Distance(km)**—The actual distance of the link.
- **Desired Distance (km)**—Required for a port configured in LD or LS mode ([Table 15](#) on page 153), the desired distance, in kilometers, for the link.

For an LD-mode link, the desired distance is used as the upper limit of the link distance to calculate buffer availability for other ports in the same port group. If the measured distance is more than the desired distance, the desired distance is used to allocate the buffers. In this case, the port operates in degraded mode instead being disabled due to insufficient buffers.

For an LS-mode link, the actual distance is not measured; instead the desired distance is used to calculate the buffers required for the port.

- **Long Distance**—[Table 15](#) describes the long-distance settings and identifies which settings require a Brocade Extended Fabrics license.

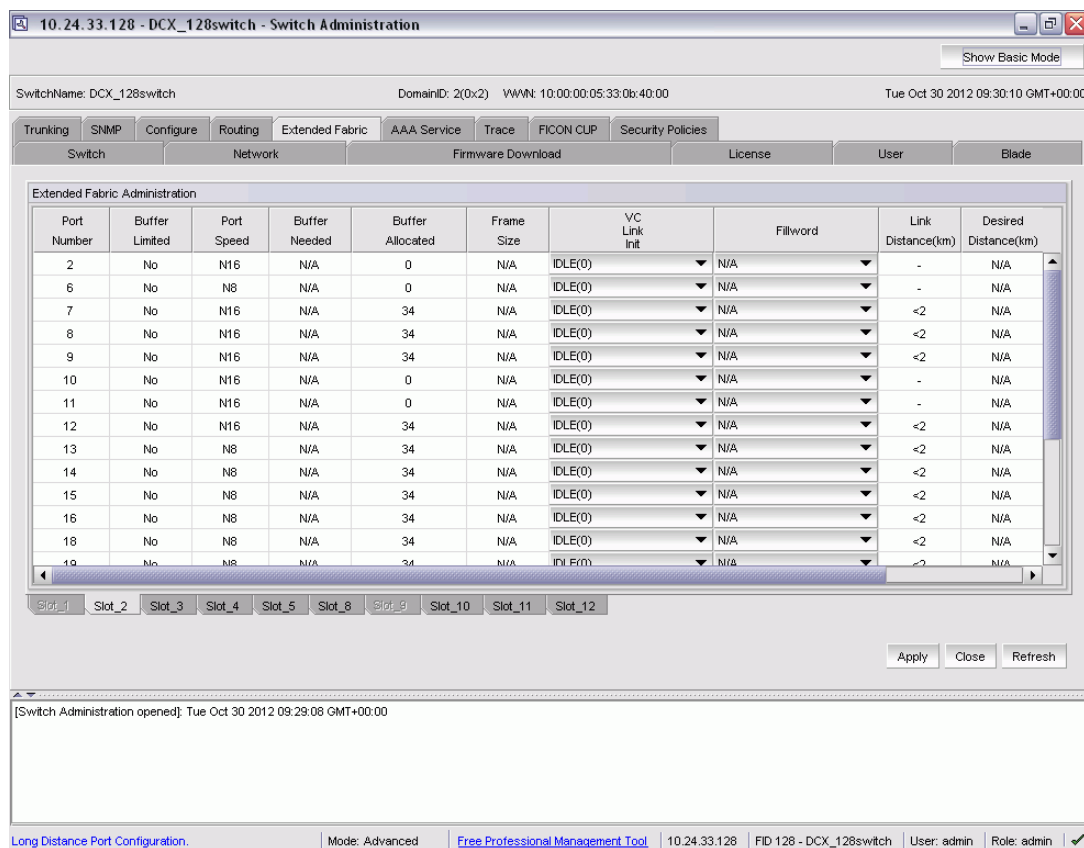

FIGURE 35 Extended Fabric tab

For the Brocade DCX, DCX-4S, DCX 8510-4, and DCX 8510-8 the slots for CPs are not available.

The Brocade Encryption Switch and the FS8-18 Encryption blade support auto-negotiated link speeds of 1, 2, 4, and 8 Gbps.

TABLE 15 Long-distance settings and license requirements

Value	Description	Extended Fabrics License Required?
LO	No long-distance setting is enabled. The maximum supported link distance is: <ul style="list-style-type: none"> • 10 kilometers at 1 Gbps • 5 kilometers at 2 Gbps • 2.5 kilometers at 4 Gbps • 1 kilometers at 10 Gbps • 500 meters at 16 Gbps 	No
LE	Extended normal setting is enabled, 10 km (6 miles) or less.	No

TABLE 15 Long-distance settings and license requirements (Continued)

Value	Description	Extended Fabrics License Required?
LD	Dynamic setting is enabled. Buffer credits for the given E_Port are dynamically configured based on the actual link distance, as long as this is less than the desired distance. If the actual link distance exceeds the desired distance, the desired distance is used to allocate the buffers. The LD-level link can operate at distances up to 500 km at 1 Gbps, 250 km at 2 Gbps, or 125 km at 4 Gbps, depending on the switch platform and the availability of frame buffers within the port group.	Yes
LS	Static setting is enabled. Buffer credits for the given E_Port are statically configured based on the desired link distance. The LS-level link can operate at distances up to 500 km at 1 Gbps, 250 km at 2 Gbps, or 125 km at 4 Gbit/sec, depending on the switch platform and the availability of frame buffers within the port group. For the Brocade DCX 8510-8, Brocade 6510, Brocade 6520, and Brocade DCX 8510-4, the buffer credits are 10 through X; where X is proportional to the available buffers.	Yes

Configuring a port for long distance

When you configure a long-distance ISL, ensure that the ports on both sides of the ISL have the same configuration in order to avoid fabric segmentation.

To configure a port for long distance, perform the following steps.

1. Open the **Switch Administration** window as described in “[Opening the Switch Administration window](#)” on page 31.
2. Click **Show Advanced Mode**.
3. Select the **Extended Fabric** tab.
4. This step is switch-specific:

For the Brocade 8510-8, 8510-4, DCX and DCX-4S platforms, click the slot subtab that corresponds to the correct slot for the logical switch.

For the Brocade 300, 5100, 5300, VA-40FC, 6505, 6510, 6520, 8000, 7800 Extension, and the Encryption Switch, proceed directly to the next step.

5. Select a distance that corresponds to the port from the **Long Distance** menu.

Depending on the distance selected, this might require a license. For information about the various distances, refer to [Table 15](#).

If you select a long-distance setting of LD or LS, you must also enter a value in the **Desired Distance** column for that port number. For LD or LS options, the **Buffer Needed** column is made editable to specify the buffer needed value. On changing the buffer needed value, the **Frame Size** and **Desired Distance** values cannot be changed.

- a. Double-click the **Desired Distance** field for the port, as shown in [Figure 35](#).
- b. Enter a number in the field to indicate the distance in kilometers. The allowed values depend on the port capability:
 - If the port capability is 8 GB, type a number between 10 and 63 inclusive.

- If the port capability is 4 GB, type a number between 10 and 125, inclusive.
- If the port capability is 2 GB, type a number between 10 and 250, inclusive.
- If the port capability is 1 GB, type a number between 10 and 500, inclusive.
- For the Brocade 6510, Brocade 6520, Brocade DCX 8510-8 and Brocade DCX 8510-4, the buffer credits are 10 through X; where X is proportional to the available buffers.

This value is the upper limit for calculating buffer availability for other ports in the same port group. If the actual distance is more than the desired distance, the port operates in buffer-limited mode.

- c. Press **Enter** or click another port entry for the value to be accepted.
6. Click **Apply**.
 7. Click **Yes** to apply the changes, or click **No** to close the confirmation message window.

13 Configuring a port for long distance

Routing Traffic

In this chapter

- [Routing overview](#) 157
- [Viewing fabric shortest path first routing](#) 158
- [Configuring dynamic load sharing](#) 159
- [Specifying frame order delivery](#) 160
- [Configuring the link cost for a port](#) 160

Routing overview

NOTE

To perform routing operations and Dynamic Load Sharing (DLS) configurations, the EGM license must be installed on the switch; otherwise, access to these features is denied and an error message displays.

For Fabric OS v7.0.0 and later, the supported routing policies are:

- **Port-Based-Routing** — Port-based routing assigns a “static route,” in which the path chosen for traffic never changes.
- **Exchanged-Based-Routing** — Exchange-based routing policy is the default. Exchange-based routing policy always employs “dynamic path selection,” in which the software defines a path based on current traffic conditions.
- **Device-Based-Routing** — Device-Based Routing (DBR) is a read only option. If DBR is set in the switch, then the DBR radio button appears auto-selected and grayed out in Web Tools.

Refer to the *Fabric OS Administrator’s Guide* for more information.

To optimize port-based routing, the DLS can be enabled to balance the load across the available output ports within a domain. Exchange-based routing *requires* the use of DLS; when this policy is in effect, you cannot disable the DLS feature.

Use the **Routing** tab of the **Switch Administration** window to view and modify routing information. [Figure 36](#) on page 158 displays the **Routing** tab.

14 Viewing fabric shortest path first routing

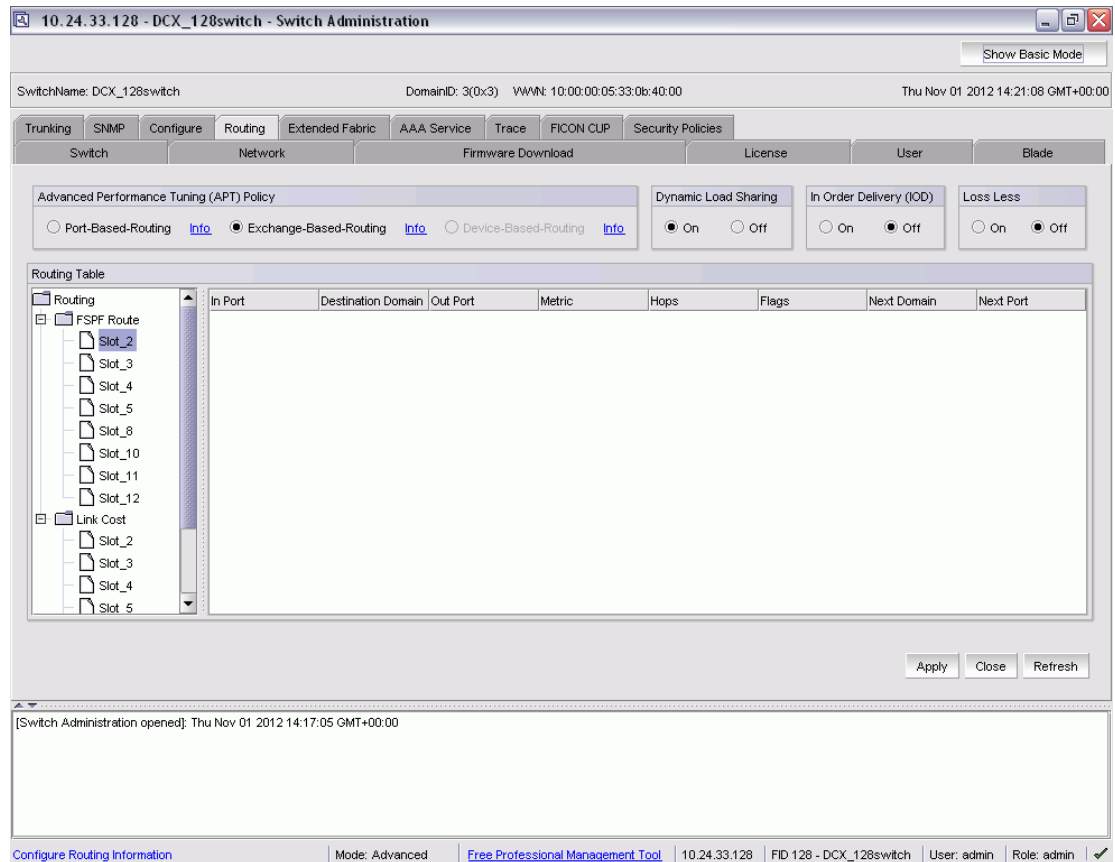

FIGURE 36 Routing tab

Viewing fabric shortest path first routing

The **Routing** tab of the **Switch Administration** window displays information about routing paths.

To view the fabric shortest path first routing, perform the following steps.

1. Open the **Switch Administration** window as described in “[Opening the Switch Administration window](#)” on page 31.
2. Select the **Routing** tab.
3. This step is switch-type specific:
 - For the Brocade DCX 8510-8, DCX 8510-4, DCX or DCX-4S enterprise-class platforms, click a slot number under the FSPF Route category in the navigation tree.
 - For the Brocade 300, 5100, 5300, 6505, 6510, 6520, 7800 Extension switches, VA-40FC, and the Encryption Switch, click the FSPF Route category in the navigation tree.

Configuring dynamic load sharing

The exchange-based routing policy depends on the Fabric OS dynamic load sharing feature (DLS) for dynamic routing path selection. When this policy is in force, DLS is always enabled and cannot be disabled.

When the port-based policy is in force, you can enable DLS to optimize routing. When DLS is enabled, it shares traffic among multiple equivalent paths between switches. DLS recomputes load sharing either when a switch boots up or each time an E_Port or FX_Port goes online or offline. Enabling this feature allows a path to be discovered automatically by the FSPF path-selection protocol.

For more information regarding DLS, refer to the **dlsset** command in the *Fabric OS Command Reference*.

To configure dynamic load sharing, perform the following steps.

1. Open the **Switch Administration** window as described in [“Opening the Switch Administration window”](#) on page 31.
2. Select the **Routing** tab.
3. Select **On** in the **Dynamic Load Sharing (DLS)** area to enable dynamic load sharing or select **Off** to disable dynamic load sharing.

When the exchange-based routing policy is in effect, the DLS radio buttons display on the **Routing** tab

4. Click **Apply**.

The warning message, “Credit Recovery for Long distance links should be turned off using CLI while enabling DLS” displays.

5. Click **OK**.

Lossless dynamic load sharing

Lossless dynamic load sharing (DLS) is supported in following platforms:

- Brocade FC16-32
- Brocade FC16-48
- Brocade DCX with 8G blades
- Brocade DCX-4S with 8G blades
- Brocade 300
- Brocade 5100
- Brocade 5300
- Brocade 6505
- Brocade 6510
- Brocade 6520
- Brocade 7800 on FC ports.
- Brocade FX8-24 on FC ports.

14 Specifying frame order delivery

You can enable this loss less feature from WT. If you try to enable loss less when DLS is OFF, an error message displays.

To enable or disable loss less DLS, perform the following steps.

1. Open the **Switch Administration** window as described in [“Opening the Switch Administration window”](#) on page 31.
2. Select the **Routing** tab.
3. Select **On** in the **Loss Less** area to enable the mode, or select **Off** to disable dynamic load sharing.

When the exchange-based routing policy is in effect, the Loss Less DLS radio buttons display on the **Routing** tab

4. Click **Apply**, and then click **OK**.

Specifying frame order delivery

In a stable fabric, frames are always delivered in order, even when the traffic between switches is shared among multiple paths. However, when topology changes occur in the fabric (for example, if a link goes down), traffic is rerouted around the failure, and some frames could be delivered out of order.

By default, frame delivery is out-of-order across topology changes. However, if the fabric contains destination devices that do not support out-of-order delivery, you can force in-order frame delivery across topology changes.

Enabling in-order delivery (IOD) guarantees that frames are either delivered in order or dropped. For more information regarding IOD, refer to the *Fabric OS Administrator’s Guide*.

NOTE

Enabling in-order delivery can cause a delay in the establishment of a new path when a topology change occurs, and therefore should be used with care.

To specify frame order delivery, perform the following steps.

1. Open the **Switch Administration** window as described in [“Opening the Switch Administration window”](#) on page 31.
2. Select the **Routing** tab.
3. Click **On** in the In Order Delivery (IOD) area to force in-order frame delivery across topology changes or click **Off** to restore out-of-order frame delivery across topology changes.
4. Click **Apply**.

Configuring the link cost for a port

This section describes how to set the cost of an interswitch link (ISL). The cost of a link is a dimensionless positive number. The fabric shortest path first (FSPF) protocol compares the cost of various paths between a source switch and a destination switch by adding the costs of all the ISLs along each path. FSPF defines the path with minimum cost. If multiple paths exist with the same minimum cost, FSPF employs load sharing over these paths.

Every ISL has a default cost that is inversely proportional to its bandwidth.

Use this procedure to set a non-default, “static” cost for any port.

1. Open the **Switch Administration** window as described in [“Opening the Switch Administration window”](#) on page 31.
2. Select the **Routing** tab.
3. This step is switch-specific:
 - For the Brocade DCX and DCX-4S enterprise-class platforms, click the slot number of the logical switch under **Link Cost** in the navigation tree.
 - For Brocade 300, 5100, 5300, 6505, 6510, 6520, 7800, VA-40FC, and the Encryption Switch, click **Link Cost** in the navigation tree.
4. Double-click in the row in the **Cost** column that corresponds to the appropriate port.
5. Enter the link cost. Valid values for link cost are from 1 through 65534. Setting the value to 0 sets the link cost to the default value for that port.
6. Click **Apply**.

14 Configuring the link cost for a port

Configuring Standard Security Features

In this chapter

- User-defined accounts 163
- User-defined roles 170
- Access control list policy configuration 173
- Fabric-Wide Consistency Policy configuration 177
- Authentication policy configuration 178
- SNMP configuration 180
- RADIUS management 182
- Active Directory service management 185
- TACACS+ management 187
- IPsec concepts 188
- IPsec over management ports 194
- Establishing authentication policies for HBAs 200

User-defined accounts

In addition to the default accounts—root, factory, admin, and user—Fabric OS v7.0.0 and later support up to 256 user-defined accounts in each logical switch (domain). These accounts expand your ability to track account access and audit administrative activities.

When the Virtual Fabrics capability is enabled, each user-defined account is associated with the following:

- Virtual Fabric ID—Specifies the accessible Virtual Fabrics for a user account.
- Home Virtual Fabric—Specifies the default Virtual Fabric for a user account.
- Role—Determines functional access levels within the Virtual Fabric.

Access rights for any user session are determined by the user's role-based access rights. Refer to [Chapter 1, "Introducing Web Tools"](#) for additional information about Role-Based Access Control (RBAC).

The **User** tab of the **Switch Administration** window (Figure 37 on page 165) displays account information. You can create and manage accounts depending on your role. The roles and permissions are listed in Table 16.

TABLE 16 User role and permissions

Role	Permissions
admin	Create and manage all predefined and user-defined accounts
operator	Change your own password and cannot create, modify, or view predefined or user-defined accounts
securityadmin	Create and manage all security roles.
switchadmin	Change your own password and cannot create, modify, or view predefined or user-defined accounts
zoneadmin	Change your own password and cannot create, modify, or view predefined or user-defined accounts
fabricadmin	Change your own password and cannot create, modify, or view predefined or user-defined accounts
basicswitchadmin	Change your own password and cannot create, modify, or view predefined or user-defined accounts
user	Change your own password and cannot create, modify, or view predefined or user-defined accounts

Virtual Fabrics considerations

If no home logical fabric ID is specified for a user, the system provides a default home ID. The default home ID is 128.

NOTE

The **User** tab displays and changes information in the switch database. If you have RADIUS configured, note that this tab displays the logged-in RADIUS account information but does not allow the user to modify the RADIUS host server database.

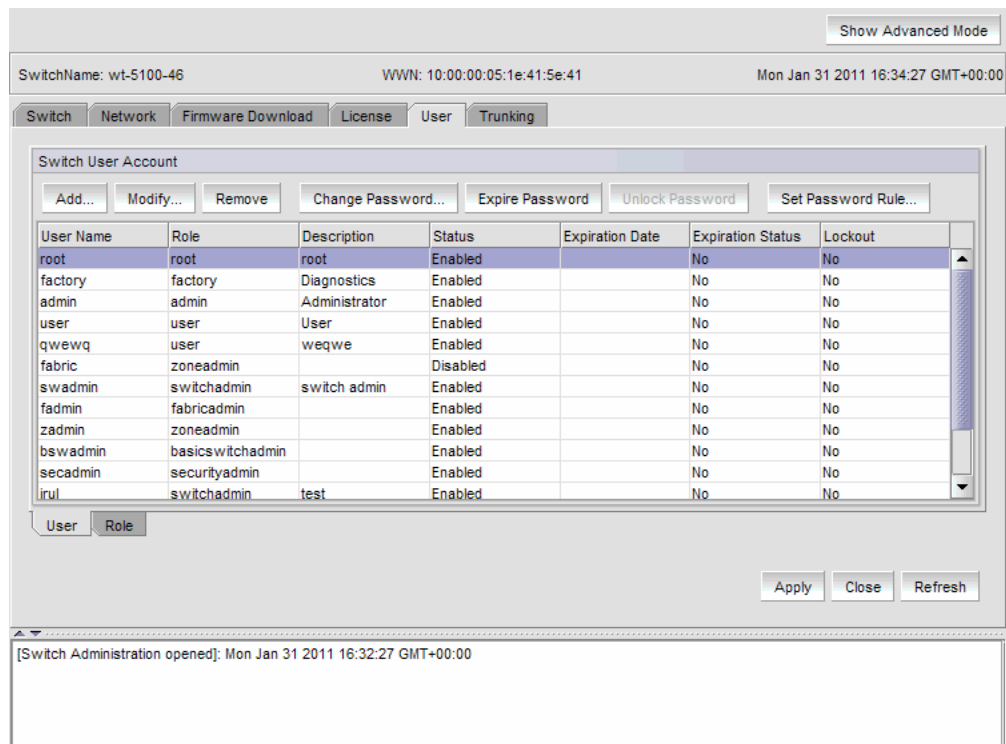

FIGURE 37 User tab

Viewing user account information

To view user account information, perform the following steps.

1. Open the **Switch Administration** window as described in [“Opening the Switch Administration window”](#) on page 31.
2. Select the **User** tab.

A list of the default and user-defined accounts displays. If you are logged in using the switchadmin role, only your account information displays.

Creating user-defined accounts

To create user-defined accounts, perform the following steps.

1. Open the **Switch Administration** window as described in [“Opening the Switch Administration window”](#) on page 31.
2. Select the **User** tab.
3. Click **Add**.

The **Add User Account** dialog box displays. For switches that support Virtual Fabrics, refer to [Figure 38](#).

Logical Fabric ID	User Role
1	No Access
2	No Access
3	No Access
4	No Access
5	No Access
6	No Access
7	No Access

FIGURE 38 Add User Account dialog box (VF)

4. Enter the user name.

The user name must begin with an alphabetic character. The name can be up to 40 characters long. It is case-sensitive and can contain alphabetic and numeric characters, the dot (.) and the underscore (_). It must be different from all other account names on the logical switch.

5. Select a role from the drop-down menu.

For VF-enabled switches, the selection is done per logical fabric ID. (Refer to [“Role-Based Access Control”](#) on page 13 for information about these roles.)

6. *Optional:* Enter a description of the account.
7. Click **Enabled** or **Disabled** to enable or disable the account.
8. Enter the password for the account.

The password is not displayed when you enter it on the command line. Passwords can be from 8 through 40 characters long. They must begin with an alphabetic or numeric character. They can include alphanumeric characters, the dot (.), and the underscore (_). They are case-sensitive.

Passwords must also meet any additional password rules that were set up. (Refer to the procedure [“Setting the rules for passwords”](#) on page 169 for more information.)

9. Retype the password in the **Confirm Password** field for confirmation.
10. Check the available Virtual Fabrics that you can access.

For Virtual Fabrics, all logical fabrics IDs (1-128) are displayed, even if they have not all been created.

The **All** button is disabled unless the following conditions are met:

- The selected role for the target user must be admin or securityadmin.
- You must be a physical fabric administrator.

Selecting **All** makes the target user account a physical fabric administrator.

11. Select a home logical fabric ID if Virtual Fabrics are enabled.

The default home logical fabric ID is 128.

12. For Virtual Fabrics environments, select a **Chassis Role**.

The chassis role determines the RBAC role and permissions of the user for performing all chassis-level operations in all logical fabrics.

13. Click **OK**.

14. On the **User** tab, click **Apply** to apply your changes.

Deleting user-defined accounts

To delete user-defined accounts, perform the following steps.

1. Open the **Switch Administration** window as described in “[Opening the Switch Administration window](#)” on page 31.
2. Select the **User** tab.
3. Select the account to remove and click **Remove**.
4. Click **Apply** to save your changes.

You cannot delete the default accounts. An account cannot delete itself. All active command line interface (CLI) sessions for the deleted account are logged out.

Changing user account parameters

You cannot change the user name of the account using this procedure. To change the user name, you must delete the account and create a new account.

Users can select their own accounts in the user account table and change the password. All other buttons are unavailable.

To change the user account parameters, perform the following steps.

1. Open the **Switch Administration** window as described in “[Opening the Switch Administration window](#)” on page 31.
2. Select the **User** tab.
3. Select the account to modify.

NOTE

You cannot modify the default root and factory accounts, even if you are logged in as root.

4. Click **Modify**.

The **Modify User Account** dialog box displays.

5. Select a role from the menu.

You can change the role only on user-level accounts. You cannot change the role on the admin or root accounts. You cannot change the role of your own account.

6. Enter a new description.

You can change the description only on user-level accounts. You cannot change the description of the default accounts. You cannot change the description of your own account.

7. Click **Enabled** or **Disabled** to enable or disable the account.

You can enable and disable user- and admin-level accounts, but not your own account. You cannot enable or disable your own account or the factory account. Only the root account can disable itself. If you disable an account, all active CLI sessions for that account are logged out.

The **All** button is disabled unless the following conditions are met:

- The selected role for the target user must be admin or securityadmin.
- You must be a physical fabric administrator.

Selecting **All** makes the target user account a physical fabric administrator.

8. Click **OK** and click **Apply** to apply your changes.

Maintaining passwords

When a password expires, the next time that user logs in, Web Tools requires the user to provide a new password.

NOTE

You have to own the switch in order to modify password rules.

A password becomes locked if a user has exceeded the maximum number of failed login attempts. This number is specified in the **Lockout Threshold** field. To unlock a locked password, refer to the unlock procedure in [“Unlocking a password”](#) on page 170.

Changing the password of an account

If you are logged in as admin, you can change the password of your own account, peer admin accounts, switchadmin accounts, and user accounts. You can also change the root or factory account passwords.

If you are changing the password of an admin account, you must also provide the current password. You do not need to provide the current password if you are changing the password of a lower-level user account.

Passwords can be from 8 through 40 characters long. They must begin with an alphabetic or numeric character. They can include alphanumeric characters, the dot (.), and the underscore (_). They are case-sensitive.

Passwords must also meet any additional password rules that were set up. (Refer to [“Setting the rules for passwords”](#) on page 169 for more information.)

To change the password of an account, perform the following steps.

1. Open the **Switch Administration** window as described in [“Opening the Switch Administration window”](#) on page 31.
2. Select the **User** tab.
3. Select the account to modify.

If you are logged in as a switchadmin, you can only change the password of your own account.

4. Click **Change Password**.

The **Set User Account Password** dialog box displays.

5. Enter the current password of the account.

This step is required only if you are changing the password of your own or a peer admin account.

6. Enter the new password of the account.

The new password must have at least one character different from the old password.

7. Retype the new password in the **Confirm Password** field.

8. Click **OK**.

9. Click **Apply** to save your changes.

Setting the rules for passwords

To set rules for passwords, perform the following steps.

1. Open the **Switch Administration** window as described in [“Opening the Switch Administration window”](#) on page 31.
2. Select the **User** tab.
3. Click **Set Password Rule**.

The **Configure Password Rule** dialog box displays.

4. Fill out the dialog box for the password rules you want to enforce.

The available options are:

- Minimum number of days (0–999) before you can change the password again
- Number of days (0–999) before a password expires
- Number of password changes before you can reuse a password
- Minimum password length (8–40 characters)
- Minimum number of uppercase and lowercase characters required
- Minimum number of digits and punctuation characters required
- Number of characters that can be repeated in the password
- Number of failed login attempts (0–999) before the password is locked from further change attempts, and the amount of time the password is locked (0–99999 minutes)
- Number of days to warn user before password expiration (0–999)

5. Select whether to enable or disable the lockout administration features.

If you select to disable the lockout administration, the user is never locked out of the system.

6. Click **OK** to close the dialog box.

7. Click **Apply** to save your changes.

Setting a password as expired

To set a password as expired, perform the following steps.

1. Open the **Switch Administration** window as described in [“Opening the Switch Administration window”](#) on page 31.
2. Select the **User** tab.
3. Select the account.
4. Click **Expire Password**.
If the button is unavailable, the password is already expired.
5. Click **Apply** to save your changes.

Unlocking a password

To unlock a password, perform the following steps.

1. Open the **Switch Administration** window as described in [“Opening the Switch Administration window”](#) on page 31.
2. Select the **User** tab.
3. Select the account.
4. Click **Unlock Password**.
If the button is unavailable, the password is already unlocked or was not locked out.
5. Click **Apply** to save your changes.

Displaying roles and assigned logical fabrics

You can display user role assignments for logical fabrics.

1. Open the **Switch Administration** window as described in [“Opening the Switch Administration window”](#) on page 31.
2. Select the **User** tab.
3. Select an account.
4. Select **Show Role and VF**. The role mapping for that user displays.

User-defined roles

User-defined role provides the ability to create roles dynamically on the switch. The default roles like Root, Factory, Admin, User, SwitchAdmin, ZoneAdmin, FabricAdmin, BasicSwitchAdmin, SecurityAdmin and Operator are defined by giving different permissions for different features, or by restricting access to various features. The default roles cannot be edited for assigning different privileges. However, user-defined roles provide the ability to create new roles and define permissions for the RBAC classes.

Guidelines and restrictions

Follow these guidelines and restrictions when creating and configuring user-defined roles:

- In order for the user-defined role to be able to edit the Port Admin and FCR configuration, you must assign the RBAC_SwitchPortManagement and RBAC_SwitchPortConfiguration RBAC classes to the role.
- In order for the user-defined role to be able to set the Fabric ID, you must assign the RBAC_FabricRouting and RBAC_SwitchConfiguration RBAC classes to the role.
- In order for the user-defined role to be able to view reports, you must assign the RBAC_SwitchManagement, RBAC_SwitchConfiguration and RBAC_FRUManagement RBAC classes to the role.

For some functionality and operations, which needs chassis level access, the user-defined role privileges must be assigned at both the chassis level and the Logical Fabric level to have the corresponding tab enabled:

- In order for the user-defined role to have access to the **Configure** tab, you must assign either the RBAC_ConfigManagement, RBAC_SwitchConfiguration, or RBAC_Configure classes to the user-defined role, which is applied at the Logical Fabric level. Any of these three classes are sufficient.
- In order for the user-defined role to have access to the **Security Policy** tab, you must assign either the RBAC_Authentication, RBAC_FabricDistribution, RBAC_Security, RBAC_IPSec, RBAC_AG, or RBAC_IPfilter classes to the user-defined role, which is applied at the Logical Fabric level. Any of these six classes is sufficient.
- In order for the user-defined role to have access to the **Switch** tab, you must assign either the RBAC_SwitchConfiguration, RBAC_SwitchManagement, RBAC_FRUManagement, RBAC_AG, or RBAC_Configure classes to the user-defined role, which is applied at the Logical Fabric level. Any of these five classes is sufficient.

Creating a user-defined role

To add a user-defined role, perform the following steps.

1. Open the **Switch Administration** window as described in [“Opening the Switch Administration window”](#) on page 31.
2. Select the **User** tab.
3. Select the **Role** sub-tab.
4. Click the **Add** button.

The **Switch Admin:Add User Defined Role** dialog displays.

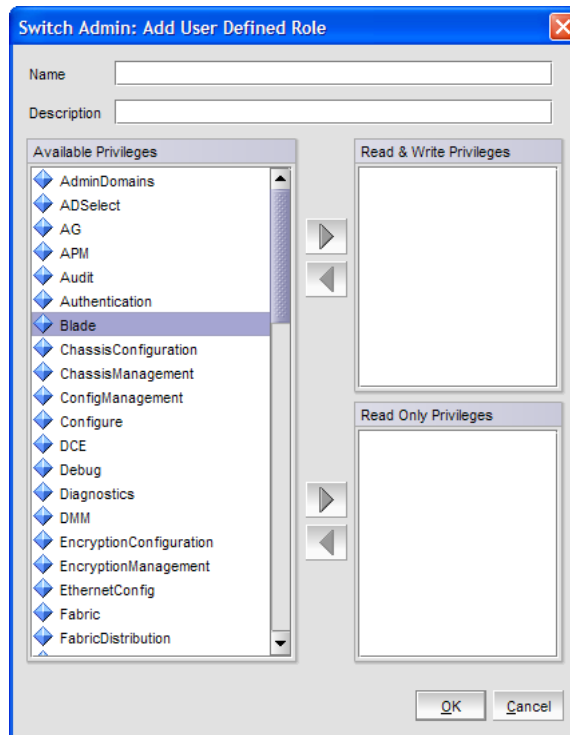

FIGURE 39 Switch Admin: Add User Defined Role dialog

5. Enter a role name in the **Name** field.
6. Enter a description of the role in the **Description** field.
7. To grant the role a read/write privilege, select the privilege and click the right-arrow next to the **Read & Write Privileges** section.

You can select multiple privileges.

8. To grant the role a read privilege, select the privilege and click the right-arrow next to the **Read Privileges** section.

You can select multiple privileges.

9. To delete a privilege, select it and click left-arrow.
10. Click **OK** to save your changes.

Editing a user-defined role

To edit a user-defined role, perform the following steps.

1. Open the **Switch Administration** window as described in [“Opening the Switch Administration window”](#) on page 31.
2. Select the **User** tab.
3. Select the **Role** sub-tab.
4. Select an existing user-defined role.
5. Click the **Edit** button.

The **Switch Admin:Edit User Defined Role** dialog box displays.

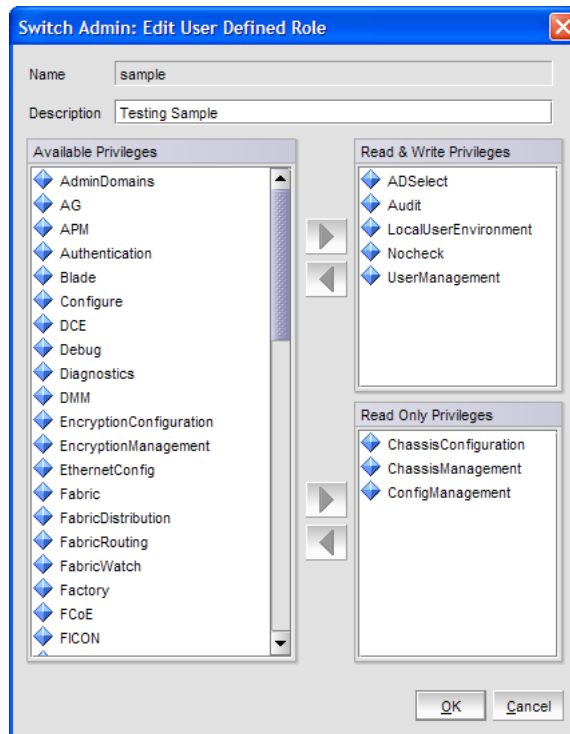

FIGURE 40 Switch Admin:Add User Defined Role dialog

6. To grant the role a read/write privilege, select the privilege and click the right-arrow next to the **Read & Write Privileges** section.
You can select multiple privileges.
7. To grant the role a read privilege, select the privilege and click the right-arrow next to the **Read Privileges** section.
You can select multiple privileges.
8. To delete a privilege, select it and click left-arrow.
9. Click **OK** to save your changes.

Access control list policy configuration

Support for the Access Control List (ACL) policies is currently defined in the Switch Connection Control (SCC) and Device Connection Control (DCC) policies. SCC and DCC policy configuration in base Fabric OS is performed on a switch-local basis.

Fabric Configuration Server (FCS) Policy can be created only once. While creating the FCS policy, the local switch WWN is automatically included in the list. In the FCS list, the switch in the first position becomes the primary FCS switch. If the first switch in the FCS list is not reachable, the next switch becomes the primary switch. You can also explicitly specify the primary FCS switch.

If there is no SCC, DCC, or FCS policy, the defined and active list is blank.

Virtual Fabrics considerations

ACL policies can be implemented at the logical switch/logical fabric level.

Creating an SCC, DCC, or FCS policy

You can create the FCS policy only once.

To create an SCC, DCC, or FCS policy, perform the following steps.

1. Open the **Switch Administration** window as described in [“Opening the Switch Administration window”](#) on page 31.
2. Select the **Security Policies** tab.
3. Select the **ACL** subtab.
4. Select a policy by clicking on the appropriate tab (**SCC**, **DCC**, or **FCS**).
5. Click **Edit**.
This launches the **ACL Policy Configuration** wizard.
6. Select the policy type you want to edit.
7. Click **Next** and click **Create**.
8. *SCC Option:* Add switches to an SCC policy by selecting one or more switches and clicking **Add** or **Add All**.
9. *SCC Option:* To add an offline switch, click **Add other Switch** and enter the WWN.
10. *DCC Option:* Select the ports to add to a DCC policy.
When you launch the **DCC Policy Configuration** wizard, only the launched switch and its ports are listed in the tree. All the devices in the fabric are also listed in the tree.
11. Click **OK** to confirm the changes to the switch.
12. Activate the policy in order to implement it. Refer to [“Activating all SCC, DCC, or FCS policies”](#) on page 175 for instructions.

Editing an SCC, DCC, or FCS policy

To edit an SCC, DCC, or FCS policy, perform the following steps.

1. Open the **Switch Administration** window as described in [“Opening the Switch Administration window”](#) on page 31.
2. Make sure the **Show Advanced Mode option** is selected.
3. Select the **Security Policies** tab.
4. Select a policy by clicking on the appropriate tab.
5. Click **Edit**.
This launches the **ACL Policy Configuration** wizard.
6. Select the policy type you want to edit.
7. Click **Next** and click **Modify**.

8. Select a switch or highlight multiple switches to add to the policy by clicking **Add** or **Add All**.
9. Select a switch or highlight multiple switches to remove a policy by clicking **Remove**.
10. Click **Next** and click **Finish** to confirm the changes to the switch.

Deleting all SCC, DCC, or FCS policies

You cannot delete the FCS policy from non-primary or non-FCS switches.

The **Delete All** button is enabled only when there is at least one policy activated.

To delete all SCC, DCC, or FCS policies, perform the following steps.

1. Open the **Switch Administration** window as described in [“Opening the Switch Administration window”](#) on page 31.
2. Select the **Security Policies** tab.
3. Click **Delete All**.
A warning message displays.
4. Click **OK** to delete all the policies.

Activating all SCC, DCC, or FCS policies

After a policy is created or modified, you can distribute it to the remaining fabric.

To delete a policy, you must activate a new or empty policy.

To activate all SCC, DCC, or FCS policies, perform the following steps.

1. Open the **Switch Administration** window as described in [“Opening the Switch Administration window”](#) on page 31.
2. Select the **Security Policies** tab.
3. Click **Activate All** to activate all the policies.

NOTE

Activating the policy moves it into the **Activate Policy Set** window.

Distributing an SCC, DCC, or FCS policy

Perform this procedure to distribute an SCC, DCC, or FCS policy.

NOTE

SCC and DCC policy can be distributed only for a primary switch.

To distribute an SCC, DCC, or FCS policy, perform the following steps.

1. Open the **Switch Administration** window as described in [“Opening the Switch Administration window”](#) on page 31.
2. Select the **Security Policies** tab.
3. Select the appropriate tab (**SCC**, **DCC**, or **FCS**).

4. Click **Distribute Policy**.
5. Select the switches that will receive the policy.
6. Select **OK**.

If the policy distribution fails, an error dialog box displays.

Moving an FCS policy switch position

You can move the position of a primary switch in the FCS policy list.

To move an FCS policy switch position, perform the following steps.

1. Open the **Switch Administration** window as described in [“Opening the Switch Administration window”](#) on page 31.
2. Click **Show Advanced Mode**.
3. Select the **Security Policies** tab.
4. Select the **FCS** tab.
5. Click **Move FCS Switch**.
6. Select the appropriate from and to positions.
7. Click **Apply**.
8. After you move all the member switches, click **Apply** and **Close**.

Configuring Advanced Device Security policy

The ADS policy allows you to restrict devices that are logged into the fabric using a particular F_Port. When this policy is enabled only authorized devices are allowed to login into the fabric. This can be achieved by allowing all the devices, blocking all the devices, or giving access to selected devices. ADS is supported only in Access Gateway mode.

The restrictions to device login are:

- **All Access**—Allows all the devices to login into the fabric through that F_Port.
- **No Access**—Blocks all the devices trying to login into the fabric through that F_Port.
- **WWNs**—Allows only selected WWNs to login into the fabric through that F_Port. NPIV capable device port WWN's can also be added to the allowed list of device port WWN's for the particular F_Port.

When the ADS policy is enabled first time, all the F_Ports are set to **All Access** and all the devices are allowed to login into fabric. This configuration persists for subsequent logins from all devices. Existing devices that are already logged into the fabric are not affected.

When the ADS policy is disabled, all the allowed lists are cleared and all the devices are allowed to login into the fabric.

To configure ADS policy, perform the following steps.

1. Open the **Switch Administration** window as described in [“Opening the Switch Administration window”](#) on page 31.
2. Click **Show Advanced Mode**.

3. Select the **Security Policies** tab to configure the ADS policy in Access Gateway mode.
4. Select the **ADS** option.
5. Select the **Enable ADS Policy** option.
The **Configure Advanced Device Security Port WWN** table displays.
6. *Optional:* Select an F_Port from the table and click the **Edit** button.
The **ADS Port WWN Configuration** dialog displays. You can configure device port WWN's that can be allowed to login to a particular F_Port by adding them to the **Selected WWN** list.
7. Select either **All Access**, or a list of selected WWNs.
8. *Optional:* You can add the detached port WWN to the selected WWN's list by adding the WWN in the **detached WWN** text field and clicking **Add**.
9. *Optional:* For a selected F Port, if you select the **Show device WWN connected to this port** check box of the **ADS Port WWN Configuration** dialog, only connected devices are listed in **Available WWN**'s list. When you deselects the check box, all the connected device port WWN's and detached WWN's added to the AG are listed in the **Available WWN**'s list.

Fabric-Wide Consistency Policy configuration

Fabric-Wide Consistency Policy (FWCP) configures the Fabric Wide Consistency behavior of distributable ACL policies. The policy ensures that the switches in the fabric enforce the same policies. Set a strict or tolerant fabric-wide consistency policy for each ACL policy type (SCC, DCC, FCS) to automatically distribute that database when a policy change is activated. If a fabric-wide consistency policy is not set, then the policies are managed on a per switch basis.

To set the fabric-wide consistency policy for an SCC, DCC or FCS policy, perform the following steps.

1. Open the **Switch Administration** window as described in [“Opening the Switch Administration window”](#) on page 31.
2. Select the **Security Policies** tab.
3. Under **Security Policies**, click **FWCP**.
4. Select one of the following consistency behavior for the required policy type (**SCC, DCC, FCS**).
 - Absent
 - Tolerant
 - Strict

NOTE

You can change the consistency behaviors of SCC, DCC, or FCS policy only for a primary switch.

5. Click **Apply**.
6. Click **Yes** to accept the changes.

NOTE

If the switch is not a primary switch, an error message dialog box displays.

7. Click **No** to discard the changes and click **Refresh** in the **FWCP Configuration** window to manually refresh the window.

8. Click **Close**.

Authentication policy configuration

You can configure an authentication protocol policy for E_Port and F_Port authentication, and then distribute the authentication policy to other switches in the fabric. You can also set shared secret keys.

Configuring authentication policies for E_Ports

To configure authentication policies for E_Ports, perform the following steps.

1. Open the **Switch Administration** window as described in “[Opening the Switch Administration window](#)” on page 31.
2. Select the **Security Policies** tab.
3. Select **Authentication** on the **Security Policies** menu.
4. In the **Authentication Type** field, select **FCAP** or **DHCHAP**.
5. Select the switch authentication policy mode:

On	Strict authentication is enforced on all E_Ports.
Active	The switches can be connected to a switch with any type of policy.
Passive	The switch does not initiate authentication but participates if the connecting switch initiates authentication.
Hash	A hash function (like SHA or MD5) is used for authentication.
Off	The switch does not support authentication. Any authentication negotiation is rejected.

6. Select a **DH-Group** type.
7. *Optional:* Set the **device authentication policy mode** to either **off** or **passive** and click **Apply**.

Configuring authentication policies for F_Ports

To configure authentication policies for F_Ports, perform the following steps.

1. Open the **Switch Administration** window and click **Show Advanced Mode**, if not selected.
2. Select the **Security Policies** tab.
3. Select **Authentication** on the **Security Policies** menu.
4. In the **Authentication Type** field, select **DHCHAP**.

NOTE

You must select **DHCHAP** when you are configuring authentication for an F_Port.

5. Set the **switch authentication mode** to either **off** or **passive** and click **Apply**.

Distributing authentication policies

Authentication policies are distributed only if all the selected switches accept the distribution. Only the policy mode is distributed to the selected switches. The switch initiating the distribution must accept distribution.

To distribute authentication policies, perform the following steps.

1. Open the **Switch Administration** window as described in [“Opening the Switch Administration window”](#) on page 31.
2. Select the **Security Policies** tab.
3. Select **Authentication** on the **Security Policies** menu.
4. Click **Distribute Policy**.
5. Select the switches or click the button to distribute to all.
6. Click **OK**.

Re-authenticating policies

A user who has changed authentication policy parameters or a shared secret key pair can re-initialize the authentication.

To re-authenticate policies, perform the following steps.

1. Click a port in the **Switch View** to open the **Port Admin** tab.
The **Port Admin** tab displays with the port selected.
2. Click **Re-Authenticate** (active only for F_Ports and E_Ports).
3. Close the window.

Setting a shared secret key pair

DH-CHAP requires a shared secret key pair between two entities to authenticate with each other. A key pair consists of a local secret and a peer secret. The local secret identifies the local switch. The peer secret identifies the entity to which the local switch may authenticate.

To set a shared secret key pair, perform the following steps.

1. Open the **Switch Administration** window as described in [“Opening the Switch Administration window”](#) on page 31.
2. Select the **Security Policies** tab.
3. Select **Authentication** on the **Security Policies** menu.
4. Select the **Shared Secret Keys** subtab.
5. Click **Add**.

The **Add Shared Secret Keys** dialog box displays.

6. Enter the Switch or HBA WWN, name, or domain ID, or use the **Browse** button to select a switch.
7. In the **Peer Secret** and **Confirm Peer Secret** fields, enter the peer secret value.
8. In the **Local Secret** and **Confirm Local Secret** fields, enter the local secret value.
9. Click **Add**.
10. When you are finished adding secret key pairs for switches, click **Apply**.

Modifying a shared secret key pair

You can edit and modify the secret key pairs by switch.

To modify a shared secret pair, perform the following steps.

1. Open the **Switch Administration** window as described in [“Opening the Switch Administration window”](#) on page 31.
2. Select the **Security Policies** tab.
3. Select **Authentication** on the **Security Policies** menu.
4. Select the **Shared Secret Keys** subtab.
5. Select a secret key pair and click **Edit**.
6. Make the appropriate changes and click **OK**.

Setting the Switch Policy Authentication mode

This setting determines whether or not authentication is required when a switch logs in to a fabric.

To set the Switch Policy Authentication mode, perform the following steps.

1. Open the **Switch Administration** window as described in [“Opening the Switch Administration window”](#) on page 31.
2. Select the **Security Policies** tab.
3. Select **Authentication** on the **Security Policies** menu.
4. Use the **Switch Policy Authentication Mode** option to select the authentication policy.

SNMP configuration

This section describes how to manage the configuration of the SNMP agent in the switch. The configuration includes SNMPv1 and SNMPv3 configuration, accessControl, and systemGroup configuration parameters.

Access is read-only if you do not have admin or security admin authority.

For more information, refer to the **snmpConfig** command in the *Fabric OS Command Reference*.

Setting SNMP trap levels

To set SNMP trap levels, perform the following steps.

1. Open the **Switch Administration** window as described in [“Opening the Switch Administration window”](#) on page 31.
2. Select the **SNMP** tab.
3. Select a trap level for a recipient from the corresponding **Trap Level** menu in the **SNMPv1** and **SNMPv3** sections.

The level you select identifies the minimum event level that prompts a trap.

NOTE

Adding or editing the user name can be done only through the CLI and by selecting a user name from the **User Name** menu in the **SNMPv3** section.

4. Click **Apply**.

Changing the systemGroup configuration parameters

To change the systemGroup configuration parameters, perform the following steps.

1. Open the **Switch Administration** window as described in [“Opening the Switch Administration window”](#) on page 31.
2. Select the **SNMP** tab.
3. Enter a contact name, description, and location in the **SNMP Information** section.
4. *Optional:* Select the **Enable Authentication Trap** check box to allow authentication traps to be sent to the reception IP address.
5. Click **Apply**.

Setting SNMPv1 configuration parameters

To set SNMPv1 configuration parameters, perform the following steps.

1. Open the **Switch Administration** window as described in [“Opening the Switch Administration window”](#) on page 31.
2. Select the **SNMP** tab.
3. Double-click a community string in the **SNMPv1** section and enter a new community string.
4. Double-click a recipient IP address in the **SNMPv1** section and enter a new IP address.
5. Click **Apply**.

Setting SNMPv3 configuration parameters

NOTE

The port number is not included.

To set SNMPv3 configuration parameters, perform the following steps.

1. Open the **Switch Administration** window as described in [“Opening the Switch Administration window”](#) on page 31.
2. Select the **SNMP** tab.

3. Select a user name from the **User Name** menu in the **SNMPv3** section.

NOTE

The list is scrollable. If you do not see your user name, scroll down using the scroll bar or by clicking the **User Name** heading.

4. Double-click a recipient IP address in the **SNMPv3** section and enter a new IP address.
5. Select a trap level from the **Trap Level** menu.
6. *Optional:* Select the **Enable SNMPv3 Informs for all Trap Recipients** check box to enable or disable inform requests for all trap recipients.
7. Enabling SNMPv3 informs allows you to enter the **Engine ID**.
The Engine ID is required to authenticate the inform request. If informs request is disabled, the SNMP manager does not send a response to the sender.
8. Click **Apply**.

Changing the access control configuration

NOTE

The port number is not included.

To change the access control configuration, perform the following steps.

1. Open the **Switch Administration** window as described in [“Opening the Switch Administration window”](#) on page 31.
2. Select the **SNMP** tab.
3. Double-click an access host IP address in the **Access Control List** section and enter a new host IP address. You can enter an IP address in either IPv4 or IPv6 format. When you use the IPv6 format, you must include a prefix; for example, `fec0::2002/64`.

NOTE

The list is scrollable. If you do not see your user name, scroll down using the scroll bar or by clicking the **Access Host** heading.

4. Select a permission for the host from the **Access Control List** menu.
Options are **Read Only** and **Read Write**.
5. Click **Apply**.

RADIUS management

Fabric OS supports RADIUS authentication, authorization, and accounting service (AAA). When configured for RADIUS, the switch becomes a Network Access Server (NAS) that acts as a RADIUS client. In this configuration, authentication records are stored in the RADIUS host server database. Login and logout account name, assigned role, and time accounting records are also stored on the RADIUS server.

You should set up RADIUS through a secure connection such as SSH.

The following are the three choices in the drop-down menu when RADIUS is selected as the primary service:

- **Switch Database when RADIUS Authentication Fails**—When selected, the switch user login database is checked whenever RADIUS authentication fails.
- **Switch Database When RADIUS Times Out**—Switch user login database is checked only if the physical connection to the RADIUS server fails.
- **None**—Switch user login database is never checked. Only a RADIUS server can be used for authentication.

If the switch database is selected as primary, there is no secondary option. The RADIUS server cannot be configured as a backup for the switch user login database.

When the primary AAA service is RADIUS, you have three secondary service choices:

- None
- Switch Database when RADIUS authorization fails
- Switch Database when RADIUS times out

When RADIUS login fails, even though RADIUS server is available, the additional service allows you the option to use the Switch Database as backup authentication service when the RADIUS server is not available. Alternatively, you can have no secondary AAA service, which means that only the primary service is used for authentication.

Use the **AAA Service** tab of the **Switch Administration** window to manage RADIUS.

Enabling and disabling RADIUS

At least one RADIUS server must be configured before you can enable RADIUS.

To enable or disable RADIUS, perform the following steps.

1. Open the **Switch Administration** window as described in [“Opening the Switch Administration window”](#) on page 31.
2. Select the **AAA Service** tab.
3. To enable RADIUS, select **RADIUS** from the **Primary AAA Service** drop-down menu.
4. Select **None**, **Switch Database when RADIUS Login Failed**, or **Switch Database when RADIUS Login Timeout** from the **Secondary AAA Service** menu.

NOTE

To disable RADIUS, select **Switch Database** from the **Primary AAA Service** menu and select **None** from the **Secondary AAA Service** menu.

5. Click **Apply**.

Configuring RADIUS

The configuration is chassis-based, so it applies to all logical switches (domains) on the switch and it is replicated on a standby CP, if one is present. It is saved in a configuration upload, and can be applied to other switches in a configuration download. You should configure at least two RADIUS servers so that if one fails, the other server assumes the service.

You can configure RADIUS even if it is disabled. You can configure up to five RADIUS servers. You must be logged in as admin, switchadmin, or securityadmin to configure RADIUS.

To configure RADIUS, perform the following steps..

1. Open the **Switch Administration** window as described in [“Opening the Switch Administration window”](#) on page 31.
2. Select the **AAA Service** tab.
3. Click **Add**.
The **RADIUS/ADLDAP/TACACS+ Configuration** dialog box displays. You can configure up to five RADIUS servers. If five RADIUS servers are already configured, the **Add** button is disabled.
4. Select **RADIUS** from **Server Type**.
5. Enter the RADIUS server name, as a valid IP address (in either IPv4 or IPv6 format) or Dynamic Name Server (DNS) string.
Each RADIUS server must have a unique IP address or DNS name for the RADIUS server.
6. Enter the port number.
7. Enter the secret string.
8. Enter the timeout time in minutes.
9. Select either **CHAP** or **PAP** as the authentication protocol.
The default value is CHAP, and if you do not change it, CHAP becomes the authentication protocol.
10. Click **OK** to return to the **AAA Service** tab.
11. Click **Apply**.

Modifying the RADIUS server

To change the parameters of a RADIUS server that is already configured, perform the following steps.

1. Open the **Switch Administration** window as described in [“Opening the Switch Administration window”](#) on page 31.
2. Select the **AAA Service** tab.
3. Select a RADIUS server from the **RADIUS Configuration** list.
4. Click **Modify**.
The **RADIUS/ADLDAP/TACACS+ Configuration** dialog box displays.
5. Enter new values for the port number, timeout time (in minutes), and secret string.
6. Select either **CHAP** or **PAP** as the authentication protocol.
The default value is CHAP, and if you do not change it, CHAP becomes the authentication protocol.
7. Click **OK** to return to the **AAA Service** tab.
8. Click **Apply**.

Modifying the RADIUS server order

The RADIUS servers are contacted in the order they are listed, starting from the top of the list and moving to the bottom.

To modify the RADIUS server order, perform the following steps.

1. Open the **Switch Administration** window as described in [“Opening the Switch Administration window”](#) on page 31.
2. Select the **AAA Service** tab.
3. Select a RADIUS server from the RADIUS Configuration list.
4. Click the up and down arrows to rearrange the order of the RADIUS servers.
5. Click **Apply**.

Removing a RADIUS server

To remove a RADIUS server, perform the following steps.

1. Open the **Switch Administration** window as described in [“Opening the Switch Administration window”](#) on page 31.
2. Select the **AAA Service** tab.
3. Select a RADIUS server from the **RADIUS Configuration** list.
4. Click **Remove**.

If there is no RADIUS server configured, the **Remove** button is disabled. You cannot remove the only RADIUS server if RADIUS is the primary AAA service.

The RADIUS server is not deleted until you apply the changes from the **AAA Services** tab.

5. Click **Apply** in the **AAA Services** tab.
A confirmation displays, warning you that you are about to remove the selected RADIUS server.
6. Click **Yes** in the confirmation.

Active Directory service management

Active Directory is the directory server that holds all the user profiles. Active Directory provides user authentication and authorization using LDAP as authentication protocol. Active Directory provides better security while using remote authentication mechanism.

You can add, remove, and modify settings of Active Directory Server.

Enabling Active Directory service

For adding a new Active Directory server, you must provide the server IP address, port number, secret string, timeout value, and LDAP as the authentication protocol. The server IP address may be in either IPv4 or IPv6 format. Select **Active Directory** as the server type; the dialog box displays LDAP as the only authentication protocol.

To enable Active Directory service, perform the following steps.

1. Open the **Switch Administration** window as described in [“Opening the Switch Administration window”](#) on page 31.
2. Select the **AAA Service** tab.
3. To enable Active Directory service, select **Active Directory** from the **Primary AAA Service** menu.
4. Select **None**, **Switch Database when Active Directory authentication failed**, or **Switch Database when Active Directory timeout** from the **Secondary AAA Service** menu.

NOTE

To disable **Active Directory** service, select **Switch Database** from the **Primary AAA Service** drop-down menu and select **None** from the **Secondary AAA Service** drop-down menu.

5. Click **Apply**.

Modifying Active Directory service

To change the parameters of a Active Directory service that is already configured, perform the following steps.

1. Open the **Switch Administration** window as described in [“Opening the Switch Administration window”](#) on page 31.
2. Select the **AAA Service** tab.
3. Select a server from the **ADLDAP Configuration** list.
4. Click **Modify**.
The **RADIUS/ADLDAP/TACACS+ Configuration** dialog box displays.
5. Enter new values for the port, timeout, and domain.
6. Click **OK** to return to the **AAA Service** tab.
7. Click **Apply**.

Removing Active Directory service

To remove an Active Directory server, perform the following steps.

1. Open the **Switch Administration** window as described in [“Opening the Switch Administration window”](#) on page 31.
2. Select the **AAA Service** tab.
3. Select a server from the **ADLDAP Configuration** list.
4. Click **Remove**.

NOTE

The server is not deleted until you apply the changes from the **AAA Services** tab.

5. Click **Apply** in the **AAA Services** tab.
A confirmation dialog box displays, warning you that you are about to remove the selected server.
6. Click **Yes** in the confirmation dialog box.

TACACS+ management

TACACS+ provides user authentication and authorization using TACACS as authentication protocol. You can add, remove, and modify settings of TACACS+ Server.

Enabling and disabling TACACS+

At least one TACACS+ server must be configured before you can enable TACACS+.

To enable or disable TACACS+, perform the following steps.

1. Open the **Switch Administration** window as described in [“Opening the Switch Administration window”](#) on page 31.
2. Select the **AAA Service** tab.
3. To enable TACACS+, select **TACACS+** from the **Primary AAA Service** drop-down menu.
4. Select **None**, **Switch Database when TACACS+ Login Failed**, or **Switch Database when TACACS+ Login Timeout** from the **Secondary AAA Service** menu.

NOTE

To disable TACACS+, select **Switch Database** from the **Primary AAA Service** menu and select **None** from the **Secondary AAA Service** menu.

5. Click **Apply**.

Configuring TACACS+

To enable TACACS+, perform the following steps.

1. Open the **Switch Administration** window as described in [“Opening the Switch Administration window”](#) on page 31.
2. Select the **AAA Service** tab.
3. Click **Add** to configure TACACS+ service.
4. Select **TACACS+** from **Server Type**.
5. Enter the **Server**, **Port**, **Timeout(s)**, **Secret String** details in the appropriate fields.
6. Select **CHAP** or **PAP** from the **Authentication** drop-down list.
7. Click **OK**.

The server details display in the **TACACS+ Configuration** list.

8. Click **Apply**.

Modifying TACACS+

To change the parameters of a TACACS+ service that is already configured, perform the following steps.

1. Open the **Switch Administration** window as described in [“Opening the Switch Administration window”](#) on page 31.
2. Select the **AAA Service** tab.
3. Select a server from the **TACACS+ Configuration** list.
4. Click **Modify**.
The **RADIUS/ADLDAP/TACACS+ Configuration** dialog box displays.
5. Enter new values for the fields you want to modify.
6. Click **OK** to return to the **AAA Service** tab.
7. Click **Apply**.

Removing TACACS+

To remove a TACACS+ server, perform the following steps.

1. Open the **Switch Administration** window as described in [“Opening the Switch Administration window”](#) on page 31.
2. Select the **AAA Service** tab.
3. Select a server from the **TACACS+ Configuration** list.
4. Click **Remove**.

NOTE

The server is not deleted until you apply the changes from the **AAA Services** tab.

5. Click **Apply** in the **AAA Service** tab.
A confirmation dialog box displays, warning you that you are about to remove the selected server.
6. Click **Yes** in the confirmation dialog box.

IPsec concepts

Internet Security Protocol (IPsec) is a set of open standards that provide cryptographic security services for IP networks. Several protocols are available for providing authentication and secure transmission of data.

From Web Tools, you can establish IPsec policies for FCIP implementations on 7800 extension switches with the upgrade license, the 7500 extension switches and FR4-18i blades, and you can establish IPsec policies for IP interfaces that provide management access to switches and control processors.

There are several protocols and algorithms that can be applied. Choosing the protocols and algorithms you want to use may be a matter of adapting to an implementation that is already in place in your LAN, or you may need to do a significant amount of research and planning. The supported protocols and algorithms are defined and described in the RFCs listed in [Table 17](#).

TABLE 17 Relevant RFCs

RFC number	Title
RFC 4301	Security Architecture for the Internet Protocol
RFC 4302	IP Authentication Header
RFC 4303	IP Encapsulating Security Payload
RFC 4304	Extended Sequence Number (ESN) Addendum to IPsec Domain of Interpretation (DOI) for Internet Security Association and Key Management Protocol (ISAKMP)
RFC 4305	Cryptographic Algorithm Implementation Requirements for Encapsulating Security Payload (ESP) and Authentication Header
RFC 4869	Suite B Cryptographic Suites for IPsec
RFC 4309	Using Advanced Encryption Standard (AES) CCM Mode with IPsec Encapsulating Security Payload (ESP)
RFC 4306	Internet Key Exchange Version 2 (IKEv2) Protocol
RFC 4307	Cryptographic Algorithms for Internet Key Exchange Version 2 (IKEv2)
RFC 3971	Secure Neighbor Discovery
RFC 3972	Cryptographically Generated Addresses
RFC 3041	Privacy Extensions for Stateless Address Auto configuration in IPv6

Transport mode and tunnel mode

Transport mode adds an authentication header (AH) before the IP header. Only a single pair of addresses is used (those in the IP header). When transport mode is used, both endpoints implement IPsec.

Tunnel mode encapsulates an IP datagram in a new datagram, with a new IP header specifying the addresses of the tunnel end points. IPsec is implemented between tunnel endpoints. IPsec is transparent to the actual endpoints within the IP header in the original packet.

[Figure 41](#) provides a basic visual comparison of how transport mode and tunnel mode modify an IP datagram.

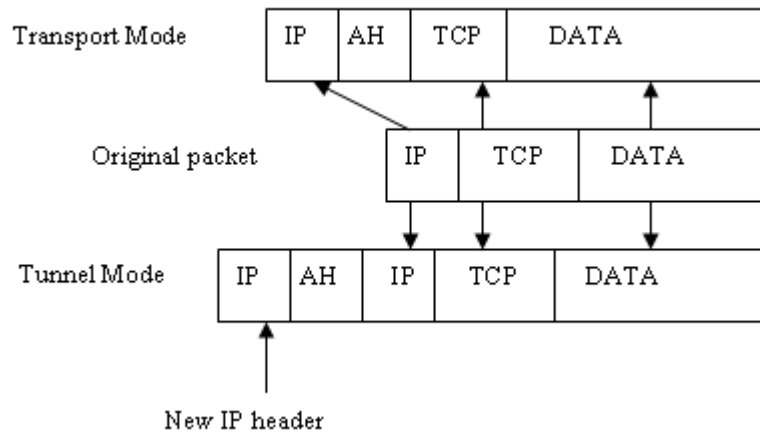

FIGURE 41 Transport mode and tunnel mode comparison

IPsec header options

IPsec adds headers to an IP datagram to enable authentication and privacy. There are two options:

- Authentication Header (AH)
- Encapsulating Security Payload (ESP)

Authentication Header

AH can be used to authenticate a data stream, but does not provide encryption needed for privacy. The AH contains a message authentication code (MAC). The MAC is created by a hash algorithm calculation. The MAC is transmitted in an IP datagram. The same hash algorithm is then used by the receiver to verify the integrity of the packet. AH can be used in either transport mode or tunnel mode, as shown in [Figure 42](#).

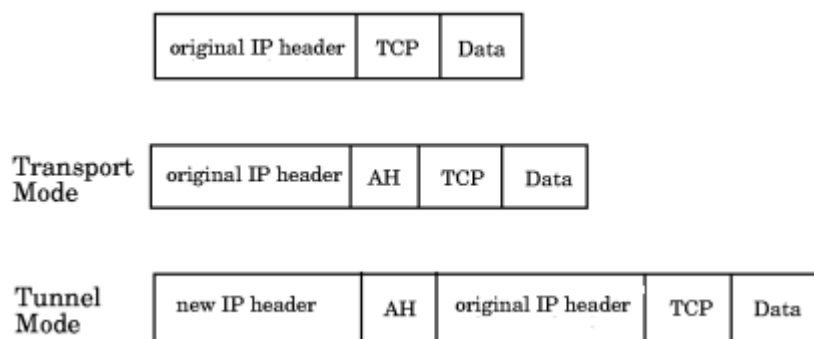

FIGURE 42 AH header in transport mode and tunnel mode

Encapsulating Security Payload

ESP provides authentication, and also provides privacy by encrypting the IP datagram. The use of an ESP header is similar to the use of the AH header. A hash algorithm is used to calculate an authentication value, the authentication value is sent in an IP datagram, and the same hash algorithm is used by the receiver to verify the authentication value. ESP can be used in either transport mode or tunnel mode, as shown in [Figure 43](#).

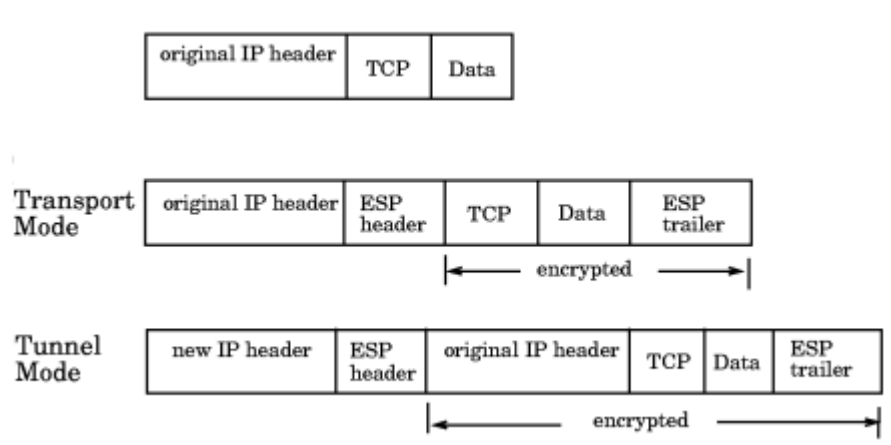

FIGURE 43 ESP header in transport mode and tunnel mode

Basic IPsec configurations

There are three basic configurations for IPsec use:

- Endpoint to Endpoint
- Gateway to Gateway
- Endpoint to Gateway

Endpoint to Endpoint

In an endpoint to endpoint configuration, both endpoints implement IPsec. Transport mode is commonly used in endpoint to endpoint configurations, and only a single pair of addresses is used. Typically, this kind of configuration would be used for direct communication between hosts. There are two drawbacks to consider:

- If network address translation (NAT) is used on the connection, one or both endpoints may be behind a NAT node. If that is the case, UDP must be used to encapsulate the tunneled packets. Port numbers in the UDP headers can then be used to identify the endpoint behind the NAT node.
- Packets cannot be inspected or modified in transit. This means that QoS, traffic shaping, and firewall applications cannot access the packets, and does not work.

Gateway to Gateway

In a gateway to gateway configuration, IPsec protection is implemented between network nodes. Tunnel mode is commonly used in a gateway to gateway configuration. A tunnel endpoint represents a set of IP addresses associated with actual endpoints that use the tunnel. IPsec is transparent to the actual endpoints.

Endpoint to Gateway

In an endpoint to gateway configuration, a protected endpoint connects through an IPsec protected tunnel. This can be used as a virtual private network (VPN) for connecting a roaming computer, like a service laptop, to a protected network.

Internet Key Exchange concepts

Internet Key Exchange (IKE) is used to authenticate the end points of an IP connection, and to determine security policies for IP traffic over the connection. The initiating node proposes a policy based on the following:

- An encryption algorithm to protect data.
- A hash algorithm to check the integrity of the authentication data.
- A Pseudo-Random Function (PRF) algorithm that can be used with the hash algorithm for additional cryptographic strength.
- An authentication method requiring a digital signature, and optionally a certificate exchange.
- A Diffie-Hellman exchange that generates prime numbers used in establishing a shared secret key.

Encryption algorithms

An encryption algorithm is used to encrypt messages used in the IKE negotiation. [Table 18](#) lists the available encryption algorithms. A brief description is provided. If you need further information, please refer to the RFC.

TABLE 18 Encryption algorithm options

Encryption algorithm	Description	RFC number
3des_cbc	3DES processes each block three times, using a unique 56-bit key each time.	RFC 2451
null_enc	No encryption is performed.	
aes128_cbc	Advanced Encryption Standard (AES) 128 bit block cipher.	RFC 4869
aes256_cbc	Advanced Encryption Standard (AES) 256 bit block cipher.	RFC 4869

Hash algorithms

Hash message authentication codes (HMAC) check data integrity through a mathematical calculation on a message using a hash algorithm combined with a shared, secret key. Table 19 lists the available encryption algorithms. The sending computer uses the hash function and shared key to compute a checksum or code for the message, and sends it to the receiving computer. The receiving computer must perform the same hash function on the received message and shared key and compare the result. If the hash values are different, it indicates that a third party may have tampered with the message in transit, and the packet is rejected.

TABLE 19 Hash algorithm options

Hash algorithm	Description	RFC/Publication number
aes_xcbc	Uses a cypher block and extended cypher block chaining (CBC).	RFC 3566
hmac_md5	The MD5 computation produces a 128-bit hash.	RFC 1321
hmac_sha1	The SHA1 computation produces a 160-bit hash.	FIPS Pub 180-1

Pseudo-Random Function algorithm

The Pseudo-Random Function (PRF) algorithm generates output that appears to be random data, using the HMAC chosen as the hash algorithm as the seed value. PRF is used to strengthen security.

Public key certificate-based authentication

Industry standard X.500 database servers are available as certificate authority servers to enable certificate-based authentication of computers.

SA lifetime

The SA lifetime may be defined as the number of bytes transmitted before the SA is rekeyed, or as a time value in seconds, or both. When both are used, the SA lifetime is determined by the threshold that is first reached. Whenever an SA lifetime expires, the security association (SA) is renegotiated and the key is refreshed or regenerated.

For example, if a 200 MB file is transferred with a 100 MB lifetime, at least two keys are generated. If a communication takes one hour, and you specify a lifetime of 300 seconds (five minutes), more than 12 keys may be generated to complete the communication.

The SA lifetime limits the length of time a key is used before it is replaced by a new key, thus limiting the amount of time a given key is available to a potential attacker. Part of a message may be protected by an old key, while new keys protect the remainder of the message, so even if an attacker deciphers one key, only a portion of the message is vulnerable.

Diffie-Hellman groups

Diffie-Hellman (DH) groups are used to determine the length of the base prime numbers for the Diffie-Hellman exchange. Diffie-Hellman key exchange is a cryptographic protocol that allows two parties that have no prior knowledge of each other to jointly establish a shared secret key over an insecure communications channel.

DH group choices are 1(modp768), 2(modp1024), 14(modp2048), and 18(modp8192). Each group provides an incrementally more secure key exchange by providing more bits (768, 1024, 2048, 8192).

Authentication methods

The methods used to authenticate the IKE peer are preshared key (psk), DSS digital signature (dss), and RSA digital signature (rsasig):

- A Preshared key (PSK) is a shared secret that is shared between two parties over a secure channel before it is used. Typically, the PSK is a password or pass phrase. PSKs are created in the end systems used by the two parties. There are several tools available to help select a strong key that will work with various operating systems. When choosing a tool and creating a PSK, keep in mind that the cryptographic strength of a key generally increases with length.
- The Digital Signature Standard (DSS) makes use of a private key to generate a digital signature. Each user possesses a private and public key pair. Signature generation can be performed only by the possessor of the user's private key. The digital signature is sent to the intended verifier in a message. The verifier of the message and signature verifies the signature by using the sender's public key.
- The RSA digital signature process uses a private key to encrypt only the message digest. The encrypted message digest becomes the digital signature and is attached to the original data. To verify the contents of digitally signed data, the recipient generates a new message digest from the data that was received, decrypts the original message digest with the originator's public key, and compares the decrypted digest with the newly generated digest. If the two digests match, the integrity of the message is verified. The identity of the originator also is confirmed because the public key can decrypt only data that has been encrypted with the corresponding private key.

IPsec over management ports

IPsec can be applied to the management port on a switch or a CP blade to establish a secure connection between a PC or workstation and Web Tools. The connection can be used as a virtual private network (VPN) interface to Web Tools.

At a high level, the steps to take are:

- Access the Ethernet IPsec Policies dialog box.
- Enable IPsec.
- Create an IKE policy for authentication.
- Create an security association (SA).
- Create an SA proposal.
- Add a IPsec Transform policy, referencing the IKE policy and the SA proposal.
- Add an IPsec selector that allows you to apply a Transform policy to a specific IP flow.

Enabling the Ethernet IPsec policies

To access the **Ethernet IPsec Policies** dialog box, perform the following steps.

1. Open the **Switch Administration** window.
2. Select **Show Advanced Mode**.
3. Select the **Security Policies** tab.
4. Under **Security Policies**, select **Ethernet IPsec**.
The **Ethernet IPsec Policies** screen displays.
5. Ethernet IPsec policies can be configured only after enabling IPsec by clicking the **Enable** button below the **Ethernet IPsec policies** table.

Establishing an IKE policy

When you establish an IKE policy, you identify a set of algorithms and authentication rules and parameters to use in a key exchange. Refer to the *Fabric OS Administrator's Guide* for details on IKE functionality.

To establish an IKE policy, perform the following steps.

1. Select the **IKE** tab on the **IPsec Policies** window for Ethernet IPsec.
The **Add IKE Policy** dialog box displays.
2. Enter an **IKE Policy Name**.
3. Enter the IP address of the authentication partner in the **Peer IP Address** field.
4. Enter the switch's local identifier in the **Local Identifier** field.
This is normally the IP address in IPv4 or IPv6 format, but it may also be a DNS name.
5. Enter the identifier of the remote peer switch in **Peer Identifier**.
This is normally the IP address in IPv4 or IPv6 format, but it may also be a DNS name.
6. Select the **Encryption Algorithm** option.
7. Select the **Hash Algorithm** option.
8. Select the **PRF Algorithm** option.
9. Select the **DH Group Number** option.
10. Select the **Authentication Method** option.
11. If PSK is chosen as the authentication method, enter the name of the file that holds the pre-shared key in the **Pre-Shared Key filename** field.
12. If you are using an X.509 certificate for authentication, enter the appropriate file names in the **Public Key filename**, **Private Key filename**, and **Peer Public Key filename** fields in PEM format.
13. Use the **PFS** selector to turn Perfect Forward Secrecy (PFS) on or off.
PFS provides additional security by means of a Diffie-Hellman shared secret value. With PFS, if one key is compromised, previous and subsequent keys are secure because they are not derived from previous keys.

Creating a security association

A security association (SA) describes a set of parameters for providing secure communications between two endpoints.

To create a security association, perform the following steps.

1. Select the **IPsec** tab.

The **IPsec Policies** screen displays.

2. Select the **SA** tab.

3. Select **Add**.

The **Add SA** dialog box displays.

4. Enter a name for the SA in the **SA Name** field.

5. Select the **IPsec Protocol** option.

The choices are ah (for authentication header) and esp (for encapsulated security protocol).

6. Select the **Authentication Algorithm** option.

7. Select the **Encryption Algorithm** option.

8. Optionally, enter a value in the **SPI number** field.

A Security Parameter Index (SPI) number is automatically assigned, but may be manually overridden.

9. Click **OK**.

Creating an SA proposal

An SA proposal is sent from one endpoint to another to negotiate IKE and IPsec policies. An SA proposal contains one or more security associations (SA). The endpoints must find a match for each of the following in the SAs sent in the SA proposal:

- The IKE authentication method.
- The IKE encryption algorithm.
- The IKE hash algorithm.
- The Diffie-Hellman group number.
- The IKE SA lifetime.
- The IP addresses of the endpoints.
- The IPsec protocol (AH or ESP).
- The IPsec Transform policy.

To create an SA proposal, perform the following steps.

1. Select the **SA Proposal** tab on the **IPsec Policies** screen.

2. Select **Add**.

The **Add-SA Proposal** dialog box displays.

3. Enter a name in the **SA Proposal Name** field.

4. Enter the SAs in the **SA(s) to use** field.

5. Optionally, define SA lifetime parameters.

The SA lifetime may be defined as a time value in seconds (**LifeTime in seconds**), as the number of bytes transmitted before the SA is rekeyed (**LifeTime in bytes**), or both. When both are used, the SA lifetime is determined by the threshold that is first reached.

6. Click **OK**.

Adding an IPsec transform policy

The IPsec transform policy is the combination of protocols and algorithms applied to a flow of IP packets. IPsec unidirectional, and policies need to be applied to both inbound and outbound flows.

Part of adding an IPsec transform policy is to select an IPsec Protection Type. The choices are discard, bypass, and protect:

- Discard causes data packets to be rejected if there is an invalid pair of source and destination addresses or invalid port addresses.
- Bypass allows a data packet to be transmitted or received without IPsec protection.
- Process indicates a data packet is processed using IPsec encryption, IKE authentication, or both, using encapsulation security protocol (ESP) processing, or authentication header (AH) protocol processing.

To add an IPsec transform policy, perform the following steps.

1. Select the **Transforms** tab.
The **Transforms** screen displays.
2. Select **Add**.
The **Add Transform** dialog box displays.
3. Enter a name in the **Transform Name** field.
4. Select the **IPsec Mode**.
The choices are **Transport** or **Tunnel**.
5. Enter the **SA Proposal** name.
6. Select the **IPsec Protection Type** option.
7. Select the **IKE Policy Name** option.

IKE policies need to be created before adding a transform policy. If there are no names to select from, you must create an IKE policy.

8. *Optional:* Enter a local and peer IP address.
9. Click **OK**.

Adding an IPsec selector

Selectors are used to apply transform policies to an IP flow. Flows are uni-directional. Selectors are associated with a specific source IP address, a specific peer IP address, and a specific transform.

1. Select the **Selectors** tab.
The **Selectors** screen displays.
2. Select **Add**.

The **Add Selector** dialog box displays.

3. Enter a name in the **Selector Name** field.
4. Select the **Traffic Flow Direction** (in or out).
IPsec policies are unidirectional, and must be applied separately to inbound and outbound flows.
5. Enter the IP address of the sender in the **Source IP Address** field.
6. Enter the IP address of the receiver in the **Peer IP Address** field.
7. Enter the **Transform Name** value.
8. The **Protocol Name** selector allows you to select a specific protocol.
9. Click **OK**.

Manually creating an SA

Part of manually creating an security association (SA) is to select an IPsec Protection Type. The choices are discard, bypass, and protect:

- Discard causes data packets to be rejected if there is an invalid pair of source and destination addresses or invalid port addresses.
- Bypass allows a data packet to be transmitted or received without IPsec protection.
- Process indicates a data packet is processed using IPsec encryption, IKE authentication, or both, using encapsulation security protocol (ESP) processing, or authentication header (AH) protocol processing.

To manually create a SA, perform the following steps.

1. Select the **SA(Manual)** tab.
2. Select **Add**.

The **Add Manual-SA** dialog box displays.

3. Enter a security parameter index number in the **SPI (Hexadecimal)** field.
The SPI must be manually applied when manually adding an SA.
4. Enter the IP address of the endpoint that sends the SA in the **Source IP Address** field.
5. Enter the IP address of the endpoint that receives the SA in the **Peer IP Address** field.
6. Select the protocol used to carry the transmission using the **Protocol Name** selector.
7. Select the **Traffic Flow Direction** (in or out).

IPsec policies are unidirectional, and must be applied separately to inbound and outbound flows.

- For the flow from peer to source, select **in**.
- For the flow from source to peer select **out**.

8. Select the **IPsec Mode**.

The choices are **Transport** or **Tunnel**. Refer to [“Transport mode and tunnel mode”](#) on page 189 if you are unfamiliar with Transport and Tunnel modes.

9. Select the **IPsec Protocol**.

The choices are **ah** (for authentication header) and **esp** (for encapsulated security protocol).

10. Select the **IPsec Protection Type** option.
11. Select the **Authentication Algorithm** option.
12. Enter or copy a generated encryption key in the **Encryption Key** field.
13. Select the **Encryption Algorithm**.
14. Enter or copy a generated authentication key in the **Authentication Key** field.
15. *Optional:* Enter a local and peer tunnel IP address.
16. Click **OK**.

Editing an IKE or IPsec policy

An existing IKE or IPsec policy can be edited.

To edit an IKE or IPsec policy, perform the following steps.

1. Open the **Switch Administration** window.
2. Click **Show Advanced Mode**.
3. Select the **Security Policies** tab.
4. Under **Security Policies**, select **Ethernet IPsec** or **Ethernet IPsec**.
5. Select the policy you want to edit.
6. Select **Edit**.

An **Edit Policy** dialog box displays.

7. Edit the policy as needed.
8. Click **OK**.

Deleting an IKE or IPsec policy

You can delete one or more IKE or IPsec policies.

To delete an IKE or IPsec policy, perform the following steps.

1. Open the **Switch Administration** window.
2. Select **Show Advanced Mode**.
3. Select the **Security Policies** tab.
4. Under **Security Policies**, select **Ethernet IPsec** or **Ethernet IPsec**.
5. Select the policy or policies you want to delete.
6. Select **Delete**.

The policy is deleted from the SA database (SADB), and is removed from the list.

Establishing authentication policies for HBAs

To establish and enable authentication policies for HBAs as the log in to a fabric, perform the following steps.

1. Open the **Switch Administration** window.
2. Click **Show Advanced Mode**.
3. Select the **Security Policies** tab.
4. Select **Authentication** under Security Policies.
The **Authentication Policy Settings** screen displays.
5. Under **Configure Authentication Policy**, do the following.
 - Select the **Authentication Type**. The choices are FCAP, DHCHAP, or both.
 - Select the **Switch Authentication Policy Mode**. The choices are Passive, Active, On, or Off.
 - Select the **Hash Type** used. The choices are SHA1, MD5, or both.
 - Select the **DH-Group Type**. The choices are 0, 1, 2, 3, 4; 0 (DH Null option), 1 (1024 bit key), 2 (1280 bit key), 3 (1536 bit key), or 4 (2048 bit key).
 - Use the **Device Authentication Policy Mode** selector to set the desired mode. The choices are On, Off, or Passive.
 - Click **Apply**.
6. If your authentication method uses a shared secret, select the **Shared Secret Keys** tab.
The **Shared Secret Keys** screen displays.
7. Select **Add**.
The **Add Shared Secret Keys** dialog box displays.
8. Enter or browse to select the switch/HBA WWN or name or domain ID in the **Switch or HBA WWN/Name/Domain ID** field.
9. Enter the shared secret key for the peer device (an HBA in this case) in the **Peer Shared Secret** and **Confirm Peer Shared Secret** fields.
10. Enter the shared secret for switch in the **Local Shared Secret** and **Confirm Local Shared Secret** fields.
11. Click **Add**.
An entry is added in the **Switch WWN** box.
12. Click **OK**.
13. Add more shared secrets, if needed.

Administering FICON CUP Fabrics

In this chapter

- [FICON CUP fabrics overview](#) 201
- [Enabling port-based routing](#) 202
- [Enabling or disabling FICON Management Server mode](#) 203
- [FMS parameter configuration](#) 203
- [Displaying code page information](#) 205
- [Viewing the control device state](#) 205
- [Allow / Prohibit Matrix configuration](#) 206
- [CUP logical path configuration](#) 210
- [Link Incident Registered Recipient configuration](#) 211
- [Displaying Request Node Identification Data](#) 212

FICON CUP fabrics overview

Control Unit Port (CUP) is a protocol for managing FICON directors. Host-based management programs manage the switches using CUP protocol by sending commands to the emulated control device implemented by Fabric OS. A Brocade switch or director that supports CUP can be controlled by one or more host-based management programs or director consoles, such as Brocade Web Tools or Brocade Network Advisor. (Refer to the *Brocade Network Advisor SAN User Manual* for more information about the Brocade Network Advisor.) The director allows control to be shared between host-based management programs and director consoles.

NOTE

To perform FICON CUP operations, the EGM license must be enabled on the switches using the CUP protocol. Also, the EGM license must be enabled to set the Allow/Prohibit Matrix parameters.

NOTE

While enabling FMS mode with online devices connected to ports with addresses of 0xFE or 0xFF, the following error displays.

FMS mode enable failed due to port(s) with areas 0xFE or 0xFF is(are) connected to device(s).

User must disable the ports, or remove the online devices from those ports that are mapped to the 0xFE or 0xFF address.

To use FICON CUP, you must do the following:

- Install a FICON CUP license on a FICON director.
- Enable FICON Management Server (FMS) mode on the FICON director.

- Install a FICON CUP license on the Brocade switch.
- Configure CUP attributes (FMS parameters) for the FICON director.

FMS mode enable failed due to ports with areas 0xFE or 0xFF are connected to devices.

You can use Web Tools for all of these tasks. You can also use Web Tools to manage FICON directors (when FMS mode is enabled on those directors) to do the following:

- Display the control device state
- Display a code page
- Manage port connectivity configuration

You do not need to install the FICON CUP license to perform FICON CUP management; you *must* install the FICON CUP license, however, if your switch is to enforce traffic between the FICON director and the host-based management program.

NOTE

If the switch does not have the FICON_CUP license installed, Web Tools prevents the enabling of FMS mode, and displays the following error message:

Enabling FMS mode requires FICON CUP license installed on the switch. Contact your preferred storage vendor for more details.

Enabling port-based routing

Port-based path selection is a routing policy in which paths are chosen based on ingress port and destination only. This also includes user-configured paths. All ports with FICON devices attached must have port-based routing policy enabled. Port-based routing is a per-switch routing policy. After port-based routing is enabled, you can continue with the remaining FICON implementation.

To enable port-based routing, perform the following steps.

1. Select a switch with FICON devices attached from the **Fabric Tree**.
2. Open the **Switch Administration** window as described in [“Opening the Switch Administration window”](#) on page 31.
3. Click the **FICON CUP** tab.

If the EGM license is not installed on the switches using CUP protocol, access to this feature is denied and an error message displays. If the EGM license is enabled, the **FICON CUP** tab is available.
4. Click **Enable** in the **FICON Management Server Mode** section to enable the port-based routing policy, or click **Disable** to disable port-based routing.

NOTE

While enabling FMS mode with online devices connected to FE ,FF the below error will be shown.

FMS mode enable failed due to port(s) with areas 0xFE or 0xFF is(are) connected to device(s).

5. Click **Apply** to save your changes.

Enabling or disabling FICON Management Server mode

FICON Management Server (FMS) is used to support switch management using CUP. To be able to use the CUP functionality, all switches in the fabric must have FICON Management Server mode (FMS mode) enabled. FMS mode is a per-switch setting. After FMS mode is enabled, you can activate a CUP license without restarting the director. You can use Web Tools to install a CUP license. For more information on installing licenses, refer to [“Activating a license on a switch”](#) on page 43.

When FMS mode is disabled, mainframe management applications, director consoles, or alternate managers cannot communicate with a director with CUP. In addition, when FMS mode is disabled on a director, you cannot configure CUP attributes.

To enable or disable FICON Management Server, perform the following steps.

1. Select a FICON CUP-capable switch from the **Fabric Tree**.
2. Open the **Switch Administration** window as described in [“Opening the Switch Administration window”](#) on page 31.
3. Click **Show Advanced Mode**.
4. Select the **FICON CUP** tab.

The FICON CUP tabbed page displays the **FICON Management Server** page. All attributes on this tab are disabled until FMS mode is enabled.

5. Click **Enable** in the **FICON Management Server Mode** section to enable FMS mode or click **Disable** to disable FMS mode.
6. Click **Apply** to save your changes.

FMS parameter configuration

FMS parameters control the behavior of the switch with respect to CUP itself, as well as the behavior of other management interfaces (director console, Alternate Managers). You can configure FMS parameters for a switch *only* after FMS mode is enabled on the switch. All FMS parameter settings are persistent across switch power cycles. There are six FMS parameters, as described in [Table 20](#).

TABLE 20 FMS mode parameter descriptions

Parameter	Description
Programmed Offline State Control	Controls whether host programming is allowed to set the switch offline. The parameter is set as enabled by the hardware after system installation, and can be reset by Web Tools.
Active=Saved Mode	<p>Controls the IPL file update. The IPL file saves port connectivity attributes and port names. After a switch restart or power cycle, the switch reads the IPL file and activates its contents as default configuration.</p> <p>When this mode is enabled, activating a configuration saves a copy to the IPL configuration file. All changes made to the active connectivity attributes or port names by host programming or alternate managers are saved in this IPL file. It keeps the current active configuration persistent across switch restarts and power cycles.</p> <p>You cannot directly modify the IPL file or save a file as an IPL file. When this mode is disabled, the IPL file is not altered for either new configuration activation or any changes made on the current active configuration. This parameter is set as enabled by the hardware after system installation, and can be reset by Web Tools.</p> <p>Note: When FMS mode is enabled and the Active=Saved parameter is disabled, you can enable and disable ports, but the setting is not persistent. When the Active=Saved parameter is enabled, you can enable and disable ports and the setting is persistent.</p>
Alternate Control Prohibited	<p>Determines whether alternate managers are allowed to modify port connectivity.</p> <p>Enabling this mode prohibits alternate manager control of port connectivity; otherwise, alternate managers can manage port connectivity.</p> <p>This parameter is set as enabled by the hardware after system installation, and can be reset by Web Tools.</p>
User Alert Mode	<p>Controls director console behavior for alerts.</p> <p>Enabling this mode prompts the director consoles to display a warning whenever you attempt an action that changes switch parameters. When you disable this mode, no warning is displayed. In this case, in which Web Tools is the director console, warning messages are displayed by Web Tools regardless of the setting of the parameter, since Web Tools always displays warning messages when you apply a change to a switch that changes parameters.</p> <p>This parameter is always read-only in Web Tools. Each time that the switch is powered on, the parameter is reset to disabled.</p>
Director Clock Alert Mode	<p>Controls behavior for attempts to set the switch timestamp clock through the director console. When it is enabled, the director console (Web Tools, in this case) displays warning indications when the switch timestamp is changed by a user application. When it is disabled, you can activate a function to automatically set the timestamp clock. There is no indication for timestamp clock setting.</p> <p>This parameter is set as disabled by the hardware after system installation, and can be reset by Web Tools.</p>
Host Control Prohibited	<p>Determines whether host programming allows modifying port connectivity.</p> <p>Enabling this mode prohibits host programming control of port connectivity; otherwise, host programming can manage port connectivity.</p> <p>This parameter is set as disabled by the hardware after system installation, and can be reset by Web Tools.</p>

Configuring FMS mode parameters

To configure FMS mode parameters, perform the following steps.

1. Select a FICON-enabled switch from the **Fabric Tree**.
2. Open the **Switch Administration** window as described in [“Opening the Switch Administration window”](#) on page 31.

3. Select the **FICON CUP** tab.

The **FICON CUP** page displays the **FICON Management Server** page. All attributes on this page are read-only until FMS mode is enabled.

4. To enable or disable an FMS mode parameter, click the check box next to the parameter.

A checked check box indicates that the parameter is enabled. You cannot configure the **User Alert Mode** parameter in Web Tools, as it is read-only.

Displaying code page information

The **Code Page** section identifies the language used to exchange information between the FICON director and Host Programming. It is a read-only field in Web Tools, as it is set by Host Programming only. When FMS mode is disabled, the code page is displayed as unavailable.

To display code page information, perform the following steps.

1. Select a FICON-enabled switch from the **Fabric Tree**.
2. Open the **Switch Administration** window as described in [“Opening the Switch Administration window”](#) on page 31.
3. Select the **FICON CUP** tab.

The **FICON CUP** page displays the **FICON Management Server** page in front. All attributes on this tab are read-only until FMS mode is enabled.

The code page format is displayed in the **Code Page** section as shown in the following example:

```
Language used to exchange information with Host Programming: (EBCDIC)
USA/Canada -- 00037
```

Viewing the control device state

The control device is in either a neutral or a switched state. When it is neutral, the control device accepts commands from any channel that has established a logic path with it and accepts commands from alternate managers. When the control device is switched, it establishes a logical path and accepts commands only from that logical path (“device allegiance”). Commands from other paths cause a FICON CUP Busy Error. Most “write” operations from alternate managers are also rejected.

Device allegiance usually lasts for a very short time. However, under abnormal conditions, device allegiance can get “stuck” and fail to terminate. It might cause the switch to be unmanageable with CUP, and you will continue to receive the FICON CUP Busy Error. In this case, you should check the control device state and the last update time to identify if the device allegiance is stuck. The Web Tools **Switch Administration** window displays the control device state and last update time. You can click **Refresh** to get most recent update.

NOTE

You can manually reset allegiance to bring the control device back to the neutral state by clicking **Reset Allegiance** in the **FICON CUP Busy Error** dialog box.

The following switch parameters being read or modified can cause the FICON CUP Busy error:

- Mode Register
- Port Names (also called Port Address Name)
- Allow/Prohibit Matrix and Port Connectivity Attributes
- Switch enable/disable
- Switch name change

To access the FICON CUP tab, perform the following steps.

1. Select a FICON-enabled switch from the **Fabric Tree**.
2. Open the **Switch Administration** window as described in [“Opening the Switch Administration window”](#) on page 31.
3. Select the **FICON CUP** tab.

The FICON CUP tabbed page displays, with the FICON Management Server subtabbed page in front. All attributes on this tab are read-only until FMS Mode is enabled.

The control device state is displayed as neutral or switched in the Control Device Allegiance field.

NOTE

If FMS mode is enabled, and the control device state is unavailable, the FICON CUP Busy Error is displayed. Click **Reset Allegiance** in the error message to reset the control device state to its correct state.

Allow / Prohibit Matrix configuration

In the Allow / Prohibit Matrix subpanel, you can manage the configuration files and active configuration. All configuration files and the active configuration are listed in a table. The active configuration is listed as “Active Configuration*” and the description in the table is “Current active configuration on switch.” The other special configuration file is the IPL. Any other files displayed are user-defined configurations and are stored on the switch.

You can create, activate, copy, or delete saved Allow / Prohibit Matrix configurations; however, you can only edit or copy a configuration while it is active. You can also activate, edit, or copy the IPL configuration. You must have FMS mode enabled before you can make any changes to the configurations. Click **Refresh** to get the latest configuration file list from the switch.

When creating a new configuration or editing an existing configuration, the Web Tools port name is restricted to printable ASCII characters. Characters beyond printable ASCII characters are displayed as dots.

When initially installed, a switch allows any port to dynamically communicate with any other port. Two connectivity attributes are defined to restrict this any-to-any capability for external ports: *Block* and *Prohibit*.

Block is a port connectivity attribute that prevents all communication through a port. Prohibit is the port connectivity attribute that prohibits or allows dynamic communication between ports when a port is not blocked. Each port has a vector specifying its Prohibit attribute with respect to each of the other ports in the switch. This attribute is always set symmetrically in that a pair of ports is either prohibited or allowed to communicate dynamically.

The Port Connectivity table (shown in [Figure 45](#) on page 209) displays the Port number (in physical-location format), Port Name (port address name), Block attribute, Prohibit attribute, and Area Id (port address, displayed in hexadecimal) in fixed columns. The right side is a port matrix, that lists all ports by Area ID and identifies prohibited ports. Those columns are scrollable and swappable.

Viewing Allow / Prohibit Matrix configurations

To display a list of Allow / Prohibit Matrix configurations, perform the following steps.

1. Select a FICON-enabled switch from the **Fabric Tree**.
2. Select **Configure > Switch Admin**.
3. Click **Show Advanced Mode** to see all the available tabs and options.
4. Select the **FICON CUP** tab.

The **FICON CUP** page displays the **FICON Management Server** page in front. All attributes on this page are read-only until FMS mode is enabled.

5. Click the **Allow / Prohibit Matrix** subtab.

Modifying Allow / Prohibit Matrix configurations

In the **Allow / Prohibit Matrix Configuration** dialog box, swapped ports are indicated with the “(Swapped)” label ([Figure 44](#)).

Port Area ▲	OC
00	
01 (Swapped)	
02 (Swapped)	
03 (Swapped)	
04 (Swapped)	
05 (Swapped)	
06	
07 (Swapped)	
08 (Swapped)	
09 (Swapped)	
0A	

FIGURE 44 Edit Allow / Prohibit Matrix dialog box swapped label

To create a new Allow / Prohibit Matrix configuration or to edit an existing configuration, perform the following steps.

1. Display the Allow / Prohibit Matrix configuration list.
2. You can either create a new configuration or edit an existing configuration:
 - To create a new configuration, click **New**.

The **Allow / Prohibit Matrix Configuration** dialog box displays all ports and port names on the selected switch (similar to the dialog box shown in [Figure 45](#)). The **Block** column, **Prohibit** column, and prohibited ports matrix are displayed as empty, for you to configure.

- To edit an existing configuration, click the configuration, and then click **Edit**.

The **Allow / Prohibit Matrix Configuration** dialog box displays the content of the selected configuration from the switch in a table format ([Figure 45](#)).

3. *Optional:* Select the check box corresponding to a port you want to block on the **Block** column. Repeat this step for all ports you want to block. Select the **Block All** check box to block all ports.
4. *Optional:* Select the check box corresponding to a port you want to prohibit on the **Prohibit** column. Repeat this step for all ports you want to prohibit. Select the **Prohibit All** check box to prohibit all ports.

The cells in the matrix are updated with crossed-circle icons to identify prohibited ports.

FE and FF ports are not shown in the Allow / Prohibit Matrix dialog. The FE and FF Ports state displays only in the Port Admin page.

5. *Optional:* Click the individual cells corresponding to the combination of ports you want to prohibit. You cannot prohibit a port to itself.

If you prohibit E_Port, E-E connection, or E-F connection, a warning message is displayed, “You have placed a prohibit on an E-Port. This has no effect for Fabric OS based fabrics”.

6. Review your changes. A blue background in a cell indicates that its value has been modified.
7. After you have finished making changes, do any of the following:
 - Click **Activate** to save the changes and make the configuration active immediately, as described in [“Activating an Allow / Prohibit Matrix configuration”](#) on page 209.
 - Click **Save** to save the changes but not make the configuration active.
 - Click **Save As** to save the configuration to a new configuration file. When you click **Save As**, a dialog box displays in which you should enter a file name and description for the configuration file.
 - Click **Refresh** to refresh the information from the switch.
 - Click **Cancel** to cancel all changes without saving.

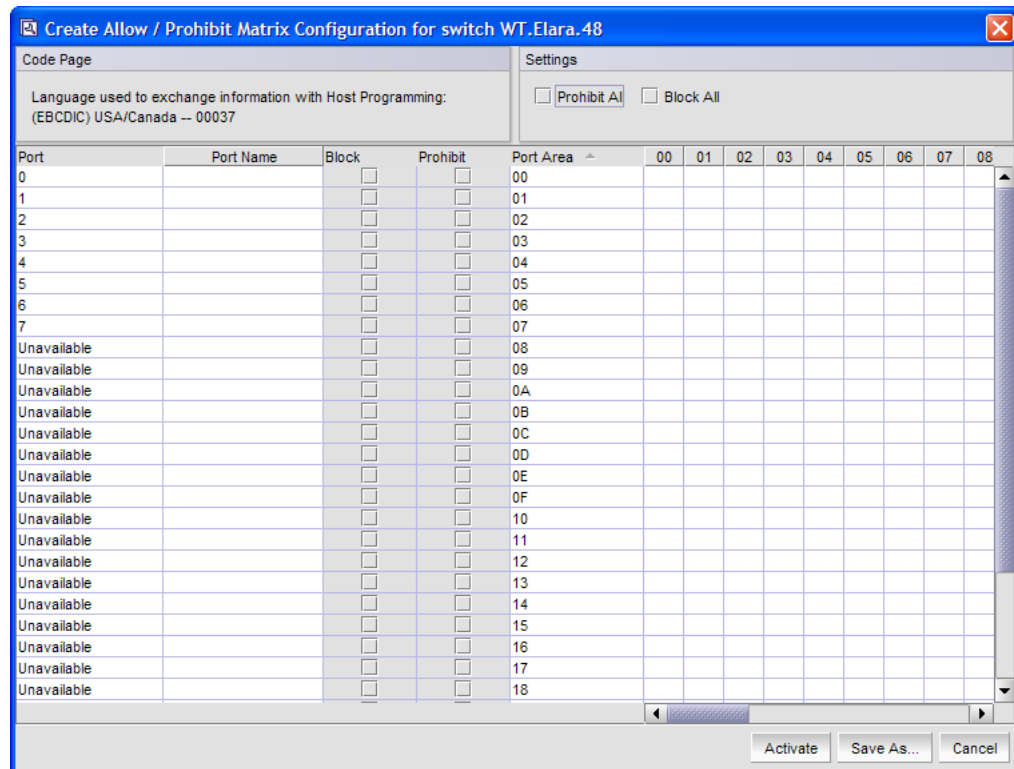

FIGURE 45 Allow / Prohibit Matrix Configuration dialog box

Activating an Allow / Prohibit Matrix configuration

When you activate a saved Allow / Prohibit Matrix configuration on the switch, the preceding configuration (currently activated) is overwritten.

To activate an Allow / Prohibit Matrix configuration, perform the following steps.

1. Open the Allow / Prohibit Matrix configuration list.
2. Select the saved configuration from the list.
3. Click **Activate**.

The **Activate Allow / Prohibit Matrix Configuration** confirmation dialog box displays. The message reminds you that the current configuration will be overwritten upon activation.

4. *Optional:* Click **Active=Saved Mode** to enable (selected) or disable (not selected) the **Active=Saved FMS** parameter after the configuration is activated.
5. Click **Yes** to activate the configuration or click **No** to cancel the activation.

Copying an Allow / Prohibit Matrix configuration

To copy an Allow / Prohibit Matrix configuration to a new configuration, perform the following steps.

1. Display the Allow / Prohibit Matrix configuration list.
2. Select a saved configuration or the active configuration from the list.

3. Click **Copy**.

The **Allow / Prohibit Matrix Configuration** dialog box displays.

4. In the dialog box, enter a name and description for the new configuration and click **OK** to save the configuration to the target file; click **Cancel** to cancel copying the configuration.

The file name must be in alphanumeric characters and can contain only dashes or underscores as special characters.

Deleting an Allow / Prohibit Matrix configuration

To delete a saved Allow / Prohibit Matrix configuration.

1. Display the Allow / Prohibit Matrix configuration list.
2. Select the saved configuration from the list.
3. Click **Delete**.

The **Delete Allow / Prohibit Matrix Configuration** confirmation dialog box displays.

4. Click **Yes** to delete the selected configuration; click **No** to cancel the deletion.

CUP logical path configuration

The logical reporting path is a CUP mechanism for sending FRU-failure type reports to a FICON Logical Path via the FICON Protocol.

Viewing CUP logical path configurations

To display a list of CUP logical path configurations, perform the following steps.

1. Select a FICON-enabled switch from the **Fabric Tree**.
2. Select **Configure > Switch Admin**.
3. Click **Show Advanced Mode** to see all the available tabs and options.
4. Select the **FICON CUP** tab.

The **FICON CUP** page displays the **FICON Management Server** page in front. All attributes on this page are read-only until FMS mode is enabled.

5. Click the **CUP Logical Paths** subtab.

Configuring CUP logical paths

To configure a CUP logical path, perform the following steps.

1. Select a FICON-enabled switch from the **Fabric Tree**.
2. Select **Configure > Switch Admin**.
3. Click **Show Advanced Mode** to see all the available tabs and options.
4. Select the **FICON CUP** tab.

The **FICON CUP** page displays the **FICON Management Server** page in front. All attributes on this page are read-only until FMS mode is enabled.

5. Click the **CUP Logical paths** subtab.
6. Select a logical path and click **Set Current**.

Link Incident Registered Recipient configuration

The Link Incident Registered Recipient (LIRR) receives Link Incident Reports (RLIR) on the source N_Port. The LIRR database is stored on the switch.

Viewing Link Incident Registered Recipient configurations

To display a list of Link Incident Registered Recipient (LIRR) configurations.

1. Select a FICON-enabled switch from the **Fabric Tree**.
2. Select **Configure > Switch Admin**.
3. Click **Show Advanced Mode** to see all the available tabs and options.
4. Select the **FICON CUP** tab.

The **FICON CUP** page displays the **FICON Management Server** page in front. All attributes on this page are read-only until FMS mode is enabled.

5. Click the **Link Incident Registered Recipient** subtab.

Configuring LIRRs

To configure the Link Incident Registered Recipients (LIRR), perform the following steps.

1. Select a FICON-enabled switch from the **Fabric Tree**.
2. Select **Configure > Switch Admin**.
3. Click **Show Advanced Mode** to see all the available tabs and options.
4. Select the **FICON CUP** tab.

The **FICON CUP** page displays the **FICON Management Server** page in front. All attributes on this page are read-only until FMS mode is enabled.

5. Click the **Link Incident Registered Recipient** subtab.
6. Select a port from the list.
7. Click **Set Current**.
8. Click **Close**.
9. *Optional:* The selected port can be reset using the reset button.

Displaying Request Node Identification Data

Web Tools displays Request Node Identification Data (RNID) information for the local switch, and for attached FICON devices and FICON channel paths. RNID information for the switch displays in the **Switch Information** tab (Figure 46).

The screenshot shows the Web Tools interface for switch 128-sw0. The 'Switch Information' tab is active, displaying various system parameters. The 'RNID' section is expanded, showing the following information:

RNID	
Type	SLKWRM
Model	DCX
Tag	02ff
Sequence number	011111111111
Insistent Domain ID Mode	Disabled
Manufacturer	BRD
Manufacturer Plant	CA

FIGURE 46 Switch RNID information

RNID information for attached FICON devices and channel paths displays on the **Name Server** view. To view this information, Click **Name Server** tab to display the **Name Server** view. Ports that completed an RNID exchange display **FICON** in the **Capability** column. For those ports, the following information specific to RNID displays in the following columns:

- Type
- Model
- Tag
- Sequence Number
- Insistent Domain ID Mode
- Manufacturer
- Manufacturer Plant

Configuring FCoE with Web Tools

In this chapter

- Web Tools and FCoE overview 213
- Web Tools, the EGM license, and Brocade Network Advisor 214
- Switch administration and FCoE 215
- FCOE configuration tasks 215
- Quality of Service configuration 215
- LLDP-DCBX configuration 217
- Configuring DCB interfaces 220
- Configuring a link aggregation group 221
- Configuring VLANs 222
- Configuring FCoE login groups 223
- Displaying FCoE port information 223
- Displaying LAG information 224
- Displaying VLAN information 225
- Displaying FCoE login groups 225
- Displaying QoS information 225
- Displaying LLDP-DCBX information 225
- Displaying DCB interface statistics 225
- Configuring a DCB interface from the Switch View 226
- Configuring a DCB interface from the Port Admin panel 226
- Enabling and disabling a LAG 226
- Enabling and disabling LLDP 227
- Enabling and disabling QoS priority-based flow control 227
- Enabling and disabling FCoE ports 227

Web Tools and FCoE overview

Brocade Web Tools is an embedded graphical user interface (GUI) that enables administrators to monitor and manage single or small fabrics, switches, and ports. Web Tools is launched directly from a web browser, or from Brocade Network Advisor.

NOTE

For complete information on Web Tools, refer to the *Web Tools Administrator's Guide*. This chapter only discusses Web Tools and FCoE configuration.

A limited set of features is accessible using Web Tools without a license, and is available free of charge. Additional switch management features are accessible using Web Tools with the Enhanced Group Management (EGM) license. Refer to [“Web Tools, the EGM license, and Brocade Network Advisor”](#) for more information.

A new **view** has been added to Web Tools for the Brocade 8000 switch and FCOE10-24 DCX blade, and new tabs have been added to the **Switch Administration** window and the **Port Admin** tab to support FCoE interfaces and trunks.

Web Tools, the EGM license, and Brocade Network Advisor

Beginning with Fabric OS version 6.1.1, Web Tools functionality is tiered and integrated with Brocade Network Advisor. If you are migrating from a Web Tools release prior to Fabric OS version 6.1.1, this may impact how you use Web Tools.

A Web Tools license is not required, and a basic version of Web Tools is available for free. Additional functionality may be added by obtaining the Enhanced Group Management (EGM) license.

The EGM license is required only for 8 Gbps platforms, such as the:

- Brocade Encryption Switch
- Brocade 300, 5300, and 5100 switches
- Brocade VA-40FC
- Brocade 8000
- Brocade 7800

For non-8 Gbps platforms, all functionalities are available without the EGM license.

Port information that is unique to FCoE

The **General** tab in the **Port Admin** tab displays several parameters that are unique to DCB/DCE interfaces:

- **Interface Mode**—The interface mode values are either **None** or **L2** mode.
- **VLAN ID**—The VLANs that carry traffic on the links are attached to this port.
- **LAG**—The ID of the Link Aggregation Group (LAG), with which this port is associated. If no ID is specified, the port is not associated with any LAG.
- **L2 Mode**—The values are **Access**, **Trunk**, or **Converged**. **Access** mode allows only one VLAN association, and allows only untagged frames. **Trunk** mode allows more than one VLAN association, and allows tagged frames. **Converged** mode interface can be native (untagged or access) in one VLAN and it could be non-native (trunk or tagged) type in more than one VLAN.
- **DCB Map**—The name of a DCB map that was created and associated with the port.
- **Traffic Class Map**—The name of a traffic class map that was created and associated with the port.
- **LLDP Status**—Indicates whether LLDP is active or inactive.
- **LLDP Profile**—The name of an LLDP profile that was created and associated with the port.
- **FCoE Priority Bits**—Each bit represents a user priority that is associated with FCoE traffic.
- **Default CoS**—The default Class of Service.

Switch administration and FCoE

The **DCB** tab on the **Switch Administration** window is specific to DCE and DCB configuration and management. The DCB tab has five subtabs (Figure 47) that are used for FCoE switch administration:

- **Link Aggregation**
- **VLAN**
- **FCoE Login Group**
- **QoS**
- **LLDP-DCBX**

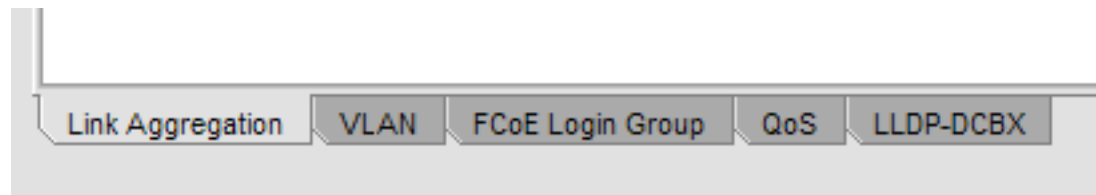

FIGURE 47 Switch Administration DCB subtabs

FCOE configuration tasks

There are several tasks related to FCOE configuration. The following list describes the high level tasks in a suggested order:

- **Quality of Service (QoS) configuration (optional)**—If you intend to implement a specific QoS scheme to prioritize data traffic, it is recommended that you finish your QoS configuration before you begin port configuration. QoS values are referenced when you configure ports.
- **LLDP-DCBX configuration (optional)**—If you intend to implement DCBX, it is recommended that you finish LLDP-DCBX configuration before you configure ports. LLDP-DCBX values are referenced when you configure ports.
- **DCB interface configuration (mandatory).**
- **Link Aggregation Group (LAG) configuration (mandatory)**—Ports must be configured before they can be placed into a LAG. The parameters applied to the LAG reflects on each port that is member of the LAG.
- **VLAN configuration (optional)**—Port and LAG names are referenced in VLAN configuration, and must be defined before you can successfully complete a VLAN configuration.
- **Login group configuration (optional)**—Login group configuration is not dependent on any of the above configurations. It can be done as a separate task.

Quality of Service configuration

As a general concept, Quality of Service (QoS) is a mechanism for classifying and scheduling data traffic based on priority settings. QoS can be used to control traffic congestion, allocate bandwidth, and carry data traffic with different characteristics over a common interface.

The following two configuration options are available:

- You can edit the DCB map. The DCB map defines priority and priority group tables that support Enhanced Transmission Selection (ETS). ETS allows allocation of bandwidth to different traffic classes. DCB maps also allow you to enable Priority Flow Control (PFC).
- You can create a traffic class map. A traffic class map can be used to map a specific class of traffic to a specific Class of Service (CoS).

Editing the DCB map

The DCB map defines priority and priority group tables that support Enhanced Transmission Selection (ETS). ETS allows bandwidth to be allocated based on priority settings through an exchange of priority group tables.

To edit the DCB map, perform the following steps.

1. Select the **DCB tab** on the **Switch Administration** window.
2. Select the **QoS** tab.
3. Select the **DCB Map** tab.
4. Select the default DCB map, and click **Edit**.

The **DCB Map Configuration** dialog box displays.

5. Enter a precedence value in the **Precedence** field.

The value is specified as a number. The allowable range is 1 to 100. The default is 1.

The precedence value controls QoS scheduling policies. The scheduler gives precedence to the highest precedence value.

When the **DCB Map Configuration** dialog box displays, the default values shown in the **Priority Group Map** match the IEEE 802.1Q recommendation for systems supporting eight traffic classes. The **Priority Group Map** displays the Layer 2 **Cos** values mapped to **Priority Group ID** (PGID). PGID values are in the form `<policy>.<priority>`. A policy value of 15 indicates Priority values run from 0 (highest priority) to 7 (lowest priority). Note that this is contrary to the **CoS** values, which run from 7 (highest priority) to 0 (lowest priority).

6. Create a new priority group by clicking **Add** next to the **Priority Group** table.

An entry is added to the **Priority Group** table.

NOTE

When you add an entry, a PGID is automatically assigned. The PGID is an integer from 0 to 7. The first added entry is given a PGID of 0, and the PGID increments by one for each additional added entry until a PGID of 7 is reached.

7. Edit the **Bandwidth** entry to indicate the desired percentage of total bandwidth.
8. Change the **Priority Flow Control Status** to **Enabled** to enable PFC for the entry.
9. Click **OK**.

The new priority group displays in the **Priority Group Map**.

Adding a traffic class map

CoS priorities can be mapped to traffic classes using a traffic class map.

1. Select the **DCB tab** on the **Switch Administration** window.
2. Select the **QoS** tab.
3. Select the **Traffic Class Map** tab.
4. Select **Add**.

The **Traffic Class Map Configuration** dialog box displays.

NOTE

This dialog box has the same structure as the **Priority Group Map** in the **DCB Configuration** dialog box. The default CoS-to-traffic class structure is based on IEEE 802.1Q recommendations, as in the default Priority Group Map.

5. Enter a name for the traffic class map in the **Name** field.
6. Select the **Traffic Class** that you want to assign to the **CoS** priority.
7. Click **OK**.

LLDP-DCBX configuration

Link Layer Discovery Protocol (LLDP) is a IEEE standard for collecting and distributing device information. Data Center Bridging Exchange (DCBX) extends LLDP by providing a protocol for discovering, initializing, and managing DCB-compliant devices.

There are two configuration procedures:

- Configuring global LLDP characteristics.
- Configuring an LLDP profile.

Configuring global LLDP characteristics

Configuring at the global level enables you to apply changes to every port.

To configure the global LLDP characteristics, perform the following steps.

1. Select the **DCB tab** on the **Switch Administration** window.
2. Select the **LLDP-DCBX** tab.
3. Select the **Global** tab.
4. Select the **LLDP** check box to enable LLDP globally.

You can clear the check box to disable LLDP.

5. Enter a name for the configuration in the **System Name** field.
6. Optionally, add a description in the **System Description** field.
7. Select the **Mode**.

For **Mode**, the choices are **Tx** (transmit), **Rx**, (receive) or **Both**. The default is **Both**.

8. In the **Hello** field, enter a time value in seconds.

The Hello value sets the interval between hello bridge protocol data units sent by the root switch configuration messages. The range of valid values is from 4 to 180 seconds. The default is 30 seconds.

9. In the **Multiplier** field, set the number of consecutive misses allowed before LLDP considers the interface to be down.

The range is 2 to 10. The default is 4. The multiplier **is related to the Hello time interval. Using the defaults, you wait four times (the multiplier value) at 30 second intervals (the hello value) before giving up on the interface.**

10. In the **FCoE Priority Bits** field, enter a value that indicates the desired user priority. Each bit represents a user priority associated with FCoE traffic.

The range of valid values is from 0 through 255. The default is 8.

Even though setting multiple bits is allowed (exercising the full range of values), it doesn't make sense to set more than one bit, because adapters don't support multiple priorities for FCoE.

NOTE

Web Tools accepts only decimal values for this option, but the CLI allows only entries in list format or hexadecimal. For example, if you enter the value 8 (decimal) in Web Tools, CLI represents it as 3 in list format. If you enter the value 255 (decimal) in Web Tools, CLI represents it as 0 1 2 3 4 5 6 7 in list format.

11. Select the parameters you want to exchange.

Note that the term TLV indicates packaging of parameters into a Brocade-specific Type/Length/Value (TLV):

- **Advertise Optional-tlv**—Advertises the following optional TLVs:
 - **system-description**—Describes switch or blade characteristics.
 - **port-description**—Describes the configured port.
 - **system-name**—Specifies the system name.
 - **system-capabilities**—Describes the system capabilities.
 - **management-address**—The IP address of the management port on the 8000 switch.
- **Advertise dot1-tlv**—Select this check box to advertise to any attached device to send IEEE 802.1 LLDP type, length, and values.
- **Advertise dot3-tlv**—Select this check box to advertise to any attached device to send IEEE 802.3 LLDP type, length, and values.
- **Advertise DCBx-tlv**—Select this check box to advertise to any attached device the respective LLDP type, length, and values.
- **Advertise DCBx-fcoe-logical-link**—Select this check box to advertise to any attached device to send DCBX protocol over LLDP to negotiate the logical link type, length, and values.
- **Advertise DCBx-fcoe-app**—Select this check box to advertise application type, length, and values to ensure interoperability of traffic over DCBX protocol running over LLDP.

12. Click **Apply**.

13. Click **Save Configuration**.

Adding an LLDP profile

The LLDP profile determines LLDP settings per port.

To add an LLDP profile, perform the following steps.

1. Select the **DCB tab** on the **Switch Administration** window.
2. Select the **LLDP-DCBX** tab.
3. Select the **LLDP Profile tab**.
4. Click **Add**.

The **LLDP Configuration** dialog box displays.

5. Enter a name for the configuration in the **Name** field.
6. Optionally, add a description in the **Description** field.
7. Select the **Mode**.

For **Mode**, the choices are **Tx** (transmit), **Rx**, (receive) or **Both**. The default is **Both**.

8. In the **Hello** field, enter a time value in seconds.

The Hello value sets the interval between hello bridge protocol data units sent by the root switch configuration messages. The range is 4 to 180 seconds. The default is the global configuration range.

9. In the **Multiplier** field, set the number of consecutive misses allowed before LLDP considers the interface to be down.

The range is 2 to 10. The default is the global configuration range. The multiplier **is related to the Hello time interval. Using the defaults, you wait four times (the multiplier value) at 30 second intervals (the hello value) before giving up on the interface.**

10. Select the parameters you want to exchange.

Note that the term TLV indicates packaging of parameters into a Brocade-specific Type/Length/Value (TLV).

- **Advertise Optional-tlv**—Advertises the following optional TLVs:
 - **system-description**—Describes switch or blade characteristics.
 - **port-description**—Describes the configured port.
 - **system-name**—Specifies the system name.
 - **system capabilities**—Describes the system capabilities.

- **management-address**—The IP address of the management port on the 8000 switch.
- **Advertise dot1-tlv**—Advertises to any attached device to send IEEE 802.1 LLDP type, length, and values.
- **Advertise dot3-tlv**—Advertises to any attached device to send IEEE 802.3 LLDP type, length, and values.
- **Advertise DCBx-tlv**—Advertises to any attached device the respective LLDP type, length, and values.
- **Advertise DCBx-fcoe-logical-link**—Advertises to any attached device to send DCBX protocol over LLDP to negotiate the logical link type, length, and values.
- **Advertise DCBx-fcoe-app**—Advertises application type, length, and values to ensure interoperability of traffic over DCBX protocol running over LLDP.

11. Click **Save Configuration**.

Configuring DCB interfaces

The **DCB Interfaces** tab in the **Port Admin** tab is used for configuring the **DCB** interfaces on a switch.

To configure the DCB interfaces, perform the following steps.

1. Select the **DCB Interfaces** tab on the **Port Admin** tab.
2. Select the port you want to configure under the **DCB Interface Explorer**.
3. Select the **General** tab.

Normally, this tab is pre-selected.

4. Select **Edit Configuration**.

The **DCB Edit Configuration** dialog box displays.

5. Select the **Interface Mode**.

The options are **None** and **L2**. The default is **None**.

If you intend to use this port in a Link Aggregation Group (LAG), select **None**. L2 mode is applied when you configure the LAG.

6. Select the **L2 Mode**.

The choices are **Access**, **Trunk**, and **Converged**. The default is **Access**.

The L2 mode setting determines operation within a VLAN:

- **Access** mode allows only one VLAN association, and all frames are untagged.
- **Trunk** mode allows more than one VLAN association, and tagged frames are allowed.
- **Converged** mode interface can be Native (untagged or access) in one VLAN and it could be non-native (trunk or tagged) type in another VLAN.

7. If you are using the DCB map or a Traffic Class Map to apply QoS traffic priority, select the appropriate button, and enter the name of the map you want to use.

For a TenGigabitEthernet port configured as an FCoE port, the default DCB map is applied automatically. You cannot apply the Traffic Class Map to an FCoE port

8. Enter the profile name in the **LLDP-DCBX Profile** field for using a specific profile for the interface.
9. In the **FCoE Priority Bits** field, enter a value that indicates the desired user priority. Each bit represents a user priority that is associated with FCoE traffic.
The range is 0-255. The default is 8.
10. Assign a default class of service in the **Default CoS** field.
The default CoS range is 0-7. The default is 0.
11. Click **OK**.
12. Click **Enable** for **Status** and **LLDP Status**.

Configuring a link aggregation group

FCoE ports can be grouped to create a link aggregation group (LAG). The LAG is treated as a single interface.

To configure a LAG, perform the following steps.

1. Select the **DCB Interfaces** tab on the **Switch Administration** window.
2. Select the **Link Aggregation** tab.
3. Click **Add**.

The **Add LAG Configuration** dialog box displays.

NOTE

Only ports that you defined with an **Interface Mode** of **None** can be a **LAG Member**.

4. Click the **Add** arrow button to move the interfaces to the **Selected List**.
5. Select the **Mode**.

The choices are **Static** and **Dynamic**. **Static** mode does not use Link Aggregation Control Protocol (LACP) to negotiate and manage link aggregation. Link participation in the LAG is determined by the link's operational status and administrative state. **Dynamic** mode uses LACP. LACP allows partner systems to examine the attributes of the links that connect them and dynamically form a LAG. When you select **Dynamic** mode, the **Active** and **Passive** options are enabled:

- If you choose **Active**, your switch initiates an exchange of LACP data units.
- If you choose **Passive**, your switch waits to receive LACP data units from its partner system and then respond. **Passive** is the default behavior.

6. Select the **Type**.

Type refers to the type of trunking used by the LAG. The choices are **Standard** and **Brocade**.

7. Select the **Interface Mode**.

The options are **None** and **L2**. The default is **None**.

8. Select the **L2 Mode**.

The L2 mode setting determines operation within a VLAN:

- **Access** mode allows only one VLAN association, and all frames are untagged.
- **Trunk** mode allows more than one VLAN association, and allows tagged frames.

9. Select the operational **Status**.

The choices are **Administratively Up** and **Administratively Down**.

10. Click **OK**.

Configuring VLANs

The Virtual LAN (VLAN) capability allows multiple virtual LANs within a single physical LAN infrastructure. The physical interface must be configured as L2 prior to configuring a VLAN, either as an individual interface, or as a LAG. Before you start the VLAN configuration procedure, you need to know which interfaces or LAGs you want to associate with each VLAN.

To configure a VLAN, perform the following steps.

1. Select the **DCB** tab on the **Switch Administration** window.
2. Select the **VLAN** tab.
3. Click **Add**.

The **VLAN Configuration** dialog box displays.

4. Specify a VLAN ID.

The format is VLAN<bridge number><ID>. In this Fabric OS release, no bridge instances are supported, so the bridge number is always 0, and the value under **Bridge** is statically defined as VLAN0. The <ID> is an integer from 1 to 3583, that must be entered in the **ID** field.

5. Select the **Native** check box to add all the converged interfaces added in the present operation as native to a VLAN.

NOTE

If you want to modify any converged interface as either native or non-native, you must first remove that particular member from that VLAN and then re-add it to the same VLAN.

6. Under the **Selection List**, click the plus sign (+) next to the **Interface** and **LAG** folders, and select individual interfaces and LAGs you want to associate with the VLAN ID.
7. Click **Add** to move the interfaces or LAGs to the **Selected List**.

Note the reminder that interfaces must be configured as L2, and that the interfaces or LAGs must be in Trunk mode to be associated with multiple VLANs, Access mode interfaces can be associated with only one VLAN, and the Converged mode interface can be Native in one VLAN and it could be non-native type in more than one VLAN.

8. Click **OK**.

9. Repeat the procedure for additional VLANs.

10. To edit VLAN, select the detail from the table in the **VLAN** tab and click **Edit**.

NOTE

The FCoE check box is selected by default for FCoE VLAN. The FCoE check box is read-only, you must use the CLI to make any changes to the FCoE VLAN.

11. Click **OK** to enable FCoE. Clear the check box to disable FCoE.

Configuring FCoE login groups

FCoE login groups control which FCoE devices are allowed to log in to a switch or fabric.

The **FCoE Ports** window is used for configuring the FCoE ports on a switch.

To configure an FCoE login group, perform the following steps.

1. Select the **DCB tab** on the **Switch Administration** window.
2. Select the **FCoE Login Group** tab.
3. Click **New**.

The **New Login Group** dialog box displays.

4. Enter a name for the login group in the **Login Group Name** field.
5. Select the switch WWN.

The choices are:

- **Self** – WWN of your current switch
- **Other Switch WWN**

If you choose **Other Switch WWN**, you must enter the WWN of that switch in the provided field.

6. Under **Login Member Configuration**, select either **Allow All Members** or **Allow Specific Member**.
 - If you select **Allow All Members**, all devices attached to FCoE ports are allowed to log in to the switch.
 - If you select **Allow Specific Member**, you can control which devices can log in, using **Member Type**, **Member PWWN/MAC**, and the **Add** and **Remove** buttons, as described below.
 - a. **Select Model2 as Member Type.**
 - b. Enter the port WWN in hexadecimal format in the **Member PWWN/MAC** field, and click **Add**.

The WWN displays under **Allowed Login Members**. If you decide a member should not be on the list, highlight the entry and click **Remove**.

7. Click **OK**.

Displaying FCoE port information

There are 24 internal FCoE Ports that bridge FC and Ethernet traffic. You can view FCoE port information from the **Port Admin** tab.

To display FCoE port information, perform the following steps.

17 Displaying LAG information

1. Select the **FCoE Ports** tab on the **Port Admin** tab.

The initial view displays a summary of all FCoE ports on the switch ([Figure 48](#)).

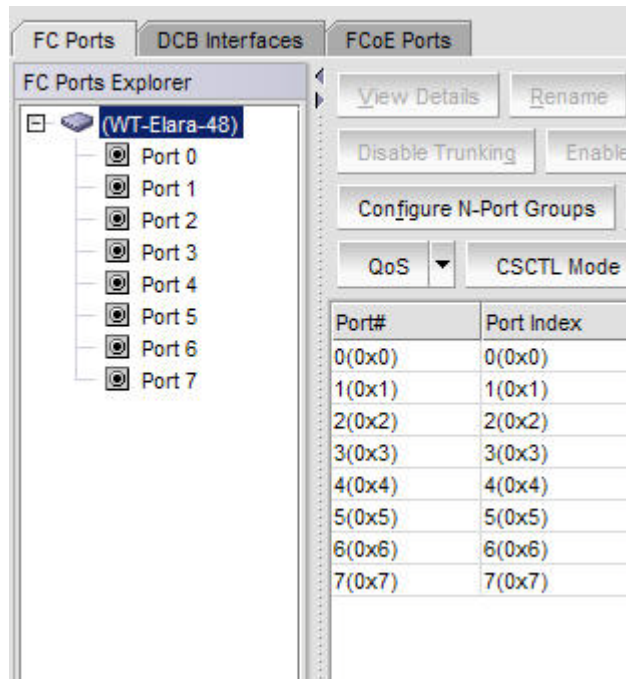

FIGURE 48 FCoE Ports tab, Port Administration panel

2. To view information for a specific port, select the trunk in the **FCoE Ports Explorer** or select the port in the **FCoE Port Configuration and Management** table and click **View Details**.

Port information displays in three tabs. The **General** tab is pre-selected.

The **Connected Devices** tab displays information about devices connected to the switch ([Figure 48](#)). Six columns of information are displayed:

- **Device WWN** displays the WWN of the connected device.
- **Device MAC** displays the MAC address of the connected device.
- **Connected Peer Type** displays the port type on the connected device.
- **Is Directly Connected** indicates whether or not the device is directly connected to the trunk.
- **FCoE Port MAC** displays the FCoE port MAC address.
- **Switch Port** displays the switch port WWN.

Displaying LAG information

To display LAG information, perform the following steps.

1. Select the **DCB** tab on the **Switch Administration** panel.
2. Select the **Link Aggregation** tab.

The LAG information displays.

Displaying VLAN information

To display VLAN information, perform the following steps.

1. Select the **DCB tab** on the **Switch Administration** window.
2. Select the **VLAN** tab.

The VLAN information displays.

Displaying FCoE login groups

To display FCoE login group information, perform the following steps.

1. Select the **DCB tab** on the **Switch Administration** window.
2. Select the **FCoE Login** tab.

The FCOE login group information displays.

Displaying QoS information

To display QoS information, perform the following steps.

1. Select the **DCB tab** on the **Switch Administration** window.
2. Select the **QoS** tab.

From the **QoS** tab, you can select the **DCB Map** tab to display DCB map information, or select the **Traffic Class Map** tab to display traffic class maps information.

Displaying LLDP-DCBX information

To display LLDP-DCBX information, perform the following steps.

1. Select the **DCB tab** on the **Switch Administration** window.
2. Select the **LLDP-DCBX** tab.
 - To display global settings, select the **Global** tab.
 - To display LLDP profile information, select the **LLDP Profile** tab.

Displaying DCB interface statistics

The DCB interface **Port Statistics** tab displays basic and advanced statistics, and allows you to change statistics collection parameters.

The **DCB Interface Statistics Configuration** section allows you to do the following:

17 Configuring a DCB interface from the Switch View

- Toggle between showing **Absolute Values** or **Delta Values** (values that have changed since the last data collection).
- Use the **Clear Counters** button to clear the counters in port statistics.
- Change the retrieval interval.

To view additional information, select **View > Advanced Mode**. An **Advanced** tab and an **Error Detail** tab are added next to **Basic Mode**.

The **Advanced** tab displays DCB transmission statistics, and the **Error Details** tab displays transmission error statistics.

To display DCB interface statistics, perform the following steps.

1. Select the **DCB Interfaces** tab on the **Port Admin** tab.
2. Under the **DCB Interface Explorer**, select a port.
3. Select the **Port Statistics** tab.

Configuring a DCB interface from the Switch View

DCB interfaces can be enabled and disabled from a right-click menu on the **Switch View**.

To enable or disable a DCB interface from the **Switch View**, perform the following steps.

1. Right-click the port to display the right-click menu.
2. Select **Configure** to display the **Enable** and **Disable** options.

Configuring a DCB interface from the Port Admin panel

DCB interfaces can be enabled and disabled from the **Port Admin** tab.

To enable or disable a DCB interface from the **Port Admin** tab, perform the following steps.

1. Select the **DCB Interfaces** tab on the **Port Admin** tab.
2. Under the **DCB Interface Explorer**, select the port you want to enable or disable.
3. Select the **General** tab.

This tab is normally pre-selected. You can follow either of the following options to enable or disable the interface:

- Click **Enable Interface** or **Disable Interface** to enable or disable the interface, as desired.
- Click **Edit Configuration** to open the **DCB Edit Configuration** dialog box. Select **Enable** or **Disable** for the **Status** field to enable or disable the interface.

Enabling and disabling a LAG

To enable or disable a LAG, perform the following steps.

1. Select the **DCB** tab on the **Switch Administration** window.
2. Select the **Link Aggregation** tab.

3. Click **Add**.
The **LAG Configuration** dialog box displays.
4. Change the **Status** to **Administratively Up** or **Administratively Down**.

Enabling and disabling LLDP

To enable or disable LLDP on a DCB interface, perform the following steps.

1. Select the **DCB Interfaces** tab on the **Port Admin** tab.
2. Under the **DCB Interface Explorer**, select the port.
3. Select the **General** tab.
4. Click **Edit Configuration**.
The **DCB Edit Configuration** dialog box displays.
5. For the **LLDP Status option**, select **Enable** or **Disable**.

Enabling and disabling QoS priority-based flow control

Priority-based flow control (PFC) can be used to control network congestion. PFC can be used to selectively pause lower priority traffic classes to ensure that high priority and delay-sensitive traffic are not affected by network congestion. For example, if a large storage transfer is monopolizing the network and causing congestion, PFC can be used to pause the storage transfer so other traffic may use the network.

To enable or disable PFC, perform the following steps.

1. Select the **DCB tab** on the **Switch Administration** window.
2. Select the **QoS** tab.
3. Select the **DCB Maps** tab.
4. Under the **Priority Group area**, enable or disable **Priority Flow Control Status** option for each **Priority Group ID**.

Enabling and disabling FCoE ports

You can enable and disable FCoE Ports individually from the **Port Admin** tab.

1. Select the **FCoE Ports** tab on the **Port Admin** tab.
2. Select the port you want to enable or disable under the **FCoE Ports Explorer**, or from the list.
3. Click **Enable** or **Disable** to change the current status of the port.

You can also enable or disable by clicking **Edit Configuration**, and selecting **Enable** or **Disable** on the **FCoE Edit Configuration** dialog box.

17 Enabling and disabling FCoE ports

Limitations

In this chapter

- [General Web Tools limitations](#) 229

General Web Tools limitations

Table 21 lists general Web Tools limitations that apply to all browsers and switch platforms.

TABLE 21 Web Tools limitations

Area	Details
Blade Failure	If a blade fails on the switch, the Web Tools interface can still display slot and ports as healthy. In this case, the failure might not be visible in Web Tools until the Web Tools window is reopened.
Browser	For Internet Explore 7.0, the default setting is to disable Telnet functionality. You must make the appropriate changes in the registry to enable Telnet functionality if you want to use it. Launching the default Telnet is not supported in Windows Vista and Windows 2008 server.
Browser	Fabric Watch, Switch Admin, HA, Name Server, and Zone Admin are separate applets embedded in HTML pages. The successful launch of the applet depends on whether the browser can successfully load the HTML page. Very occasionally, a blank browser window displays with the message “loading pages...” that is stuck. This is likely caused by a sudden loss of switch Web server (either by normal HA failover, restart, or other causes). Workaround: If Fabric Watch, Switch Admin, HA, Name Server, or Zone Admin hang, close this window and relaunch the module.
Browser	A Web Tools browser window might stop responding following an HA failover immediately after a zoning configuration was enabled or disabled. It is likely that the Web daemon was terminated by the HA failover before the HTTP request was sent back. Workaround: If one of the Web Tools modules is hanging, close the window and relaunch the module. If the module is locked, shut down and relaunch the Web Tools application.
Browser	When you launch Fabric Watch , Switch Admin , Name Server , and Topology from Switch Explorer through Internet Explorer, the applet windows cannot be resized and the Maximize button is disabled.
Chassis not ready for management	If the switch is still in the process of booting and you try to launch the Web Tools by entering the IP address, this message displays in the browser. You should wait for the switch to finish the startup sequence.
Configuration	Web Tools does not support NAT router configurations and does not function correctly with switches behind a NAT router.

TABLE 21 Web Tools limitations (Continued)

Area	Details
Firmware download	<p>There are multiple phases to firmware download and activation. When Web Tools reports that firmware download completed successfully, this indicates that a basic sanity check, package retrieval, package unloading, and verification was successful. Web Tools forces a full package install.</p> <p>A restart is required to activate the newly downloaded firmware. This restart is done automatically; however, although Web Tools screens continue to display during the restart, they are not available. Wait approximately 10 minutes to ensure that all of the application windows are restored. If Web Tools fails to respond after 20 minutes, you might need to close all Web Tools applications windows and restart them, or to contact your system administrator for network assistance.</p> <p>The Web Tools loss of network connectivity during a failover or restart (initiated through the firmwareDownload) varies for different configurations:</p> <p>Brocade DCX and DCX-4S enterprise-class platforms: loss of network connectivity is up to 5 minutes if the power-on self-test (POST) is disabled. If POST is enabled, the loss of network connectivity can exceed 5 minutes.</p> <p>Brocade 300, 5100, 5300, 6510, 6520, 7800, 8000, VA-40FC, and the Encryption Switch: Loss of network connectivity is up to 1 minute if POST is disabled. If POST is enabled, the loss of network connectivity can exceed 1 minute.</p>
Firmware downgrade	<p>If you try to run Web Tools on a switch after downgrading the firmware, Web Tools may not open. This is due to the presence of old application cache files in Java. The workaround is to delete the application cache files using the Java Control Panel.</p> <p>After upgrading or downgrading the firmware, delete the application cache files.</p>
HTTP timeout	<p>Occasionally, you might see the following message when you try to get data from a switch or to send a request to the switch:</p> <p>Failed to get switch response. Please verify the status of your last operation and try again if necessary.</p> <p>This indicates that an HTTP request did not get a response. The request was sent to the switch, but the connection was down, probably caused by a temporary loss of the Web server on the switch. Due to the nature of an HTTP connection, Web Tools reports this error after a 90-second default timeout.</p> <p>In this case, verify the status of your last request, using Telnet to check related status, or click the Refresh button from the Web Tools application you were working on to retrieve related data. If your request did not get through to the switch, resubmit it. Executing a refresh from Web Tools retrieves a copy of switch data at that moment; the data you entered can be lost if it had not already committed to the switch.</p>
Inband management support	<p>Fabric OS v7.1.0 supports Web Tools, SNMP polling, and SNMP traps only in IPv4 on the Brocade 7800 and FX8-24.</p>
Java cache	<p>If the Web Tools progress bar stops at 93 percent when initializing switch details, you must clear the Java cache, as described in “Deleting temporary internet files used by Java applications” on page 6.</p>
Java Plug-in	<p>If you have a Web Tools session open and you open a second session using the File > New browser menu, this results in unexpected behavior of the original Web Tools session.</p> <p>Web Tools supports only one browser instance per JRE, and when you open another window using the File > New menu, the two windows share the same JRE environment.</p> <p>Workaround: Open two independent browser sessions.</p>

TABLE 21 Web Tools limitations (Continued)

Area	Details
Loss of Connection	<p>Occasionally, you might see the following message when you try to retrieve data from the switch or send a request to the switch:</p> <p>Switch Status Checking The switch is not currently accessible.</p> <p>The dialog box title may vary, because it indicates which module is having the problem. This is caused by the loss of HTTP connection with the switch, due to a variety of possible problems. Web Tools automatically tries to regain the connection. While Web Tools is trying to regain the connection, check if your Ethernet connection is still functioning. If the problem is not with the Ethernet connection, wait for Web Tools to recover the connection and display the following message:</p> <p>“You will have to resubmit your request after closing this message.”</p> <p>If the temporary switch connection loss is caused by switch hot code load, or other similar operation, Switch Explorer you are currently running can be downloaded from a different firmware version than the new one. In this case the following message displays:</p> <p>“Switch connection is restored. The firmware version you are running is not in sync with the version currently on switch. Close your browser and re-launch Web Tools.”</p> <p>You need to close Switch Explorer and relaunch Web Tools to reopen the connection.</p>
Non-FIPS secure mode HTTPS	<p>HTTPS supports only TLSv1 and SSLv3 protocols with !DH:HIGH:-MD5 cipher in non-fips mode. These options must be enabled in your internet browser.</p>
Out of Memory Errors	<p>If you are managing fabrics with more than ten switches or more than 1000 ports, or if you are using the iSCSI Gateway module extensively, you might encounter out-of-memory errors such as the following:</p> <p>java.lang.OutOfMemoryError: Java heap space</p> <p>To avoid this problem, increase the default heap size in the Java Control Panel. Refer to “Java plug-in configuration” on page 8 for instructions.</p>
Performance Monitor	<p>If the Web browser crashes or the Performance Monitor license is lost while the Performance Monitoring window is running, some of the Performance Monitor resources owned by Web Tools might not be cleaned up correctly.</p> <p>Workaround: You might need to use the CLI to manually delete these counters. For example, if you detect Web Tools owned resources (using perfshoweemonitor), but you have verified that no Web users are actually using them, use the perfdeleemonitor or perfcleareemonitor command to free the resources.</p>
Performance Monitor	<p>The Switch Throughput Utilization, Switch Percent Utilization, and Port Snapshot Error graphs displays the faulty/powered off slot node in the Y-Axis of the graph.</p> <p>Workaround: Launch any port selection dialog box and load the graphs accordingly.</p>
Refresh option in browsers	<p>When a pop-up window requesting a user response is pushed into the background and a refresh is requested, a fatal Internet Explorer error might occur.</p> <p>Workaround: Restart the browser.</p>
Refresh option in browsers	<p>Web Tools must be restarted when the Ethernet IP address is changed using the NetworkConfig View command. Web Tools appears to hang if it is not restarted after this operation is executed.</p> <p>Workaround: Restart the browser.</p>
Refresh option in browsers	<p>If you change the switch name or domain ID using the CLI after the Web Tools Switch Administration window has started, the new switch name or domain ID is not updated on the header of the Switch Administration page. Clicking the Refresh button does not fix the problem.</p> <p>Workaround: Click the Switch tab and the Switch Administration header updates.</p>

TABLE 21 Web Tools limitations (Continued)

Area	Details
Refresh option in browsers	<p>If you change the switch name using the Web Tools Switch Administration page or SNMP and then open a Telnet window to verify the name change, the CLI prompt (for example, switch:admin >) displays the previous name. The Telnet prompt cannot pick up the new switch name until the switch is fastbooted.</p> <p>Workaround: In order to display the correct switch name in the CLI prompt after a switch name update using Web Tools or SNMP, fastboot the switch.</p>
Refresh option in browsers	<p>Following a switch enable or disable, you must wait at least 25 to 30 seconds for the fabric to reconfigure and for FSPF route calculations to complete before requesting routing information. If accessed too early, routing information are not shown.</p> <p>Workaround: Following a switch enable or disable, wait at least 25–30 seconds before further action.</p>
Refresh option in browsers	<p>The Web Tools Switch Explorer might continue to display a switch from the Switch View, even when the switch has been removed from the fabric.</p> <p>Workaround: If this behavior is seen, relaunch Switch Explorer. If the switch was removed from the fabric, the Fabric View window lists the switch as unavailable.</p>
Refresh option in browsers	<p>In the Switch Administration window, Switch tab, if you click the Refresh button, you might not be able to click the data entry fields to enter text. This behavior occasionally happens on a notebook or laptop computer; it rarely happens on a desktop computer.</p> <p>Workaround: If this happens, you should close the browser window and restart it.</p>
Switch Explorer closure	<p>If a session times out or you exit or close Switch Explorer window, all other windows belonging to the session are invalidated. After a short delay these windows become unusable, but are not closed automatically. You must manually close these windows.</p>
Switch View	<p>Occasionally, switches might display the port icons correctly, but be missing one or more control button icons.</p> <p>Workaround: Close the Switch View of the switch and reopen it.</p>
Windows Operating Systems	<p>Occasionally, you will not see the “Lost connection to the switch” message on the Switch View, even though the Ethernet connection has been lost. You might still be able to invoke various features from Switch View, such as Status, Fan Temp, Power, and Beacon.</p> <p>Workaround: Verify Ethernet connection to the switch by pinging the logical switch IP address.</p>

Index

Numerics

2 domain/4 domain fabric licenses, 9
7800 switch, 69, 70

A

Access Control List. *Refer to* ACL
access control. *Refer to* RBAC.

Access Gateway mode

- configuration, 139
- disable, 142
- enable, 141

- F_Port trunk groups, 87

accessing switch event report, 49

activating

- Allow / Prohibit Matrix configuration, 209
- licenses, 43
- Ports on Demand, 71

adding

- performance graphs to a canvas, 101
- zone alias members, 110
- zone configuration members, 116
- zone members, 112

Admin Domains

- assigning administrators, 167

aliases, zone. *Refer to* zone aliases

all access zoning, 105

Allow / Prohibit Matrix configuration

- activating, 209
- copying, 209
- deleting, 210
- displaying, 207, 211

Allow / Prohibit Matrix configuration

- displaying, 210

arbitrated loop parameters, configuring, 42

automatic trace dump transfers, 124

B

backbone fabric ID, configuring, 137

backing up configuration file, 55

basic performance monitoring graphs, 94, 95

BB credit, 40

beaconing, enabling, 52

best practices for zoning, 122

blades, enabling and disabling, 33

browsers

- limitations, 229, 232
- refresh frequency, setting, 5
- supported, 4

buffer-limited ports, 151

C

changing

- domain ID, 37
- passwords, 168
- switch name, 36

class F traffic, 41

clearing temporary internet files, 6

clearing the zoning database, 122

closing

- sessions, 13

code page, displaying, 205

configuration

- Access Gateway mode, 139
- upload, 141

configuration file

- backing up, 55
- restoring, 56

- configuring
 - Allow / Prohibit Matrix, 206
 - arbitrated loop parameters, 42
 - backbone fabric ID, 137
 - default heap size, 8
 - EX_Ports, 134
 - fabric parameters, 40
 - FAN frame notification parameters, 42
 - FC ports, 64
 - FCR router cost, 136
 - FICON Management Server parameters, 203
 - IOD frames delivery, 160
 - Java Plug-in, 8
 - link cost, 160
 - long-distance settings, 154
 - port speed, 64
 - port type, 64
 - ports, 59
 - RADIUS server, 183
 - routes, 157
 - syslog IP address, 32
 - system services, 42
 - virtual channel settings, 41
- configuring FCR router port costs, 136
- Control Device state, 205
- Control Unit Port. *Refer to CUP*
- copper GigE, 69, 70
- copying Allow / Prohibit Matrix configuration, 209
- CP failover, initiating, 47
- creating
 - basic performance graphs, 94
 - SCC/DCC policy, 174
 - SCSI command graphs, 98
 - SCSI vs. IP traffic graphs, 98
 - SID-DID performance graphs, 97
 - zone aliases, 109
 - zone configurations, 116
 - zones, 111
- creating FCS policy, 174
- customizing basic performance graphs, 95

D

- datafield size, 41
- default zoning, 105

- deleting
 - Allow / Prohibit Matrix configuration, 210
 - user accounts, 167
 - zone aliases, 111
 - zone configurations, 117
 - zones, 114
- device probing, 41
- devices only view, 109
- devices only zoning, 109
- disabling
 - Access Gateway mode, 142
 - automatic trace uploads, 125
 - blades, 33
 - dynamic load sharing, 159
 - FICON Management Server mode, 203
 - ports, 68, 69
 - RADIUS, 183
 - RLS probing, 42
 - switch, 35
 - trunking mode, 85
 - zone configurations, 118
 - zoning, 118
- displaying
 - Allow / Prohibit Matrix configuration, 207, 210, 211
 - Control Device state, 205
 - enabled zone configuration, 119
 - fan status, 126
 - FICON code page, 205
 - name server entries, 50
 - power supply status, 127
 - switch events, 49
 - temperature status, 126
 - user account information, 165
- DLS, 159
- domain ID, changing, 37
- downloading
 - configuration file, 56
 - firmware, 57
- Dynamic Load Sharing. *Refer to DLS*

E

- E_D_TOV, 40
- edge fabrics, 131
- EGM licensed features
 - FICON CUP, 201
 - Performance Monitoring, 18
- enabled zone configuration, displaying, 119

- enabling
 - Access Gateway mode, 141
 - automatic trace dump transfer, 124
 - beaconing, 52
 - blades, 33
 - DLS, 159
 - FICON Management Server mode, 203
 - insistent domain ID mode, 41
 - ports, 68
 - Ports on Demand, 71
 - RADIUS, 183
 - RLS probing, 42
 - switch, 35
 - trunking mode, 85
 - zone configurations, 118
- ending sessions, 13
- events
 - displaying, 49
 - filtering, 49
 - severity levels, 47
- EX_Ports, configuring, 134
- exchange-based routing, 157, 159
- expiring passwords, 169
- extended fabrics, 151

F

- F_Port trunk groups
 - Access Gateway mode, 87
- fabric ID, configuring, 137
- fabric information, refreshing, 107
- fabric parameters, configuring, 40
- Fabric Tree, 20
- fabric view, 109
- fabric view zoning, 109
- Fabric Watch
 - about, 149
- failover, initiating, 47
- FAN frame notification parameters, configuring, 42
- fan status, 126
- fast boot, 38
- FC ports, configuring, 64
- FC Routing module, 133
- FC-FC routing
 - about, 131
 - setting up, 132
 - supported switches, 132
- FCR router cost, 136

- FCS policy
 - activate, 175
 - create, 174
 - deactivate, 175
 - delete, 175
 - distribute, 175
 - moving switch position, 176
- feature licenses, 43
- FICON Management Server
 - mode, enabling and disabling, 203
 - parameters, 203
- filtering events, 49
- Filtering IP Addresses, 33
- firmware download, 57
- FSPF routing, 158
- fwdl. *Refer to* firmware download.

G

- GigE
 - media type, 69, 70
- graphs for performance monitoring, 90
- GUI
 - preferences, 19

H

- HA. *Refer to* High Availability
- hard zones, 109
- heap size, configuring, 8
- High Availability, 45
- HTTPS protocol, 10, 231

I

- ID_ID mode
 - about, 41
 - enabling, 41
- inactivity timeout, 14
- initiating CP failover, 47
- in-order delivery. *Refer to* IOD
- insistent domain ID mode
 - about, 41
 - enabling, 41

- installing
 - Java Plug-in, 7, 8
 - JRE, 7
 - JRE patches on Solaris, 7
 - Solaris patches, 7
- Internet Explorer 7.0, 27
- IOD, frame delivery, 160
- IP address
 - filtering, 33
- ISL trunking, 85

J

- Java Plug-ins
 - configuring, 8
 - installing, 7, 8
 - supported, 4
- JRE, installing, 7

L

- launching
 - FC Routing module, 133
 - Web Tools, 10
- LEDs, port, 130
- licensed features, 43
- licenses
 - activating, 43
 - removing, 44
- limitations
 - browsers, 229, 232
 - firmware download, 230
 - HTTP, 230, 231
 - Microsoft Windows Operating System, 232
 - Performance Monitor, 231
 - Switch View, 232
- limited switch license, 9
- link cost, 160
- logging out, 13
- LSAN
 - devices, 136
 - fabrics, managing, 134
 - zones, managing, 136

M

- managing RADIUS server, 182, 185, 187

- media type
 - GigE, 69, 70
- message severity levels, 47
- MetaSAN, 131
- modifying
 - performance graphs, 101
 - RADIUS server, 184
 - RADIUS server order, 185
 - zone aliases, 110
 - zone configurations, 116
 - zones, 112
- monitoring performance, 89
- mouse over information, 24

N

- name server entries, displaying, 50
- naming ports, 67
- no access zoning, 105
- non-FIPS, 231
- NPIV ports
 - disable, 70
 - enable, 70

O

- opening
 - Performance Monitoring window, 94
 - Switch Administration window, 31
- optical GigE, 69, 70

P

- passwords
 - changing, 168
 - expiring, 169
 - rules, 169
 - unlocking, 170
- performance graphs
 - adding to a canvas, 101
 - modifying, 101
 - printing, 101
 - types of, 90
- Performance Monitoring window, 94
- per-frame routing priority, 41
- persistently disable a port, 69
- platforms, supported, 4

- polling rates, 26
- port menu, 25
- port names, assigning, 67
- port speed, configuring, 64
- port swapping, 75
- port type, configuring, 64
- port-based routing, 157
- ports
 - buffer-limited, 151
 - configuring, 59
 - disabling, 68, 69
 - enabling, 68
 - LEDs, 130
 - long distance parameter, 154
 - naming, 67
- Ports on Demand, enabling, 71
- power supply status, 127, 128
- preferences
 - persist, 19
- printing
 - effective zone configuration, 120
 - performance graphs, 101
- protocol options, 231

R

- R_A_TOV, 40
- RADIUS server
 - about, 182, 185, 187
 - configuring, 183
 - enabling and disabling, 183
 - modifying, 184
 - modifying server order, 185
 - removing, 185
- RAM requirements, 5
- RBAC, pre-defined roles, 13
- rebooting the switch, 38
- recommendations
 - configuration tasks, 27
 - for Web Tools, 26
 - for zoning, 122
- refresh frequency, setting, 5
- refresh rates, 26
- refreshing
 - fabric information, 107
 - Zone Admin window, 108

- removing
 - licenses, 44
 - RADIUS server, 185
 - zone alias members, 110
 - zone configuration members, 116
 - zone members, 112
- renaming
 - zone aliases, 111
 - zone configurations, 117
 - zones, 113
- replacing a WWN in zoning database, 121
- requirements, Web Tools, 4
- restoring configuration file, 56
- right-click menu, 25
- RLS probing, enabling and disabling, 42
- Role-Based Access Control. *Refer to RBAC*
- router cost path, 136
- routes, configuring, 157

S

- saving
 - performance graphs, 100
 - zoning changes, 108
- SCC/DCC policy
 - activate, 175
 - create, 174
 - deactivate, 175
 - delete, 175
 - edit, 174
- SCSI command graph, 98
- SCSI vs. IP traffic graph, 98
- searching zone member selection lists, 121
- sequence level switching, 41
- session management, 14
- sessions, ending, 13
- setting
 - refresh frequency, 5
 - SNMP trap levels, 180
- severity levels, 47
- SID-DID performance graph, 97
- SNMP trap levels, 180
- Solaris patches, installing, 7
- SSLv3, 231
- starting Web Tools, 10
- swapping port index IDs, 75

- switch
 - 7800, 69, 70
 - changing the name of, 36
 - enabling and disabling, 35
 - mouse over information, 24
 - rebooting, 38
- Switch Administration window, 29
 - opening, 31
- Switch Events and Switch Information, 23
- switch events, displaying, 49
- switch name, changing, 36
- switch report, 37
- switch status report, 128
- Switch View, 21
- Switch View buttons, 21
- syslog IP address
 - configuring, 32
 - removing, 32
- system services, configuring, 42

T

- Telnet, 27
- temperature status, 126
- temporary internet files, 6
- timeout, session, 14
- TLS, 231
- trace dumps, 123
- transition, partial Web Tools functions to Brocade Network Advisor, 3
- troubleshooting
 - Web Tools, 26
- trunking mode, enabling and disabling, 85

U

- unlocking passwords, 170
- user accounts, managing, 163
- user-defined roles
 - guidelines and restrictions, 170

V

- value line licenses, 9
- VC Priority, 41

- viewing
 - EX_Ports, 134
 - LSAN devices, 136
 - LSAN fabrics, 134
 - LSAN zones, 136
 - swapped ports, 75
 - Switch Explorer, 17
 - switch status, 127
- viewing FCR router cost, 136
- virtual channel settings, configuring, 41

W

- Web Tools
 - Access Gateway mode, enable, 141
 - GUI preferences, 19
 - launching, 10
 - partial function transition to Brocade Network Advisor, 3
- WWN
 - adding to zones, 120
 - removing from zones, 120
 - replacing in zones, 121

Z

- Zone Admin window
 - about, 105
 - refreshing, 108
 - saving changes, 108
- zone aliases
 - creating, 109
 - deleting, 111
 - description, 109
 - modifying, 110
 - renaming, 111
- zone configurations
 - creating, 116
 - deleting, 117
 - disabling, 118
 - enabling, 118
 - example, 115
 - modifying, 116
 - renaming, 117
- zone member selection lists, searching, 121

zones

- about, 103
- adding WWNs, 120
- best practices, 122
- creating, 111
- deleting, 114
- description, 111
- LSAN, 136
- modifying, 112
- removing WWNs, 120
- renaming, 113
- replacing WWNs, 121
- selecting a view, 109

zoning

- all access, 105
- default zoning, 105
- no access, 105

zoning database

- clearing, 122
- maximum size, 108, 118

zoning views, 109

zoning, disabling, 118

zoning, saving changes, 108

